

Catálogo de Produtos



Televendas
(19) 3238-8082 / 3238-8094



CATÁLOGO ONLINE













www.nckdistribuidora.com.br



Índice



	Página
Política de Comercialização - Prazos e Descontos	186
Canais de Comunicação	210

Produto	Página		Produto	Página
Abraçadeiras (Rosca, Parafuso, Pressão, Elástica/Nylon etc)	57	NCK	Fios de Som / Fios Cabinho	14
Acendedor de Cigarros	205		Fita Isolante	14
Alojamento / Luvas para Terminais de Fio	13		Flanges / Tampas do Módulo de Combustível	105
Amortecedores do Porta-Malas	194		Flautas para Bicos Injetores	116
Anel de Vedação da Bobina de Ignição	89	NCK	Flexíveis de Freio	145
Arruelas dos Bujões do Carter	88		Funil	193
Atuador de Marcha Lenta / Motor de Passo	43		Fusíveis Diversos	11
Bobinas de Ignição à Óleo	25		Garfo de Embreagem Linha Hyundai	138
Bobinas de Ignição Injeção Eletrônica	20	NCK	Garfo de Embreagem Linha Peugeot/Citroën	128
Bombas de Combustível Carburados	31 / 74		Garfo de Engrenagem de Marchas	131
Bombas de Combustível Injeção Eletrônica	39		Garras de Bateria	204
Bombinhas Partida a Frio / Lavador Para-Brisa	32		Graxas Grafitada / Azul	193
Bujões do Carter	87		Guarnição/Borrachinha Bombinha partida à frio / Lavador Para-Brisa	89
Buzinas	17		Guarnições da Bomba de Combustível	91
Cabos de Transferência / Cabo Chupeta	204	NCK	Guias da Vareta de Óleo	60
Cabos Positivos da Bateria	16		Lâmpadas - Toda a Linha Automotiva	4
Caixas de Direção Mecânica	161		Liames do Trambulador Linha GM	121
Calotas do Cubo de Roda	192		Macacos Joelho, Sanfona, Garrafa etc	207
Carcaça da Válvula Termostática e Bomba d'água	73	NCK	Mangueiras (Lonadas, Injeção, Cristal, Capa-Mola, Tecalon, Hidrovácuo etc)	63
Carregadores de Bateria	204		Mangueiras Corrugadas da Bomba de Combustível	92
Carvão do Distribuidor	26		Mangueiras do Filtro de Ar	65
Cebolão / Interruptores Térmicos	19		Mangueiras do Retorno da Água do Radiador	62
Chaves / Botões	12 / 208	NCK	Mangueiras do Retorno da Flauta de Combustível	61
Chaves de Roda em L / Cruz	206		Módulos de Ignição	18
Chaves de Vela	206		Molas do Acelerador	77
Chicotes / Conectores - Injeção, Bobinas, Sensores, Lâmpadas etc	50		Orings do Bico Injetor	37
Cilindros de Roda/Freio	150	NCK	Palhetas do Limpador do Para-Brisa	196
Coifas / Reparos do Semi-Eixo (Lado Câmbio/Roda)	166		Pendentes com Lâmpadas em Led	204
Componentes Injeção Monoponto	33		Ponta Cabo Seletor Linha Fiat	131
Conectores / Engate Rápido (Filtros de Combustível, Flanges etc)	59		Porcas da Bomba de Combustível	100
Conectores Terminal de Fio	13	NCK	Porta Fusíveis	11
Conexões / Adaptadores / Prolongadores Módulo de Combustível	60		Pré-Filtros da Bomba de Combustível	107
Copo do Filtro de Óleo Linha Peugeot/Citroën	129		Prolongador de Bico Injetor	60
Cordoalhas / Cabo Negativo da Bateria	16		Regulador de Pressão	37
Dedais / Vedação de Água	72	NCK	Regulador de Voltagem	18
Desborbulhadores / Separador de Vapor	72		Relés	19
Diafragmas / Regulador de Pressão - Injeção Monopoint	33		Reparo da Alavanca Linha VW	131 / 143
Diafragmas da Tampa de Válvula	34		Reparo Trambulador Linha Renault	132
Distribuidor de Ignição Completo	30	NCK	Reparos / Junta / Kit de Carburadores	75
Diversos	192		Reparos / Junta / Kit de Carburadores Completos (com Bóia e Agulha)	78
Espaguete Termo-Retrátil p/ Fios / Conectores	14		Reparos / Junta / Kit Injeção Eletrônica/TBI	82
Filtros de Combustível Injeção/Carburados	85		Reparos / Kit da Barra Estabilizadora	163





Produto	Página	
Reparos da Alavanca do Câmbio Linha GM	122	
Reparos / Tela do Bico Injetor - Monopoint	33	N C K
Reparos / Tela do Bico Injetor - Multipoint	91	
Reparos da Seleção de Marchas Linha Ford	132	
Reservatório de Partida à Frio etc	71	
Rolamentos de Roda / Alternador etc	171	N C K
Rotor do Distribuidor de Ignição	26	
Selos do Bloco do Motor, Cabeçote etc	86	
Sensores de Rotação	40	
Sensores de Temperatura	19	N C K
Soquetes de Lâmpadas	12	
Suportes do Radiador Linha GM	125	
Suportes do Radiador Linha VW	137	
Tampas do Distribuidor de Ignição	26	N C K
Tampas do Radiador, Óleo, Reservatório de Expansão, Para-Brisa etc	66	
Tampas do Tanque de Combustível	70	
Tela Filtrante Carburador	77	
Tensores / Polias da Correia Dentada, Alternador etc	175	N C K
Terminais de Bateria	16	
Terminais de Fio	13	
Tirantes Externo do Cambio Linha Fiat	142	
Tirantes Externo do Cambio Linha Peugeot/Citroën	127	N C K
Trava para Bicos Injetores	60	
Tubo Corrugado Articulável para Fios	15	
Válvulas Solenoides (Partida à Frio)	31	
Vedador do Tudo da Vareta de Óleo	89	

Catálogo de Produtos



NCK
DISTRIBUIDORA DE PEÇAS
AUTOMOTIVAS

Tele vendas
(19) 3238-8082 / 3238-8094

CATÁLOGO ONLINE

www.nckdistribuidora.com.br

**Está disponível em nosso site
o Catálogo de Produtos
Completo em PDF:
www.nckdistribuidora.com.br**





Lâmpadas



 <p>L-1141 1141 - 1 Polo 21W - 12V Pisca ou Ré</p>	 <p>L-1141C 1141 - 1 Polo 21W - 24V Pisca ou Ré</p>	 <p>L-1141A 1141 Ambar 1 Polo 21W-12V Pisca/ Seta</p>	 <p>L-1141R 1141 Red 1 Polo 21W - 12V Freio</p>
 <p>L-1056 1 Polo 21W - 12V Pino em "V" (Vectra)</p>	 <p>L-1057 1 Polo Ambar 21W-12V Pino em "V" (Vectra)</p>	 <p>L-1034 1034 - 2 Polos 21/5W - 12V Lanterna - Freio</p>	 <p>L-1034C 1034 - 2 Polos 21/5W - 24V Lanterna - Freio</p>
 <p>L-1034A 1034 Ambar 2 Polos 21/5W Lanterna - Seta</p>	 <p>L-1034R 1034 Red 2 Polos 21/5 - 12V Lanterna-Freio</p>	 <p>L-7225 2 Polos 21/5W - 12V Pino em "V" (Vectra)</p>	 <p>L-7225A 2 Polos Ambar 21/5W - 12V Pino em "V" (Vectra)</p>
 <p>L-1176 1176 - 2 Polos 21/5W - 12V (Pino Encontrado)</p>	 <p>L-1156 21W - 12V - Wedge - 1 Pólo Honda Civic (Pisca/Ré) Corolla (Neblina)</p>	 <p>L-1156A 21W - 12V - Ambar - Wedge 1 Polo Honda Civic (Pisca/Ré), Corolla (Neblina)</p>	 <p>L-1157 21/5W - 12V -Wedge - 2 Polos Honda Civic (Lanterna/ Freio)</p>
 <p>L-1157A 21/5W- 12V- Ambar - Wedge 2 Polos Honda Civic (Lanterna/ Freio)</p>	 <p>L-3156 27W - 12V - Base Plástica Honda Civic (Pisca/Ré), Corolla (Neblina)</p>	 <p>L-3156A 27W-12V- Ambar - Base Plástica Honda Civic (Pisca)</p>	 <p>L-3157 27/7W - 12V - Base Plástica Honda Civic (Lanterna/ Freio)</p>
 <p>L-3157A 27/7W-12V-Ambar-Base Plástica H. Civic (Lanterna/ Freio)</p>	 <p>L-75 75 Painel - 12V</p>	 <p>L-67/5 67 5W - 12V</p>	 <p>L-67/10 67 10W - 12V</p>





Lâmpadas



 L-67/10R 67 10W - 12V - Red	 L-69 69 5W - 12V	 L-69A 69 5W - 12V - Azul	 L-TB Lâmpada Torpedo Besta 10W - 12V - Med.: 10X31
 L-6461 Lâmpada Torpedo Média 10W - 12V - Med.: 10X36	 L-6411 Lâmpada Torpedo Grande 10W - 12V - Med.: 11X41	 L-2721 Esmagada Pequena (Pinguinho) 1,2W - 12V	 L-2821 Esmagada Grande (Pingão) 3W - 12V
 L-2825 Esmagada Grande (Pingão) 5W - 12V	 L-2825SW Esmagada Grande 5W - 12V (Pingão) Azul		 L-0922 Super Pingão 15W - 12V
 L-75/75 Assimétrica Farol 75/75W-12V		 L-P40 Pendente 40W - 12V	Lâmpadas Halógenas ➔
 L-H155 H1 55W - 12V	 L-H1100 H1 100W - 12V	 L-H355 H3 55W - 12V	 L-H3100 H3 100W - 12V
 L-H435 H4 35/35W - 12V	 L-H435X H4 35/35W - 12V Super White - Unitário	 L-H455 H4 60/55W - 12V	 L-H4100 H4 100/90W - 12V





Lâmpadas



L-H555
H5 60/55W - 12V



L-H5100
H5 100/90W - 12V



L-H755
H7 55W - 12V



L-H7100
H7 100W - 12V



L-H1155
H11 55W - 12V



L-HB1
HB1 65/45W - 12V - 9004



L-HB1100
HB1 100/80W - 12V - 9004



L-HB3
HB3 65W - 12V - 9005



L-HB4
HB4 55W - 12V - 9006

- Lâmpadas Miniatura, H1 55W, H3 55W, H4 60/55W e H7 55W
Embalagem com 10 peças.



GL2721MF



Lampada de painel / interruptores
1,2W 12V - com **soquete preto**
Marca: Gauss

GL2721MF8



Lampada de painel / interruptores
1,2W 12V - com **soquete preto**
Marca: Gauss

GL64124MF



Lampada de painel / interruptores
5W 12V - com **soquete preto**
Marca: Gauss

GL2721MFx



Lampada de painel / interruptores
1,2W 12V - com **soquete azul**
Marca: Gauss

GL2722MFx



Lampada de painel / interruptores
2W 12V - com **soquete verde**
Marca: Gauss

GL2722MF



Lampada de painel / interruptores
2W 12V - com **soquete verde claro**
Marca: Gauss

GL2452MFx6



Lampada de painel / interruptores
1,5W 12V - com **soquete bege**
Marca: Gauss

GL2473MFx6



Lampada de painel / interruptores
1,1W 12V - com **soquete laranja**
Marca: Gauss

GL1056DC



Lampada 1 polo 21W 12V Pisca
Ambar/Diadem - Blister - Par
Marca: Gauss

GL12495



Lampada 2 polos 21/5W 12V
Cor: **vermelha**
Marca: Gauss

GL7504



Lampada 1 polo 21W 12V Wedge
Cor: **Ambar - linha Honda/Toyota**
Marca: Gauss

GL4540



Lampada Farol 45/40W 12V
aplica veículos antigos
Marca: Gauss

GL78



Lampada H8 35W 12V
Marca: Gauss

GL80



Lampada H9 35W 12V
Marca: Gauss

GL116H16



Lampada H16 19W 12V
Marca: Gauss

GL880



Lampada H27-1 50W 12V
Soquete com encaixe **reto**
Marca: Gauss

GL881



Lampada H27-2 50W 12V
Soquete com encaixe em **L**
Marca: Gauss

GL2827



Lampada Pingão 5W 12V
Cor: **Ambar - emb. 10 pçs**
Marca: Gauss

L-0922A



Lampada Super Pingão 15W 12V
Cor: **Ambar - emb. 10 pçs**
Marca: Importada

L-H1155



Lampada H11 55W 12V
Marca: TechOne

TH21



Lampada 1 polo 21W 12V
Pisca C4 Picasso, C4 VTR, Audi Q7
Marca: Tesla

TH21AB



Lampada 1 polo 21W 12V **Ambar**
Pisca Vectra Novo, linha C3/C4
Marca: Tesla

TH1217



Lampada 1 polo 24W 12V
Pisca Golf 14/ Peug. 208, Fusion, A3/Q3
Marca: Tesla

TH1217A



Lampada 1 polo 24W 12V **Ambar**
Pisca Golf 14/ Peug. 208, Fusion, A3/Q3
Marca: Tesla

Lâmpadas Super White



GL16H5
H5 60/55W - 12V
Super White - Unitário



GL18H5
H5 100/90W - 12V
Super White - Unitário



GL24H11
H11 55W - 12V
Super White - Unitário



GL26H11
H11 100W - 12V
Super White - Unitário



GL28HB1
HB1 65/45W - 12V
Super White - Unitário



GL30HB1
HB1 100/80W - 12V
Super White - Unitário



GL32HB3
HB3 65W - 12V
Super White - Unitário



GL34HB3
HB3 100W - 12V
Super White - Unitário



GL36HB4
HB4 55W - 12V
Super White - Unitário



GL38HB4
HB4 100W - 12V
Super White - Unitário



GL40HB5
HB5 65/55W - 12V
Super White - Unitário



GL42HB5
HB5 100/80W - 12V
Super White - Unitário

Super White
Blister



GL55H1
H1 55W - 12v
Super White - Par



GL56H1
H1 100W - 12v
Super White - Par



GL57H3
H3 55W - 12v
Super White - Par



GL58H3
H3 100W - 12v
Super White - Par



GL59H4
H4 60/55W - 12v
Super White - Par



GL60H4
H4 100/90W - 12v
Super White - Par



GL61H7
H7 55W - 12v
Super White - Par





Lâmpadas Super Brancas



L-H155XP
Lâmpada H1 55W 12V
8500K - Par - Caixa Acrílica



L-H355XP
Lâmpada H3 55W 12V
8500K - Par - Caixa Acrílica



L-H455XP
Lâmpada H4 60/55W 12V
8500K - Par - Caixa Acrílica

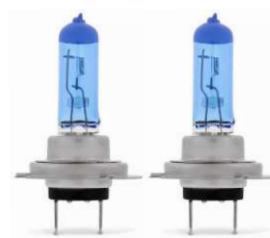

L-H755XP
Lâmpada H7 55W 12V
8500K - Par - Caixa Acrílica



L-H1155XP
Lâmpada H11 55W 12V
8500K - Par - Caixa Acrílica



L-H27-2XP
Lâmpada H27-2 27W 12V (881)
6000K - Par - Caixa Acrílica



L-H1624X
Lâmpada H16 24W 12V
8500K - Unidade - Caixa Ind.



L-H16-2-19X
Lâmpada H16 em L 19W 12V
8500K - Unidade - Caixa Ind.



L-2825/2LEDS
Lâmpada Pingão 2 LEDs
12V - Super Branca - Par



L-2825/12LEDS
Lâmpada Pingão 12 LEDs
12V - Super Branca - Par



L-6411/4LEDS
Lâmpada Torpedo 41mm 4 LEDs
12V - Super Branca - Par



L-6411/6LEDS
Lâmpada Torpedo 41mm 6 LEDs
12V - Super Branca - Par



Z-0145
Relê Duplo de Farol 12V
Saída 2X250W - 2 Fusíveis 30A
Compatível c/ Farol, Limpador e Ignição



Z-2714
Protetor Solar / Tampa Sol p/ Para-brisa
Logo Techone

Lâmpadas em LED

TESLLA QUALIDADE
 HALOGEN SCHEINWERFERLAMPEN **VTO**
 AUTOMOTIVOS



TL2721
 Lâmpada Esmagada Pequena
 (Pinguinho) - 12V
 LED Branco - PAR



TL2821
 Lâmpada Esmagada Grande
 (Pingão) - 12V
 LED Branco - PAR



GL52
 Lâmpada Esmagada Grande
 (Pingão) 12V
 LED Azul - Par
Marca: GAUSS



TL69
 Lâmpada 69 - 12V
 LED Branco - PAR



TL67
 Lâmpada 67 - 12V
 LED Branco - PAR



TL6418
 Lâmpada Torpedo Média
 12V
 LED Branco - PAR



TL6411
 Lâmpada Torpedo Grande
 12V
 LED Branco - PAR



TL1141
 1141 - 1 pólo 21W - 12V
 Pisca ou Ré
 LED Branco - PAR



TL1034
 1034 - 2 pólos 21/5W - 12V
 Lanterna Freio
 LED Branco - PAR



Todas as lâmpadas
 no **Blister**

LED (Light Emitting Diode) Diodo Emissor de Luz

- ↑ Luminosidade
- ↑ Durabilidade
- ↓ Consumo

A Evolução presente no seu carro!



Fusíveis



Fusíveis Lâmina	Código		Aplicação
	H-1003	3	Fusível para proteção do sistema elétrico do veículo (embalagem c/ 10 peças)
	H-1005	5	
	H-1007	7,5	
	H-1010	10	
	H-1015	15	
	H-1020	20	
	H-1025	25	
	H-1030	30	
H-1040	40		

Fusíveis Lâmina Mini	Código		Aplicação
	H-2003	3	Fusível para proteção do sistema elétrico do veículo (embalagem c/ 10 peças)
	H-2005	5	
	H-2007	7,5	
	H-2010	10	
	H-2015	15	
	H-2020	20	
	H-2025	25	
	H-2030	30	

Fusíveis Vidro	Código		Aplicação
	H-9005	5	Fusível para proteção do sistema elétrico do veículo (embalagem c/ 10 peças)
	H-9015	15	
	H-9030	30	
	H-12005	5	Fusível Mini - Vidro 5 (Pequeno para Rádio)

Fusíveis Louça	Código		Aplicação
	H-7015	15	Fusível para proteção do sistema elétrico do veículo (embalagem c/ 10 peças)
	H-7020	20	
	H-7030	30	

Fusíveis Lâmina Maxi	Código		Aplicação
	H-3020	20	Fusível para proteção do sistema elétrico do veículo
	H-3030	30	
	H-3040	40	
	H-3050	50	
	H-3060	60	
	H-3070	70	
	H-3080	80	

Fusíveis Mini Elemento Curto	Código		Aplicação
	H-2105	5	Aplicação Nacionais e Importados Toyota, Honda (embalagem c/ 10 peças)
	H-2107	7,5	
	H-2110	10	
	H-2115	15	
	H-2120	20	
	H-2125	25	
	H-2130	30	

Porta Fusíveis	Código	Aplicação
	HPL-1,5	Porta Fusível Lâmina - Fio Ø 1,5mm (embalagem c/ 10 peças)
	HPL-4,0	Porta Fusível Lâmina - Fio Ø 4,0mm (embalagem c/ 10 peças)
	HPM-4,0	Porta Fusível MAXI - Fio Ø 4,0mm (embalagem c/ 10 peças)
	HPV-1,5	Porta Fusível Vidro - Fio Ø 1,5mm (embalagem c/ 10 peças)

Fusíveis Midi Fêmea Linha HAL 5000	Código		Cor	Aplicação
	HAL-5020	20	Azul	Chrysler, Ford, Honda, Hyundai, Isuzu, Lexus, Mazda, Mitsubishi, Suzuki, Toyota
	HAL-5030	30	Rosa	
	HAL-5040	40	Verde	
	HAL-5050	50	Vermelho	
	HAL-5060	60	Amarelo	
	HAL-5070	70	Marrom	
	HAL-5080	80	Preto	

Fusíveis Midi Linha HAL 5100	Código		Cor	Aplicação
	HAL-5120	20	Azul	Ford, Toyota, Nissan
	HAL-5130	30	Rosa	
	HAL-5140	40	Verde	
	HAL-5150	50	Vermelho	
	HAL-5160	60	Amarelo	

Fusíveis Midi Macho Linha HAL 5200	Código		Cor	Aplicação
	HAL-5230	30	Rosa	Chrysler, Ford, Hyundai, Jeep, Kia, Mitsubishi, Toyota, Mazda, Isuzu, Lexus, Nissan, Suzuki, Subaru, VW
	HAL-5240	40	Verde	
	HAL-5250	50	Vermelho	
	HAL-5260	60	Amarelo	
	HAL-5270	70	Marrom	
	HAL-5280	80	Preto	
	HAL-52100	100	Azul	
	HAL-52120	120	Bege	

Fusíveis Midi Linha HAL 5300	Código		Cor	Aplicação
	HAL-5330	30	Rosa	Chrysler, Ford, Hyundai, Kia, Honda, Mazda, Mitsubishi, Nissan, Suzuki, Subaru, Toyota
	HAL-5340	40	Verde	
	HAL-5350	50	Vermelho	
	HAL-5360	60	Amarelo	
	HAL-5370	70	Marrom	
	HAL-5380	80	Preto	
	HAL-53100	100	Azul	
	HAL-53120	120	Bege	

Fusíveis Midi Linha HAL 5400	Código		Cor	Aplicação
	HAL-5430	30	Rosa	Chrysler, Ford, Hyundai, Kia, Honda, Mazda, Mitsubishi, Nissan, Suzuki, Subaru, Toyota
	HAL-5440	40	Verde	
	HAL-5450	50	Vermelho	
	HAL-5460	60	Amarelo	
	HAL-5470	70	Marrom	
	HAL-5480	80	Preto	
	HAL-54100	100	Azul	
	HAL-54120	120	Bege	

Fusíveis Midi Linha HAL 6000	Código		Cor	Aplicação
	HAL-6020	20	Azul	Ford
	HAL-6030	30	Rosa	
	HAL-6040	40	Verde	
	HAL-6050	50	Vermelho	
	HAL-6060	60	Amarelo	

Fusíveis de Potência/Som



Fusíveis de Potência Midi	Código		Aplicação
	H-7030M	30	Aplicação Eletrônico e Som Utilizado para proteção de módulos e instalação de som, equipamentos e circuitos de alta corrente com voltagem máxima de 32VDC.
	H-70100	100	
	H-70150	150	

Fusíveis de Potência Mega	Código		Aplicação
	H-80100	100	Aplicação Eletrônico e Som Utilizado para proteção de módulos e instalação de som, equipamentos e circuitos de alta corrente com voltagem máxima de 32VDC.
	H-80150	150	
	H-80200	200	

Base para Fusível Potência Midi	Código	Aplicação
	HPMM	Base para Fusível Potência Midi

Base para Fusível Potência Mega	Código	Aplicação
	HPMP	Base para Fusível Potência Mega



Botões, Chaves e Interruptores



 VTO220 - VTO 9151007 - Facobras Chave Tic-Tac 2 posições Cromada	 VTO221 - VTO Chave Tic-Tac 3 posições Cromada	 C-TP - KTR Chave Tic-Tac 2 posições Plástica - Preta	 VTO222 - VTO 9151001 - Facobras Chave Puxada	 C-DKW - DSC Interruptor de Partida Universal “Botão DKW”
 C-BAA Botão Antipânico Emergência Almofadinha Pct c/ 10 unidades	 C-BAQ Botão Antipânico Emergência Quadrado Pct c/ 10 unidades	 C-IR Interruptor Regulável Universal		

Soquete de Lâmpada







 3259 Soquete de Lâmpada 1 pólo Nylon - Tipo Roseta 2 fios	 3260 Soquete de Lâmpada 2 Pólos Nylon - Tipo Roseta 3 fios	 3254 Soquete de Farol Universal Fio 1,5mm	 3262 Soquete de Lâmpada H7 Fio 1,5mm
---	--	--	--

➤ Embalagem com 10 peças



Terminais de Fio



 <p>ETE 7020 Encaixe Fêmea 6,3mm para fio 0,75mm a 2,5mm - sem trava Similar: F1180</p>	 <p>ETE 7020A Encaixe Fêmea 6,3mm para fio 0,75mm a 2,5mm - com trava Similar: F1182</p>	 <p>ETE 7027 Encaixe Fêmea 4,8mm para fio 1,00mm - sem trava</p>	 <p>ETE 7030 Encaixe Fêmea 2,8mm - Mosquitinho para fio 0,75mm a 2,5mm - com trava Similar: F1186</p>
 <p>ETE 7028 Encaixe Macho curto 6,3mm para fio 1,0mm a 2,5mm Similar: F1112</p>	 <p>ETE 7033 Encaixe Macho longo 6,3mm (Espadão) para fio 0,75mm a 2,5mm com trava Similar: F1113</p>	 <p>ETE 7033A Encaixe Macho 2,8mm (Espadinha) para fio 0,3mm a 1,0mm - com trava Similar: F1114</p>	 <p>ETE 7021 Olhal 3/16" para fio 1,5mm Ø int.: 5,4mm Ø ext.: 8mm</p>
 <p>ETE 7022 Olhal 3/16" para fio 2,5mm Ø int.: 5mm Ø ext.: 9,5mm Similar: F1132</p>	 <p>ETE 7023 Olha 1/4" para fio 1,5mm Ø int.: 6,5mm Ø ext.: 11,9mm</p>	 <p>ETE 7023A Olha 1/4" para fio 2,5mm Ø int.: 7,0mm Ø ext.: 12,0mm</p>	 <p>ETE 7031 Olhal 3/8" para fio 10mm Ø int.: 11,0mm Ø ext.: 18,0mm</p>

➤ Preços da embalagem contendo 100 peças.

Alojamentos / Luvas

 <p>ETE 7500 Alojamento p/ terminal fêmea sem trava série 6,3mm Aplica-se ao terminal ETE 7020</p>	 <p>ETE 7500A Alojamento p/ terminal fêmea com trava série 6,3mm Aplica-se ao terminal ETE 7020A</p>	 <p>ETE 7501 Alojamento p/ terminal macho curto série 6,3mm Aplica-se ao terminal ETE 7028</p>
--	--	--

➤ Preços da embalagem contendo 100 peças.



Conectores Diversos

 <p>ETE 7505 Conector fêmea 5 vias - Base para Relê 5 vias Aplica-se ao terminal ETE 7020A</p>	 <p>ETE 7564 Conector fêmea 5 vias - Base para Relê 5 vias Acompanha terminais ETE 7020A</p>	 <p>ETE 7502 Kits Conectores Macho e Fêmea 2 vias Acompanha terminais ETE 7020A e ETE 7033</p>
 <p>ETE 7503 Kits Conectores Macho e Fêmea 3 vias Acompanha terminais ETE 7020A e ETE 7033</p>	 <p>ETE 7504 Kits Conectores Macho e Fêmea 4 vias Acompanha terminais ETE 7020A e ETE 7033</p>	 <p>ETE 7506 Kits Conectores Macho e Fêmea 6 vias Acompanha terminais ETE 7020A e ETE 7033</p>

➤ Preços Unitários.
➤ Embalagem com 10 peças/jogos.



Fios para Som / Parte Elétrica

Código	Material	Bitola	
	F-C2X18	Bicolor Cristal	2x18 - 0,75 mm
	F-C2X16	Bicolor Cristal	2x16 - 1,00 mm
	F-C2X14	Bicolor Cristal	2x14 - 1,50 mm
	F-C0,75	Cabinho Auto	0,75 mm
	F-C1,0	Cabinho Auto 14F/0,20	1,0 mm
	F-C1,5	Cabinho Auto 20F/0,20	1,5 mm
	F-C2,5	Cabinho Auto 30F/0,20	2,5 mm
	F-C4,0	Cabinho Auto 38F/0,25	4,0 mm
	F-C6,0	Cabinho Auto	6,0 mm

- Disponíveis nas cores preto/vermelho - Especificá-las após o código.
- Todos em rolos com 100 metros.

Fita Isolante



FI-5M
Fita Isolante Anti-chama
Rolo com **5 metros**
Embalagem com 10 rolos

VTO
AUTOMOTIVAS



FI-10M
Fita Isolante Anti-chama
Rolo com **10 metros**
Embalagem com 10 rolos



Espaguete Termo Retrátil



Código	Descrição
GR824	Espaguete Termo-Retrátil 3/32" - 2,4mm
GR818	Espaguete Termo-Retrátil 1/8" - 3,2mm
GR845	Espaguete Termo-Retrátil 3/16" - 4,5mm
GR814	Espaguete Termo-Retrátil 1/4" - 6,4mm
GR875	Espaguete Termo-Retrátil 5/16" - 7,5mm
GR838	Espaguete Termo-Retrátil 3/8" - 9,5mm

- Todas em embalagens com 1 metro.



ESPAGUETE CORRUGADO ARTICULÁVEL

A MAIS COMPLETA LINHA DE TUBOS, CONEXÕES E ACESSÓRIOS PARA CORRUGADOS

Espaguete corrugado **AUTO EXTINGUÍVEL (ANTI-CHAMA)** com corte, na qual facilita a introdução do chicote, fios e cabos em geral.

Faixa de Trabalho: -20°C até 135°C

Código	Bitola \varnothing		Embalagem
	Pol.	mm.	
GC 945	3/16"	4.5mm	25 Metros
GC 975	5/16"	7.5mm	25 Metros
GC 938	3/8"	9.5mm	25 Metros
GC 912	1/2"	12.7mm	25 Metros
GC 958	5/8"	15.8mm	25 Metros
GC 934	3/4"	19mm	25 Metros
GC 910	1/1"	25mm	25 Metros



Cor
■

Composição: 100% P.P. (Polipropileno)

Cabos Negativo / Cordoalhas



HC-1015
Monza - Todos

Comprimento: 15 cm



HC-1030
Volks Sedan, Kombi 68/72
Variant I, TL .../70

Comprimento: 30 cm



HC-1040
Universal Volks, Brasília

Comprimento: 40 cm



HC-2050
Santana, Parati, Voyage, Apollo,
Gol e Passatt todos os anos

Comprimento: 50 cm



HC-2152
Santana, Parati, Voyage, Apollo, Gol e
Passatt todos os anos

Comprimento: 50 cm



HC-3030
Universal

Comprimento: 30 cm

Cabos Positivo



HCA-1050
Opala

Comprimento: 50 cm

HCA-1070
Corcel e Belina 69/77
Opala, Caravan,
Comodoro 80/...
Chevette 73/...
Maverick Todos

Comprimento: 70 cm

HCA-1080
Variant II, TL 72/...
Passat Todos
Kombi 68/75
Monza 82/...

Comprimento: 80 cm

HCA-1100
Gol, Saveiro, Parati,
Santana, Voyage
Agrale 1800D Todos

Comprimento: 100 cm

HCA-54120
Gol, Voyage, Parati
Monza
c/ Duplo Aterramento
Rabicho

Comprimento: 120 cm

Terminais de Bateria



EDL 3034
Terminal de Bateria
Pequeno Sapinho
Negativo

Similar: EDL 3013



EDL 3013
Terminal de Bateria
Pequeno Sapinho
Reforçado
Positivo

Similar: EDL 3034



EDL 3014
Terminal de Bateria
Médio Sapão

Similar: EDL 3020



EDL 3015
Terminal de Bateria
Grande Sapão Extra

Ponteiras de Bateria



EDL 3012
Ponteira Negativa Pequena
para cabos Ø 10mm



EDL 3010
Ponteira Negativa Grande
para cabos Ø 16mm





Buzinas

GAUSS

VTO

AUTOMOTIVOS



B-DL1298H - CAB
Buzina tipo Paquerinha
Importada
Individual - Cor: Preta - 12V



GB1060 - GAUSS
VTO135 - VTO
Buzina tipo Paquerinha
Dupla - Cor: Preta - 12V



VTO125 - VTO
Buzina para Moto
Ø 71mm - 12V



VTO113 - VTO
Buzina Bi-Bi Grande para Caminhão
Ø 123mm - 24V



VTO211 - VTO
Buzina Caracol tipo Mini Fiamm
Individual - **1 Terminal**
Cor: Preta - 12V



GB1052 - GAUSS
VTO213 - VTO
Buzina Caracol tipo Mini Fiamm
Individual - **2 Terminais**
Cor: Preta - 12V



GB1053 - GAUSS
VTO212 - VTO
Buzina Caracol tipo Mini Fiamm
Dupla - **1 Terminal**
Cor: Preta - 12V



GB1054 - GAUSS
VTO215 - VTO
Buzina Caracol tipo Mini Fiamm
Dupla - **2 Terminais**
Cor: Preta - 12V



GB1057 - GAUSS
VTO210 - VTO
Buzina Caracol c/ plug
Linha VW
Individual - 12V - Cor: Preta



GB1051 - GAUSS
VTO214 - VTO
Buzina Caracol c/ plug - **Linha GM 95/...**
Individual - 12V - Cor: Preta



GB1055 - GAUSS
VTO209 - VTO
Buzina Caracol c/ plug
Linha Fiat
Individual - 12V - Cor: Preta



VTO216 - VTO
Buzina Caracol c/ plug
Linha Renault
Individual - 12V - Cor: Preta



VTO217 - VTO
Buzina Caracol c/ plug
Linha Peugeot
Individual - 12V - Cor: Preta

Buzinas a Ar



VTO042 - VTO
Buzina a Ar 2 Cornetas Compl.
Comp, Rele, Mangueira, Plugs...
Cor: Vermelha - 12V



VTO064 - VTO
Buzina a Ar 3 Cornetas Compl.
Comp, Rele, Mangueira, Plugs...
Cor: Vermelha - 12V



VTO301P - VTO
Buzina a Ar Marítima Corneta
Comp, Rele, Mangueira, Plugs...
Cor: Preta - 12V



VTO301C - VTO
Buzina a Ar Marítima Corneta
Comp, Rele, Mangueira, Plugs...
Cor: Cromada - 12V



Reguladores de Voltagem

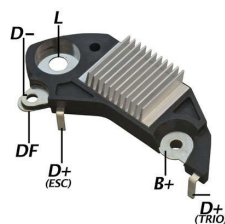

VTO
AUTOMOTIVOS

DE701

Delco - 14V, Campo positivo

Substitui:

Delco: 10475019, 10479914, 10479923, 10479947, 10479955, 1204270, 19009701, **GM:**

140475019, **Opel:** 1204270, DE 701, DE 708

Aplicação:

GM: Omega, Corsa Wind, Vectra após 95, Astra, Frontera, Tigra.

Alternador:

DELCO: Series IR, IF, 10479914, 10479923, 10479947, 10479955, QY6J5, 3493814, 3493823, 3493847, 3493855, 6204002, 6204006, 6204007, 6204008

Módulos de Ignição / Hey



E-KLASS
MOBILETRON

EIG005 - E-Klass

IGH005H - Mobiletron

Todos Motor AP Gol, Santana, Escort, Verona, Versailles Audi, Ford, Nissan, Seat

Similar: Bosch: 0.227.100.142/143/147 BM 342



GAUSS

GA2049

Logus, Pointer, Polo, Apollo, Verona, Escort, Audi 80 - **3 pinos**

Similar: EIG012 1.227030.030 VW 867.905.352



E-KLASS

EIG006 - sem chicote (plug 3 vias) = foto

EIG006T - com chicote (plug 2 vias + terra)
Fiat Uno Mille, Premio, Elba 1.5

Similar: 9.220.087.026 VW 867.905.352



E-KLASS

EIG013

VW Gol 1000, Voyage, Apollo, Passat, Ford Escort CHT 1.6

Similar: 1.227.030.049



E-KLASS

EIG1912

GM Corsa

Similar: 90.243.618



GAUSS

GA2379

Ipanema, Kadett, Monza 92/96

Similar: 1.989.747 16.139.379 D1960A



Relés





RA 1412S
Relé Auxiliar 4 terminais - Buzina
40A - 12V
VW, Ford, GM, Fiat - Universal



TRA 813512
Relé Duplo de Farol
2 X 250W - 12V
Fusíveis Externos
Tamanho reduzido(compacta), com parafuso

Interruptores Térmicos do Radiador (Cebolão)



Código	N° Original	Modelo / Ano	Características	Equivalência
 405-92	ZBA.959.481 81NU-14806-A	Gol, Parati, Saveiro, Logus, Pointer, Voyage, Passat - Todos .../93 sem Ar Corcel e Belina Todos	92° / 87° C M 22 x 1,5	MTE 705 Wahler 6010.92
 405-87	Opcional 81NU-14806-A	Gol, Parati, Saveiro, Logus, Pointer, Voyage, Passat - Todos .../93 Corcel e Belina Todos	86° / 76° C M 22 x 1,5	MTE 705 Wahler 6010.86

Sensor Temperatura Água



55214054 - Magneti Marelli
S-TF - Paralelo

Sensor Temperatura Água Completo (com flange)
FIAT: Fiorino, Palio, Siena, Strada, Uno 1.3 MPI Fire 8V 03/
Idea, Palio, Siena, Strada 1.4 MPI Fire Flex 8V 06/
Palio, Siena 1.3 MPI Fire 16V 05/, 1.3 MPI Fire Flex 8V 04/05
Palio, Siena, Uno 1.0 MPI Fire 8V 01/, 1.0 MPI Fire Flex 8V 06/

Conector: Verde

N° Original: 46.824.133 71716685 / 71719393

Similar: MTE 4099



Bobinas de Ignição

autostar



EURO
INJEÇÃO E IGNIÇÃO



E-KLASS

GAUSS

IgniFort

Zapos



Volkswagem



Audi



30513 - Euro
IG30513 - Ignifort
EBI2027M - E-Klass
Audi 80, Golf 94/98 1.8, Polo Classic
Cordoba - 3 Pinos
N° Original: 6NO905104



Com módulo: 30520 - Euro
Sem módulo: AS-300S - VTO
Logus, Pointer, Apollo - 6 Pinos
N° Original: 547.905.104



30520C - Euro
IG30520C - Ignifort
Logus, Pointer, Apollo - c/ Chicote - 6 Pinos
N° Original: 547.905.104B



IG30529 - Ignifort
Santana 2.0 EF, Versailles 2.0 Todos
Similar Euro: 30529
N° Original: E1EF12029AA



032905106-D - VW/Bosch
30514 - Euro
EBI8030M - E-Klass
VW: Gol/GV/Power, Fox, Parati 1.0 16V,
Golf, Polo Hatch/Sedan 1.6/2.0 8V
Audi: A3 1.6 e 1.8
N° Original: 021.905.106



06A905097 - Importada
Gol, Voyage, Saveiro GV 08/...
Bora - 6 Pinos
Similar Euro: 30576
N° Original: 06A905104/06A905097



Fiat



30546 - Euro
VCH214 - Injetion
Palio/Weekend 1.0/1.3 MPI 16V Fire
1.0i/1.3i 00/... Siena 1.3/1.3i 16V Fire
N° Original: 46752948/ F000ZS0206



30522 - Euro
IG30522 - Ignifort
Fiat: Uno, Palio, Siena 1.0, 1.5, 1.6
Premio, Elba 1.5 e 1.6, Tempra 2.0 8V/16V
N° Original: 7.626.232



30521 - Euro
ABI03002 - Autostar
Fiat Tipo 1.6 8V, Uno 1.6 MPI 08/94
N° Original: 7.648.797
N° Bosch: 0 221 503 407



EBI 8015 - Sist. M. Marelli - E-Klass
EBI 8033 - Sist. Champion - E-Klass
30547 - Euro
IG30547 - Ignifort
Palio, Brava, Marea 1.6 16V
N° Original: 46472440/ BAE920A



Bobinas de Ignição

autostar



EURO
INJEÇÃO E IGNIÇÃO



E-KLASS

GAUSS

IgniFort

Zapos



30539 - Euro
ABI03003 - Autostar
Uno IE 89/... Tempra 90/...
N° Original: 7582152/ 7663177



EBI 8060 - E-Klass
ABI02005 - Autostar
Stilo 1.8 16V
Similar Euro: 30548
N° Original: 1208307/ 9005212



ABI02006 - Autostar
Blazer, S10 4.3
Similar Euro: 30563
N° Original: 10.489.421



ABI02008 - Autostar
Astra, Meriva, Zafira, Vectra 1.8 16V
Similar Euro: 30575
N° Original: 90.536.194



4 Pinos

30512 - Euro
IG30512 - Ignifort
EBI8004 - E-Klass
ABI02002 - Autostar
IGN115 - Zapos
Corsa 1.0/1.4/1.6 - 8V/16V - 4 Pinos
N° Original: 1.104.038



3 Pinos

30527 - Euro
IG30527 - Ignifort
Celta, Corsa Novo, Montana, Meriva
Todos Motor 8v - 3 pinos
N° Original: 93.363.483

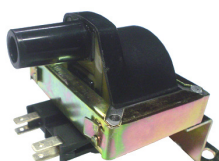

30578 - Euro
Corsa 1.0/1.4 EFI
Astra 1.4/1.6/1.8 93/98
N° Original: 93.230.799



EBI 3201A - E-Klass
Ipanema 1.8, 2.0 EFI Gasolina 03/91-92/97
Kadett 1.8, 2.0 EFI Alc./Gas 03/91 - 12/97
Monza 1.8, 2.0 EFI Alc./Gas 03/91 - 12/95
Similar Euro: 30561
N° Original: 9220081502, 9220081509
93230798, D535, D537

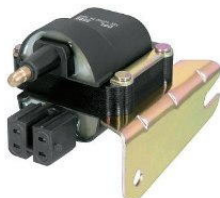

EBI 3203B - E-Klass
C3807A - Zapos
Monza, Kadett 1.8/2.0 EFI 91/96
Injeção Eletrônica
N° Original: 93.230.798



EBI8002A - E-Klass
Astra, Vectra, Zafira 2.0 16V - 3 Pinos
Similar Euro: 30545
N° Original: 93.248.876



EBI 8060 - E-Klass
ABI02005 - Autostar
Meriva, Safira 2.0 16V
Similar Euro: 30548
N° Original: 1208307/ 9005212



Bobinas de Ignição

autostar



EURO
INJEÇÃO E IGNIÇÃO



E-KLASS

GAUSS

IgniFort

ZapOS



30535 - Euro
EBI 8040A - E-Klass
ABI02007 - Autostar
 Astra 1.8, Omega 2.0, Vectra 2.0 16V,
 Calibra 2.0 16V
Nº Original: 90458250

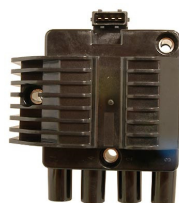

30515 - Euro
IG30515 - Ignifort
EBI8050 - E-Klass
 Corsa 1.0, 1.4 e 1.6.../98
 S10, Blazer, Omega 2.2 95/98
Nº Original: 1.103.923/1103905



VCH230 - Injection
 Astra 1.8/2.0 8V, Vectra 2.0 8V .../99
OBS: Bobina Similar do Tipo 1.6
(30521 - Euro - mudando somente a
ordem dos pinos e sua altura)



Ford



Com módulo: 30520 - Euro
Sem módulo: AS-300S - VTO
 Escort, Verona - 6 Pinos
Nº Original: 547.905.104



30520C - Euro
IG30520C - Ignifort
 Escort, Verona - c/ Chicote - 6 Pinos
Nº Original: 547.905.104B



CM5G-12029-FA - Motorcraft
 Fiesta 02/... Ka, Courier, Ecosport, Mondeo
Similar Euro: 30552
Similar Bosch: 020221503485



30516 - Euro
ABI06002 - Autostar
CHB 6019 - CTP
 Fiesta 1.6, Novo Fiesta, Ka 1.6,
 Focus 1.8, 2.0 Ecosport 1.0, 1.6 Escort, Mondeo 1.8,
 2.0, Courier 1.6 - Motor Zetec Rocan
Nº Original: A988F-12024-AC/ BI0020MM



30517 - Euro
ABI06001 - Autostar
 Fiesta, Ka, Escort, Courier, Endura 1.0/1.3
 Zetec 1.4/1.8 16V
Nº Original: 88SF-12029-A2A



IG30529 - Ignifort
 Versailles 2.0 Todos, Santana 2.0 EF
Similar Euro: 30529
Nº Original: E1EF12029AA



Citroën



30609 - Euro
 Picasso, C4, C5, 307 2.0 16V
Nº Original: 5970.75/96632641



Bobinas de Ignição

autostar

BOUGICORD

EURO
INJEÇÃO E IGNIÇÃO



E-KLASS

GAUSS

IgniFort

Zapos



Honda



30610 - Euro
Fit 1.4 8v - Parte Dianteira do Motor
N° Original: CM11108/ BI0028MM



30611 - Euro
Fit 1.4 8v - Parte Traseira do Motor
N° Original: CM11109/ BI0027MM



EBI 3403 - E-Klass
ABI07001 - Autostar
Civic 1.6i 16v 94/00, Accord 2.2/2.3 16V
Similar Euro: 30510
N° Original: 30510P73A01-2/PT2-006



Peugeot



Renault



7700875000 - Renault/BERU
30523 - Euro
IG30523 - IGNIFORT
Renault Clio, Megane, Scenic 1.6 16V
N° Original: 7626232



30530 - Euro
Peugeot 206/306 1.6 16V 00/...
N° Original: 597080/ 096363378



30531 - Euro
Scenic, Megane, Laguna 1.6 - 16V
N° Original: 7700100589



30544 - Euro
ABI05004 - Autostar
Renault Scenic, Megane 1.8 - 2.0 8V
N° Original: 77001072269



30551 - Euro
Renault Clio 1.0 98/... Kangoo,
Twingo 1.2 96/98, Megane 1.6
Scenic 1.6 99/... - Conector Oval
N° Original: 7700274008



ABI05005 - Autostar
Renault Clio 1.2/1.4 Kangoo 1.2/1.6
Megane 1.6, Twingo 1.2
N° Original: 770010269



EBI 8051 - E-Klass
ABI04001 - Autostar
Peugeot 206 1.4/1.6 8/16V
Gasolina - Conector Preto
N° Original: 597072/74



EBI 8051A - E-Klass
Peugeot 206 1.4 16V 00/...
Flex - Conector Cinza
N° Original: 597079



Gasolina

151401 - Bougicord
30518C - Euro
IG30518 - Ignifort
YMAX4401 - Ymax
ABI05001 - Autostar
Peugeot 1.0 16V Todos - Gasolina
Renault 1.0 16V Todos - Gasolina
N° Original: 8200084401



Flex

151405 - Bougicord
IG30518A - Ignifort
YMAX4402 - Ymax
CHB208-F - CTP
Peugeot 1.0 16V Todos - Flex
Renault 1.0 16V Todos - Flex
N° Original: 8200084401/ BI0026MM



Bobinas de Ignição

autostar

BOUGICORD

EURO
INJEÇÃO E IGNIÇÃO



E-KLASS

GAUSS

IgniFort

ZapOS



Toyota

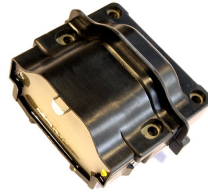

30543 - Euro

Toyota Corolla 95/97, Camry 92/95

N° Original: 90919-02163/ 948555502

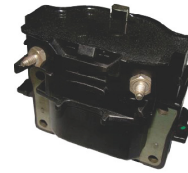

ABI08001 - Austostar

Toyota Corolla 1.6 16V 92/02

N° Original: ----





Bobinas a Óleo



Código	Descrição
IG40098	VW: Gol, Quantum, Santana (c/ Pino)
IG40097	FORD: Escort, Hobby, Pampa, Royale, Versailles VW: Gol, Fusca, Kombi, Parati, Saveiro, Voyage, Quantum (c/ Pino)
IG40091	FIAT: Elba, Fiorino, Furgão, Pick-Up, Prêmio, Tempira, Uno, Mille GM: Chevett, Chevy 500, Kadett, Marajó, Monza
IG40077	FORD: Royale, Versailles VW: Gol, Parati, Santana, Quantum, Saveiro, Voyage (c/ Pino)
IG40067	GM: Monza, Opala, Caravan, Chevett Hatch, Chevy 500, Ipanema, Kadett, Marajó VW: Gol, Parati, Fusca, Santana, Quantum, Saveiro, Voyage, Passat, Apollo, Kombi FIAT: 147, Oggi, Panorama, Spazio FORD: Belina II, Corcel II, Del Rey, Escort, Pampa, Verona, Royale, Versailles, F1000
IG40054	VW: Fusca, Puma, Voyage, Variant, Passat, K. Ghia, Kombi FIAT: Elba, Premio, Uno, Fiorino, 147, Oggi, Panorama, Spazio FORD: Belina I/II, Corcel I/II
IG40039	VW: Fusca, Kombi, Saveiro, Brasília





CÓDIGO	DESCRIÇÃO DO PRODUTO	MARCA
RT0215	ROTOR DISTR VW,FIAT,FORD,GM	OLIMPIC
RT0216	ROTOR DISTR MONZA,KADETT .../91	OLIMPIC
RT0271	ROTOR DISTR GOL,FORD,FIAT 147	OLIMPIC
RT0273	ROTOR DISTR MONZA MPFI, KADETT GSI	OLIMPIC
RT0300	ROTOR DISTR VW,FORD	OLIMPIC
RT0560	ROTOR DISTR MONZA/KADETT EFI 91/96	OLIMPIC
RT0561	ROTOR DISTR CORSA 1.0 94/96 SIST.LUCAS	OLIMPIC
RT0562	ROTOR DISTR TEMPRA 16V 93/94 - BRANCO	OLIMPIC
RT0628	ROTOR DISTR VW,GM,FORD,FIAT,CHRYSLER	OLIMPIC
RT0677	ROTOR DISTR GOL 1.0 MI,CORSA 1.0/1.4 EFI SIST.BOSCH	OLIMPIC
RT0712	ROTOR DISTR FUSCA,BRASILIA,PARATI,VOYAGE	OLIMPIC
MQ0563	ROTOR DISTR ASTRA,VECTRA,OMEGA 2.0/2.2	MULTIQUALITA
MQ0562	ROTOR DISTR S10,BLAZER V6	MULTIQUALITA
MQ0561	ROTOR DISTR OMEGA 3.0 6 CIL.	MULTIQUALITA

CÓDIGO	DESCRIÇÃO DO PRODUTO	MARCA
CV-001	CARVAO COM MOLLA DISTR.BOSCH 4,8MM	OLIMPIC
CV-002	CARVAO COM MOLLA DISTR.WAPSA 6,38MM	OLIMPIC
TT0008	TAMPA DISTR FORD,RENAULT,CHRYSLER	OLIMPC
TT0027	TAMPA DISTR SEDAN 1.3 VARIANT	OLIMPIC
TT0056	TAMPA DISTR VW TDS .../86 FIAT FORD,GM	OLIMPIC
TT0196	TAMPA DISTR MONZA,KADETT,IPANEMA TDS /91	OLIMPIC
TT0259	TAMPA DISTR TEMPRA 2.0 CARBURADO,GOL AR	OLIMPIC
TT0320	TAMPA DISTR CHEVETTE 1.4 GAS .../76	TECAB
TT0370	TAMPA DISTR VW,FORD TDS 86/...	OLIMPIC
TT0413	TAMPA DISTR VW TDS .../74 FORD CORCEL	OLIMPIC
TT0442	TAMPA DISTR VW,FORD TDS .../92	OLIMPIC
TT0510	TAMPA DISTR MONZA,KADETT EFI 92/94-OLIMPIC	OLIMPIC
TT0511	TAMPA DISTR CORSA SIST.LUCAS 1.0/1.4 EFI 1.6 94/96	OLIMPIC
TT0512	TAMPA DISTR TEMPRA 16V 93/94 MARELLI,TRAFIC 94/	OLIMPIC
TT0623	TAMPA DISTR CORSA SIST.BOSCH 1.0/1.4 EFI 1.6 94/96	OLIMPIC
MQ0078	TAMPA DISTR S10,BLAZER V6	MULTIQUALITA
MQ0077	TAMPA DISTR OMEGA,VECTRA 4CC .../97	MULTIQUALITA
YMAX-0678A	TAMPA DISTR MONZA,KADETT EFI 92/94-YMAX	YMAX
90369031	TAMPA DISTR OMEGA 3.0 6CC (MQ0079)	MULTIQUALITA



Rotor do Distribuidor



RT 0215 - Tecab
N° Original: 1.234.332.215



Volkswagen

Gol, Parati, Voyage, Saveiro
Passat, Santana, Quantum
Sedan, Brasília, Kombi, Pick-Up - Todos



Fiat

Uno, Fiorino, Prêmio, Elba
Fiat 147, Panorama, Oggi, Spazio - Todos



GM

Chevette, Marajó, Chevy, C-10, Caravan-Tds



Ford

Corcel, Belina, Pampa, Del Rey, Scala
Escort, Verona, F-100, F-1000 - Todos

Todos com Ignição Eletrônica



RT 0216 - Tecab
N° Original: 1.234.332.216



GM

Monza, Kadett, Ipanema - Todos 91
(Bosch-Transistorizado-Ign. Eletr.)



RT 0300 - Tecab
N° Original: 1.234.332.300



Volkswagen

Gol 1.0 AE, Gol, Voyage, Parati e
Saveiro 1.6AE 1.8AP
Santana 1.8 e 2.0 - Ignição TZ/H 92/...



Ford

Escort 1.6, Pampa 1.8 e 2.0
(Bosch/Transis./Ign.Eletr.)



RT 0628 - Tecab
N° Original: 9.231.081.628



Volkswagen

A ar 74/... (Bosch/Platinado)



Fiat

Uno S, CS 1.3 .../88, Elba S 1.3, Prêmio 1.3, Fiat 147, Fiorino, Panorama (gas./álc.)
.../04.83, Oggi .../85, Spazio .../84



GM

Chevette 1.4 (gas./álc.) .../08/82, Chevette 1.6 ...C Chevy .../83, Marajó 1.6
(gas./álc.) .../08/82



Ford

Belina e Corcel 1.4 .../77,
Belina II e Corcel II 1.4, 1.6 .../06/83
F-100, Maverick, Utilitários Todos



Chrysler

Dodge 1800, Polara ... /03/78

Todos com Ignição Eletrônica

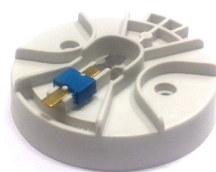

KNR-012 - Ymax
N° Original: 10452457



GM

Blazer, S10 4.3 V6



90540398 - Ymax
N° Original: 90540398



GM

Astra, Vectra 94/96, Omega 2.0/2.2



KNR-090 - Ymax
N° Original: 12 12 220



GM

Omega 3.0 6 cil.



Tampa do Distribuidor



TT 0027 - Tecab
Similar Bosch: 1.235.522.027



Volkswagen

Sedan 1.3 .../11/74, 1.5 .../09/72, Variant
 TL K. Ghia 1.5 - 1.6 - /03-72
 Bosch - c/ Platinado Distr. Baixo



TT 0196 - Tecab
Similar Bosch: 1.235.522.196



GM

Monza, Kadett, Ipanema - Todos .../91
 (Bosch-Transist.c/ Ignição.Eletronica)



T606 - Tecab
Similar Original: 1.925.606



GM

Opala, Caravan 69/83
 Pick-up, Caminhoneta 4 cil.
 (gas./álc.) - Todos
 Marca: **Flexocabos**



TT0320 - Tecab
Similar Original: 9.231.081.320



GM

Chevette 1.4 .../76 (gas.)



TT 0413 - Tecab
Similar Bosch: 9.231.081.413



Volkswagen

Brasília 1600(Carb.Dup e Simp.) (gas.)
 03-74/ 12-82
 Sedan 1600 (Carb.Dup e Simp.) (gas.)
 05-74/76
 K. Guia TC 02/74 / 75
 Kombi 1500 05/74 / 75
 Kombi 1600 (gas.) .../83
 Sedan 1300 (gas.) 02/74 / 85
 Sedan 1500 (gas.) 05/74 / 83



Ford

Belina,Corcel 1.4 (gas.) .../77
 Belina II,Corcel II 1.4, 1.6 (gas.) .../06/83
 F-100 (gas.) .../86
 Maverick (4 cil.) .../06/83



Chrysler

Dodge 1800 e Polara ... /03/78



TT 0442 - Tecab
Similar Bosch: 9.232.081.442



Volkswagen

Gol 1000 (AE 1000 gas.)
 Gol,Voyage,Parati,Saveiro
 (AE 1600 AP 1800)
 Santana,Quantum 1.8 2.0 (gas./álc.)
 Todos com Ignição TZ / H 92/...



Ford

Escort,Verona 1.6 (álc./gas.)
 Pampa,Versailles 1.8 (álc./gas.)
 Versailles 2.0 (álc./gas.)



TT 0370 - Tecab
Similar Bosch: 1.235.522.370



Volkswagen

Brasília 1300 (álc.) .../12/81
 Gol 1.6 C, CL, GL AP 1600 (álc.) 09/84 / 89
 Gol 1.6 C, CL, BL AE 1600 (gas./álc.) 90/...
 Gol 1.6 C, CL, GL AP (gas.) 09/84 / 07/85
 Gol 1.8 GT (gas./álc.) .../07/86
 Kombi Pick-Up 1600 (gas./álc) Todos
 Parati 1.5 (gas./álc.) .../04/82
 Parati 1.6 C, CL, GL AP 1600 (álc.) .../02/86
 Parati 1.6 C, CL, GL AE 1600 (gas./álc) 90/...
 Parati 1.6 C, CL, GL AP 1600 (gas.) .../07/85
 Passat 1.5 (gas./álc.) .../07/82
 Passat 1.6 (gas./álc.) .../09/85
 Passat 1.8 GTS, Pointer (álc.) .../03/86
 Quantum, Santana 1.8 CL, GL, GLS .../03/86
 Saveiro 1.6 C, CL, GL AP 1600 (álc.) 09/84 / 02/86
 Saveiro 1.6 C, CL, GL AP 1600 (gas.) 09/84 / 07/85
 Saveiro 1.6 C, CL, GL AE 1600 (gas./álc.) 90/...
 Sedan 1600 (gas./álc.) .../86
 Voyage 1.5 (gas./álc.) .../04/82
 Voyage 1.6 C, CL, GL, AP 1600 (gas./álc.) .../02/86
 Voyage 1.6 C, CL, GL AE 1600 (gas./álc.) 90/...
 Voyage 1.6 C, CL, GL AP 1600 (GAS.) .../07/85



GM

Opala, Caravan (4 cil.) (gas./álc.) Todos
 Chevette, Marajó 1.4 (gas./álc.) .../08/87
 Chevette, Marajó 1.6 (gas./álc.) Todos
 Chevy 500 (gas./álc.) Todos



Fiat

Alfa Romeo 2300 TI (gas./álc.) .../86
 Elba S 1.3 (álc.) .../88
 Elba S 1.3 (gas./álc.) 89/...
 Elba CS 1.5 (álc.) 89/...
 Elba CS 1.5 (álc.) .../88
 Fiat 147 Fiorino Panorama (álc.) .../86
 Oggi (álc.) .../85
 Prêmio S 1.3 (álc.) .../88
 Prêmio S 1.3 (gas./álc.)89/...
 Prêmio CS 1.5 (álc.) 89/...
 Spazio (álc.) .../84
 Uno S, CS 1.3 (álc.) .../88
 Uno S, CS 1.3 (gas./álc.) .../89
 Uno SX 1.5 (álc.) .../86



Ford

Belina, Corcel II 1.6 (gas./álc.)
 .../06/83
 Belina II 1.6 CHT (gas.) 07/83 / 89
 Corcel II 1.6 CHT (gas./álc.) 07/83 /
 86
 Del Rey, Pampa 1.6 (gas./álc.)
 .../06/83
 Del Rey,Pampa 1.6 CHT (gas./álc.)
 07/83 / 89
 Escort 1.3 (gas./álc.) .../85
 Escort 1.6 (gas./álc) Todos
 F-100 (4 cil.) (Georgia) (gas./álc.)
 .../86
 Scala 1.6 CHT (gas./álc.) .../86
 Verona 1.6 (gas./álc.) .../86
 Todos com Ignição Eletrônica



Tampa do Distribuidor



TT 0056 - Tecab
Similar Bosch: 1.235.522.056



Volkswagen

Santana 1.8 86/...
Santana 2.0 89/...
Quantum 1.8 90/...
Quantum 2.0 89/...
Saveiro 1.6 AP 1600 85/89
Saveiro 1.8 89/...
Voyage 1.6 AP 1600 85/89
Voyage 1.8 89/...
Pointer .../03/89
Village /03.89
Passat 1.6 85/89
Gol 1.6 AP 1600 85/89
Gol 1.8 .../90
Parati 1.6 AP 1600 85/89



Ford

Escort 1.8 XR3 (gas./álc.)
Escort Guia 1.8 (gas./álc.)
Escort 1.8 Guarujá (gas.)
Belina 1.8 (gas./álc.)
Del Rey 1.8 (gas./álc.)
Pampa 1.8 (gas./álc.)
Verona 1.8 (gas./álc.)
Versailles 1.8 (gas./álc.)
Versailles 2.0 (gas./álc.)



X90376981 - Ymax
N° Original: X90376981



GM

Astra, Vectra 94/96, Omega 2.0/2.2



90369031 - Ymax
N° Original: 90369031



GM

Omega 3.0 6 cil.



X10457458 - Ymax
N° Original: X10457458







GM

Blazer , S10 4.3 V6



Distribuidor Completo - Importado

 <p>Volkswagen Ford</p>	 <p>043905205N Fusca, Kombi Sem Avanço IGNIÇÃO 1600 06/82...</p>	 <p>043905205M Fusca, Kombi Com Avanço 1300 12-74/05-91</p>
 <p>YMAX018 Fusca Sistema Aranha Com Chicote e Avanço</p>	 <p>50002 Gol, Parati, Santana, Apolo, Verona Com Avanço</p>	 <p>YMAX003 Gol, Parati, Santana, Apolo, Verona Sem Avanço</p>
 <p>9230087244 Gol Mi Novo AT 8V/16V - 1.0 N° VW: 030905215.1 - Bosch: 9230087244</p>	 <p>GM</p>	 <p>7049 Opala 6 CC Com Avanço</p>
 <p>7050 Opala 4 CC Com Avanço</p>	 <p>50003 Corsa 1.0/1.4 EFI 94/...</p>	 <p>YMAX006 S10, Blazer - Motor V6</p>
 <p>MQ0509 Monza, Kadett, Ipanema, Ipanema, S10 91/97 Todos 1.8/2.0 EFI</p>		



K820



DSC1702



DSC1709



K65431



« PROMOÇÃO »

BOMBA PARTIDA A FRIO UNIVERSAL
SIMILAR: BF12 / VP-7018

GUARNICAO BOMBA INJETORA PART
A FRIO - UNIVERSAL

GUARNICAO RESERVATÓRIO PARTIDA
FOX, POLO, GOL

RESERVATORIO LAVADOR
PARA BRISA GOL 96/... - DK65431



JSW0101



VALVULA SOLENOIDE 2 VIAS
CONEC. UNIVERSAL - DS 2002

JSW0102



VALVULA SOLENOIDE 3 VIAS
CONEC. UNIVERSAL - DS 2003

JSW0103



VALVULA SOLENOIDE 2 VIAS 50006475
MILLE / FIORINO / MONZA 87/91-DS 2005

JSW0104



VALVULA SOLENOIDE 2 VIAS
CONEC. GM - DS 2001

JSW0105



VALVULA SOLENOIDE 2 VIAS
CITROEN C3 / X SARA / C4 - DS 2007

JSW0106



VALVULA SOLENOIDE 3 VIAS 50006476
FIAT UNO MILLE / FIORINO SPI

JSW0107

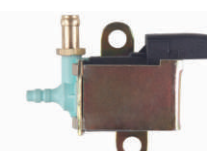

VALVULA SOLENOIDE 2 VIAS 52260420
GM MONZA / KADETT / IPANEMA EFI

JSW0108



VALVULA SOLENOIDE 2 VIAS CLIO/LOGAN
SANDERO/MEGANE/SCENIC - DS 2011

JSW0109

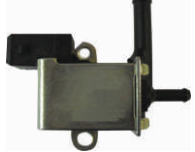

VALVULA SOLENOIDE 2 VIAS
FIAT TODOS 2009/... - DS 2009

JSW0110



VALVULA SOLENOIDE 3 VIAS
VW GOL G5 / FOX / CROSSFOX - DS 2006



RH009

100% EM ALUMÍNIO



CARÇAÇA DA BOMBA DA ÁGUA
MOTORES AP

RH 017

100% EM ALUMÍNIO



CARÇAÇA VÁLVULA TERMOSTÁTICA
UNO 78/02 - KIT

RH 023

100% EM ALUMÍNIO



CARÇAÇA VÁLVULA TERMOSTÁTICA
FIESTA, KA ECOSPORT ZETEC ROCAM

RH001



BOMBA COMB. FUSCA 1300/1500/1600
ALC/GAS

RH002



BOMBA COMB. PASSAT, GOL, SANTANA
ALC/GAS

RH003



BOMBA COMB. CORCEL, BALINA,
DEL REY - ALC/GAS

RH004



BOMBA COMB. MOTOR CHT FORD/WW
ALC/GAS

RH005



BOMBA COMB. MOTOR AP 2000
ALC/GAS

RH006



BOMBA COMB. FIAT ALC/GAS

RH007



BOMBA COMB. MONZA, KADETT
ALC/GAS















RH008

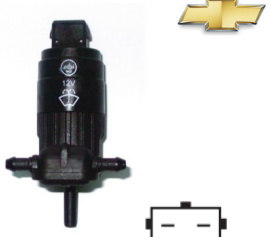

BOMBA COMB. CHEVETTE TODOS
ALC/GAS

Bombas Partida a Frio / Lavador



 <p>BF12 - VTO K 820 - Cebi Bomba gasolina partida a frio 1 saída - 12v Universal</p>	 <p>K 555 - Cebi Bomba gasolina partida a frio 1 saída - 12v Gol, Parati, Saveiro</p>	 <p>K 805 - Cebi Bomba lavador para brisas 1 saída - 12v Gol, Parati, Saveiro Código Original: 377 955651</p>	 <p>K 807 - Cebi Bomba lavador para brisas 2 saídas - 12v Gol, Parati Código Original: 377 955651 A</p>
 <p>K 847 - Cebi Bomba lavador para brisas 1 saída - 12v Santana, Quantum, Kombi Código Original: 305 955651 5</p>	 <p>K 801 - Cebi Bomba lavador para brisas 1 saída - 12v Corsa, Celta, Kadett, Omega, Suprema Código Original: 93 240405</p>	 <p>K 802 - Cebi Bomba lavador para brisas 2 saídas - 12v Corsa, Celta Código Original: 90 226604</p>	 <p>K 829 - Cebi Bomba lavador para brisas 1 saída - 12v Astra, Vectra Código Original: 93 276186</p>
 <p>K 832 - Cebi Bomba lavador para brisas 2 saídas - 12V Astra Código Original: 93 276187</p>	 <p>K 806 - Cebi Bomba gasolina partida a frio 1 saída - 12v Palio, Weekend Código Original: 46535935</p>	 <p>K 855 - Cebi Bomba gasolina partida a frio 1 saída - 12v Uno, Elba, Prêmio, Fiorino Código Original: 500 14364</p>	 <p>BG12 - VTO Bomba gasolina partida a frio 1 saída Bico Grosso - 12v</p>
 <p>BG2S - VTO Bomba lavador para brisas 2 saídas- Bico Grosso - 12v Ka, Fiesta Código Original: 85661</p>	 <p>K 856 - Cebi Bomba lavador para brisas 2 saídas - 12v Ka, Fiesta Código Original: XS61 11K624 BC</p>	 <p>K 857 - Cebi Bomba lavador para brisas 1 saída - 12v Ka, Fiesta, Courier Código Original: XS6111K624AC</p>	 <p>BFR2S - VTO Bomba lavador para brisa 2 saídas - 12v Megane, Scenic, Twingo, Laguna Código Original: 7700821782/ 7701048307</p>
 <p>BFR12 - VTO Bomba lavador para brisa 1 saída - 12v Megane, Scenic, Clio Código Original: 7704002215</p>	 <p>BGP2S - VTO Bomba lavador para brisa 2 saídas - Bico Grosso - 12v Peugeot 206,207,306,307 Citroën Xantia, Xsara, ZX, Berlingo Código Original: 643458</p>	 <p>BGCR12 - VTO Bomba lavador para brisa 1 saída - Bico Grosso - 12v Citroën C3, Renault Clio Código Original: 643458</p>	<p>VEJA TAMBÉM</p>  <p>Guarnição/Borracha Bomba Injetora Vide Índice</p>  <p>Valvula Solenóide Vide Índice</p>



Componentes para Injeção Eletrônica



 <p>2000 Módulo Injeção Eletrônica E.F.I. Corsa</p>	 <p>2001 Módulo Injeção Eletrônica E.F.I. Monza, Kadett, Ipanema</p>	 <p>2005 Tubo Flauta Distribuidor do Vácuo Monza, Kadett, Ipanema, Corsa</p>
 <p>2010 Tubo Flauta Distribuidor do Vácuo com 3 Tampas Monza, Kadett, Ipanema, Corsa</p>	 <p>2003 Conjunto de Filtros p/ Bicos Injetores "Single Point" Sistema Magnet Marelli S.P.i. VW, Ford, Fiat CFI</p>	 <p>2004 Conjunto de Filtros p/ Bicos Injetores "Single Point" Sistema Rochester EFI Linha GM</p>

Diafragmas e Válvula/Conector Injeção Eletrônica



 <p>LP-47405/041 Sistema - M. Marelli S.P.i. - CFI - VW, Ford, Fiat Similar: Autolex 206 006</p>	 <p>LP-47405/041KT Kit Diafragma LP-47405/041 Regulador de Pressão 2 membranas de víton</p>	
 <p>LP-47406/042 Sistema - Rochester EFI GM Similar: Autolex 206 004</p>	 <p>LP-47406/042KT Kit Diafragma LP-47406/042 Regulador de Pressão 1 membrana</p>	
 <p>LP-47414/071K Kit Diafragma regulador de pressão 2 membranas de víton Aplicação: FIAT: Tipo 1.6 ie, Siena 1.6 8V VW: Golf 1.8 GL SEAT: Cordoba SXE 1.8, Ibiza SXE PEUGEOT: 106 XE Todos Sistema Bosch (monomotronic)</p>	 <p>LP-204128/128 Válvula de Retenção Aplicação: Indicado para retenção e contra fluxo de diversos fluidos, inclusive ar. Dotado de tecnologia e materiais que conferem alta resistência à corrosão originalmente desenhada para a área de combustíveis e aplicações onde as bombas não possuem a capacidade de retenção em repouso. Aplicado em processos injetado ou carburado.</p>	 <p>C-U5 Conector Universal de Bico/Engate Rápido p/ Injeção Eletrônica - 5mm</p>



Diafragma Tampa de Válvulas

Somente indicado para alojamentos com tampas que não sejam coladas ou soldadas.

150

LP-204001/150

Diafragma Tampa de Válvula
Diâmetro: 88mm



VW Jetta, Novo Jetta, Tiguan
Passat FSI, Passat CC
Novo Fusca, Golf

Audi A4, A6, Q7

155

LP-204006/155

Diafragma Tampa de Válvula
Diâmetro: 68mm



Fiat Linea, Punto,
Bravo - Todos TJet

BWM 335 3.0
(Tampa soldada)

151

LP-204002/151

Diafragma Tampa de Válvula
Diâmetro: 84mm



BMW 120, 130i 2007 | 2012
318i, 318ci 2007 | 2013
316ti 2002 | 2013
316ti 2005 | 2013
Z4, X1, X3 2006 | 2012
Motores M52

156

LP-204007/156

022.103.515A

Diafragma Tampa de Válvula
Diâmetro: 58mm



VW Passat, Variant 1.8T,
Touareg, Passat CC V6

Audi A3, A4, TT 1.8, 1.8T, Q7

Porche Cayenne V6

152

LP-204003/152

Diafragma Tampa de Válvula
Diâmetro: 61mm



VW Passat, Variant 1.8 T

Audi A3, A4, TT 1.8, 1.8T

157

LP-204008/157

MB 66-24CFW 7A

Diafragma Tampa de Válvula
Diâmetro: 65mm



Volvo XC60, T5, T6

Land Rover Freelander 2

153

LP-204004/153

Diafragma Tampa de Válvula
Diâmetro: 60mm



BMW 320, X1 2012 |
118 2001 |
Motores N46

158

LP-204009/158

Diafragma Tampa de Válvula
Diâmetro: 63mm



Land Rover Freelander 2

154

LP-204005/154

Diafragma Tampa de Válvula
Diâmetro: 67mm



GM Cruze 1.8 16v. F18D4 2012 |
Ecotec
Tracker (Nova) 1.8 16v. 2013 |
F18D4 Ecotec
Sonic 1.6 16v. F16D4
Ecotec

159

LP-204010/159

Diafragma Tampa de Válvula
Diâmetro: 55mm



Volvo C3 10/, T5 2010/
5cc Aspirado
C70, S40, S60

154 KT

LP-204005/154 KT

KIT Diafragma Tampa de Válvula
Diâmetro: 67mm



GM Cruze 1.8 16v. F18D4 2012 |
Ecotec
Tracker (Nova) 1.8 16v. 2013 |
F18D4 Ecotec
Sonic 1.6 16v. F16D4
Ecotec (3 peças)

160

LP-204011/160

Diafragma Tampa de Válvula
Diâmetro: 77mm



Citroën C4, C4 Picasso,
DS3, DS4, DS5

Mini Cooper S,
Contryman S

Peugeot 2008, 3008, 208, 308,
408, 508 2016 16v THP

BMW 118i Urban 1.6 170CV 2011/2012

Diafragma Tampa de Válvulas

Somente indicado para alojamentos com tampas que não sejam coladas ou soldadas.

161

LP-204012/161

1127555 281
1127555 282

Diafragma Tampa de Válvula
Diâmetro: 60mm



BMW

Motores N 62 e N 65 545i 4.4L
550i 4.8L, 645Ci 4.4i, 650i 4.8L,
745i 4.4L, 750i 7.8L, 750Li 4.8L
V8 Aspirado Alpina B7 4.4L,
V8 Supercharged
X5 4.4L V8 e 3.0L Aspirado, Turbo
2004 | 2010
X5 4.8L, 4.6L V8 Aspirado
2004 | 2010
X6, 540, 740

166 KT

LP-204017/166 KT

789.840.722.0

Kit Diafragma Tampa de Válvula
Diâmetro: 67.5mm



Ford

Ranger 2.2 16v 2011 |
Transit 2.2 16v 2011 |
Transit 2.4 16v 2011 |

162

LP-204013/162

036129530

Diafragma Coletor de Admissão
Diâmetro: 28.7mm



VW

Fox 2004 |
Parati G2, G3, G4, Gol/ 2006 |
Voyage, Saveiro G2, G3, 2006 |
G5, G6 2006 |
Kombi Flex 1.4 2006 |
Golf 2000 |
Polo 2002 |
New Beetle 2006 |

Audi

A3 2001 |

167

LP-204018/167

Diafragma Tampa de Válvula
Diâmetro: 56.7mm



Citroën

Xsara Picasso 2.0 16v
C4 Pallas 2007 | 2012

Peugeot

306
307

163

LP-204014/163

Diafragma Tampa de Válvula
Diâmetro: 50mm



VW

Amarok 2.0 16v. Tdi

168

LP-204019/168

Diafragma Tampa de Válvula
Diâmetro: 56mm



Fiat

Uno, Mobi 1.0 12v 3cc
Motor FireFly

164

LP-204015/164

Diafragma Tampa de Válvula
Diâmetro: 54.2mm



BMW

Motores N20B20
120i, 125i, 320i, 420i, X1,
X3 20i, Z4 20i

Motores N20B26
328i, 428i, 528i, X4 28i

169

LP-204020/169

Diafragma Tampa de Válvula
Diâmetro: 73mm



VW

Touareg 3.2 24v V6

165

LP-204016/165

HBJJ291355
8200291355
RN291355

Diafragma Tampa de Válvula
Diâmetro: 57mm



Renault

Mégane II 2.0 16v F4R,
Grand Scénic

Citroën

C4 Pallas 2.0 16v 2010 | 2011

170

LP-204021/170

Diafragma Tampa de Válvula
Diâmetro: 66mm



VW

Touareg 4.2 V8 | 2017

BMW

Motores N51, N52
(N52B25 E N52B30),
N53 (N53B25 E N53B30)
X1 2.5 E 2.8 2000 |
X3 3.0 2000 |
Z4 3.0 | 2012
X5 | 2007
730i | 1996
530i | 1996
330i 2000 |
130i | 2012
528i | 2000
328i | 2003
125i 2000 |
630i 2000 |
128i 2000 |

166

LP-204017/166

789.840.722.0

Diafragma Tampa de Válvula
Diâmetro: 67.5mm



Ford

Ranger 2.2 16v 2011 |
Transit 2.2 16v 2011 |
Transit 2.4 16v 2011 |

Diafragma Tampa de Válvulas

Somente indicado para alojamentos com tampas que não sejam coladas ou soldadas.

171

LP-204022/171

Diafragma Tampa de Válvula
Diâmetro: 87mm



Porche Cayenne S 4.5, 4.8 V8 2011 |

176

LP-204027/176

Diafragma Tampa de Válvula
Diâmetro: 53mm



GM
S10 CTDI LTZ 2.8 16v Duramax Diesel 2010 |
S10 Cabine Dupla CTDI LTZ 2.8 16v 2010 |
Duramax Diesel
TrailBlazer CTDI LTZ 2.8 16v Diesel
LWH

172

LP-204023/172

Diafragma Coletor de Admissão
Diâmetro: 21.5mm



VW Up 1.4 Tsi

177

LP-204028/177

Diafragma Tampa de Válvula
Diâmetro: 76mm



VW
Up 1.0 170CV TSI 12v Flex
UP 1.0 TSI High 12v Flex
Up 1.0 TSI Move 12v Flex
Up 1.0 TSI Pepper 12v Flex
Up 1.0 TSI RBW 12v Flex
CrossUp 1.0 TSI 12v Flex
CrossUp 1.0 TSI Pepper 12v Flex

173

LP-204024/173

Diafragma Tampa de Válvula
Diâmetro: 76mm



Mini Cooper S 1.6 Turbo 2006 | 2013
Geração R 56
Motor N18 B16

178 KT

LP-204029/178 KT

Diafragma Tampa de Válvula
Diâmetro: 61mm



VW
Gol 1.0 MSI
Saveiro 1.0 MSI
Voyage 1.0 MSI

174

LP-204025/174

030129530A

Diafragma Coletor de Admissão
Diâmetro: 28.7mm



VW
Crossfox 2005 |
Spacefox 2006 |
Gol 2008 |
Voyage 2009 |
Saveiro 2010 |
Polo 1.6 2003 | 2015
Kombi 1.4 2006 | 2014
Golf 1.6 2001 | 2013
Fox 2004 |

Audi A 3 1.6 2001 | 2006

179

LP-204030/179

Diafragma Tampa de Válvula
Diâmetro: 68mm



Ford Ranger Motor 3.0 4cc Cummins

Troller T4 Motor 3.0 4cc Cummins

Citroën Jumper

175

LP-204026/175

Diafragma Tampa de Válvula
Diâmetro: 50mm



Mercedes Benz
Sprinter CDI 311 2.2 16v. OM 651 2012 |
Sprinter CDI 415 2.2 16v. OM 651 2012 |
Sprinter CDI 515 2.2 16v. OM 651 2012 |

180

LP-204031/180

Diafragma Tampa de Válvula
Diâmetro: 51mm



Porsche Cayenne
Panamera
Macan 3.6 V6 Turbo 2015 | 2016

206008

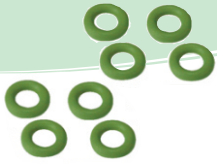

ANEIS BICO INJECAO ELETRONICA - JOGO COM 8 UN

LP-47406/042



DIAFRAGMA REG PRES I ELET ROCHESTER

LP-47206/206



REGULADOR DE PRESSAO - 3.0 BAR ASTRA 10-98/... GOL E PARATI 1.0 1.6 MI 97/... F000DR0206 / RP132002

LP-47575/207



REGULADOR DE PRESSAO - 4.0 BAR PASSAT 1.6/1.8 01-97/... BLAZER 4.3 V6 00/... - 0280160661 / RP133002

LP-810118/802



SENSOR DE ROTACAO - 64 CM ELBA/FIORINO MPI/TIPO/UNO 0261210118

810161/814



SENSOR DE ROTACAO - 66 CM PALIO 1.0/1.3 16V FIRE / SIENA 0261210161

LP-810532/811



SENSOR DE ROTACAO - 68 CM PALIO FIRE MPI/SIENA/UNO MILLE 0261210124

206009



ANEIS BICO INJECAO ELETRONICA CORSA/CELTA - JOGO COM 8 UN

LP-47406/042K



DIAFRAGMA REG PRES I ELET ROCHESTER - KIT COMPLETO

LP-47208/234



REGULADOR DE PRESSAO - 3.5 BAR UNO, SIENA, PALIO E DOBLO FIRE 00/... CELTA 1.0 00/... CLIO 00/...

LP-47583/218



REGULADOR DE PRESSAO - 2.7 BAR FIESTA 1.0/1.3 05-96/99 KA 1.0/1.3 97/99 COURIER MOTOR ENDURA 99/... 0280160583 / RP144002

LP-810124/803



SENSOR DE ROTACAO - 77 CM PALIO FIRE 03 / SIENA / UNO MILLE 0261210124

810179/815



SENSOR DE ROTACAO - 40 CM BORA E GOLF 1.6/0 0261210148/147/179

LP-810731/806



SENSOR DE ROTACAO - 40 CM FIORINO/PALIO MPI/SIENA/UNO MILLE 48020171010 / 46445731

LP-47405/041



DIAFRAGMA REG PRES I ELET MARELLI - LP

LP-47414/071K



DIAFRAGMA REG PRES I ELET C/ MOLA

LP-47209/209



REGULADOR DE PRESSAO - 3.0 BAR CORSA 00/... F000DR0209 / RP135002

LP-47601/249



REGULADOR DE PRESSAO - 3.8 BAR FOCUS 1.8 / 2.0 16V 00/... MARELLI Rp175002

LP-810128/804



SENSOR DE ROTACAO - 100 CM ASTRA 1.8/BLAZER 2.2/OMEGA/VECTRA 0261210128

810206/809



SENSOR DE ROTACAO - 46 CM ELBA 94/96 FIORINO / UNO MILLE SPI 93/01 - 4820083010 (SEM8D)

810975/813



SENSOR DE ROTACAO - 73 CM BRAVA SX/PALIO/SIENA/STRADA 1040211101

LP-47405/041K



DIAFRAGMA REG PRES I ELET MARELLI - KIT COMPLETO

LP-47560/204



REGULADOR DE PRESSAO - 3.0 BAR FIAT UNO 1.0/1.3 99/... PALIO/SIENA 1.0/1.3/1.5/1.6 16 V 96/... CLIO 1.0/1.6I / GOL 1.0 MI 96/... KOMBI 97/...

LP-47033/278



REGULADOR DE PRESSAO - 4.2 BAR FUSION 2.3 NEW CIVIC 1.8 I-VTEC 06/... MARELLI - RP204002

LP-47608/214



REGULADOR DE PRESSAO - 3.0 BAR BLAZER 2.2 MPFI 08-97/... VECTRA 2.2 MPFI 12-97/... BLAZER 4.0 S10 2.4 05-01/...

LP-810138/805



SENSOR DE ROTACAO - 74 CM IPANEMA/KADETT 0261210138

810442/807



SENSOR DE ROTACAO - 66 CM ASTRA/CORSA/MERIVA/MONTANA 90451442

LP-204128/128



VALVULA RETENCAO COMBUSTIVEL

Reguladores de Pressão



Código	Bosch	M. Marelli	DS
LP-47710/201	0280160710	RP127002	1151
LP-47716/202	0280160716	RP128002	1150
LP-47501/203		RP129002	1148
LP-47560/204	0280160560	RP13002	1152
LP-47551/205	0280160585 / 551	RP131002	1154
LP-47206/206	F000DR0206	RP132002	1153
LP-47575/207	0280160661	RP133002	1161
LP-47209/209	F000DR0209	RP135002	1164
LP-47001/213	DELPHI - PRD0001	RP139002	1163
LP-47608/214	0280160608	RP140002	1160
LP-47579/216	0280160576 / 579	RP142002	1159
LP-47583/218	0280160583	RP144002	1155
LP-47586/223	0280160586	RP149002	1182
LP-47208/234	F000DR0208 / 225	RP160002	1183
LP-47012/241		RP167002	1173
LP-47215/245	F00DR216	RP171002	1193
LP-47601/249		RP175002	1167
LP-47170/258	DENSO - 4170	RP184002	1133
LP-47222/262	F000DR0222	RP188002	1128
LP-47585/267		RP193002	1134
LP-47600/275	0280081600	RP201002	1158
LP-47033/278		RP204002	1123
LP-47038/283		RP209002	
LP-47442/284	F000DR00442	RP210002	
LP-47226/287		RP213002	1124

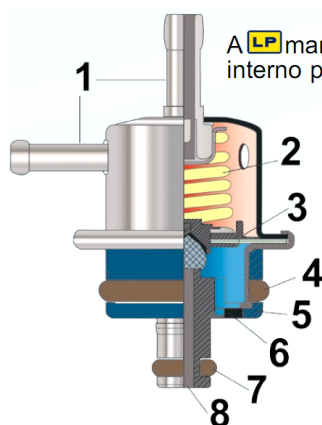

A **LP** mantém o mesmo padrão interno para todos os modelos

- 1) Conexão p/ o coletor de admissão
- 2) Mola de pressão
- 3) Diafragma
- 4) Anel oring de vedação
- 5) Filtro tela
- 6) Entrada de combustível
- 7) Oring de vedação retorno
- 8) Retorno de combustível



Bombas de Combustível



GI3103
Bomba Gasolina Interna Universal - 4 Bicos
2.8/3.2 BAR – gasolina - Mód. Bosch



GI3120
Bomba Flex (Bicombustível) Interna - 4 Bicos
2.8/4.2 BAR - álcool e bicombustível



GI3101 - GAUSS
10135 - EURO
3402 - Conam
Bomba Combustível - Externa ao tanque - Flex
Códigos compatíveis: 6443402 e Delphi: BCD00101



4070 - Conam
Bomba Combustível - 3.0 BAR
Gol GTI, Santana, Omega, Tempra - gasolina
Códigos compatíveis: Sistema Bosch 058044070
Org. 7700722393
Seat - Ibiza305906091-1



Sensor de Rotação



	Comprimento: 46 cm
	M. Marelli: 4820083010 (SEM8D) Fiat: 4460206
LP: 810206/809 YMAX-0206	
Elba CSL 4P 1.6 8V (SPI-gasolina) 94/96 Elba Weekend 2P/4P 1.5 8V (SPI-alcool/gasolina) 92/96 Fiorino Furgão/Pick-up 2P 1.0 8V (SPI-Gasolina) 96 Fiorino Furgão/Pick-up 2P 1.3 8V (SPI-Gasolina) 94/95 Fiorino Furgão 2P 1.5 8V (SPI-alcool/Gasolina) 94/96 Fiorino Pick-up 2P 1.5 8V (SPI-alcool/Gasolina) 94/95 Fiorino Pick-up LX 2P 1.6 8V (SPI-Gasolina) 94/96 Fiorino Pick-up trekking 2P 1.5 8V (SPI-Gasolina) 96 Fiorino Pick-up Trekking 2P 1.5 8V (MPI-Gasolina) 97/98 Fiorino Pick-up Trekking MTV 2P 1.5 8V (MPI-Gasolina) 97 Fiorino Pick-up Working 2P 1.5 8V (SPI-Gasolina) 96 Prêmio CS 4P 1.5 8V (SPI-alcool/gasolina) 93/94 Prêmio CSL 4P 1.6 8V (SPI-gasolina) 94/96 Prêmio S 2P 1.5 8V (SPI-gasolina) 92/93 Prêmio SL 4P 1.5 8V (SPI-gasolina) 92 Uno CS 2P/4P 1.5 8V (SPI-alcool-gasolina) 93/94 Uno Furgoneta 2P 1.5 8V (SPI-alcool-gasolina) 94/96 Uno Mille City 4P 1.0 8V (SPI-gasolina) 99/00 Uno Mille Electronic 2P/4P 1.3 8V (SPI-gasolina) 93/95 Uno Mille ELX 2P/4P 1.3 8V (SPI-gasolina) 94/95 Uno Mille EP 2P/4P 1.0 8V (SPI-gasolina) 96 Uno Mille EX 2P/4P 1.0 8V (SPI-asolina) 98/00 Uno Mille IE 2P 1.0 8V (SPI-gasolina) 94 Uno Mille Smart 2P/4P 1.0 8V (SPI-gasolina) 00/01 Uno Mille Smart City 4P 1.0 8V (SPI-gasolina) 00/01 Uno Mille SX 2P/4P 1.0 8V (SPI-gasolina) 97/98 Uno Mille SX Young 2P 1.0 8V (SPI-gasolina) 98/99 Uno SP 2P 1.5 8V (SPI-alcool-gasolina) 92/94	

	Comprimento: 73 cm
	M. Marelli: 1040211101 Fiat: 46774532 55187333
LP: 810975/813 YMAX-0124	
Brava SX, ELX 4P 1.6 16V(MPI-Gasolina) 00/03 Doblo Cargo 2P 1.6 16V(MPI-gasolina) 02/03 Doblo ELX 2P 1.6 16V (MPI-Gasolina) 02/03 Marea, Marea Weekend SX 4P 1.6 16V(MPI-Gasolina) 06 Palio 2P 1.6 16V (MPI-Gasolina) 96/98 Palio 4P 1.6 16V (MPI-Gasolina) 96/00 Palio ELX 4P 1.6 16V 01/03 Palio Stile 4P 1.6 16V (MPI-Gasolina) 01/02 Palio Adventure 4P 1.6 16V(MPI-gasolina) 01/03 Palio Weekend 4P 1.6 16V (MPI-Gasolina) 97/98 Palio Weekend Sport 4P 1.6 16V (MPI-Gasolina) 97/00 Palio Weekend Stille 4P 1.6 16V (MPI-Gasolina) 97/03 Siena EL 4P 1.6 16V (MPI-Gasolina) 98 Siena ELX 4P 1.6 16V (MPI-Gasolina) 01/03 Siena HL 4P 1.6 16V (MPI - Gasolina) 98 Siena Sport MTV 4P 1.6 16V (MPI- gasolina) 98 Siena Stile 4P 1.6 16V (MPI-Gasolina) 98/99 Strada LX 2P 1.6 16V (MPI-Gasolina) 99/00 Strada LX estendida 2P 1.6 16V (MPI-Gasolina) 00/02 Strada Working estendida 2P 1.6 16V (MPI-Gasolina) 1 Strada Working 2P 1.6 16V (MPI-Gasolina) 2 Strada Adventure 2P 1.6 16V(MPI-gasolina) 2	

	Comprimento: 68 cm
	BOSCH: 0.261.210.124 Fiat: 46774532 55187333
LP: 810532/811	
Fiorino Furgão Fire 2P 1.3 8V (MPI-Gasolina) 00/... Palio EX Fire 2P/4P 1.0 8V (MPI-Gasolina) 01/03 Palio EX Fire 2P/4P 1.3 8V (MPI-Gasolina) 03 Palio EX Fire 2P 1.0 8V (MPI-alcool-Gasolina) 06/... Palio EX Fire 4P 1.0 8V (MPI-alcool/Gasolina) 06/... Palio ELX Fire Flex 4P 1.0 8V (MPI-alcool/Gasolina) 04/05 Palio Fire 2P/4P 1.0 8V (MPI-Gasolina) 00/... Palio Fire Flex 2P/4P 1.0 8V (MPI-alcool-Gasolina) 04 Palio Penta Fire 4P 1.0 8V (MPI-Gasolina) 06/... Palio Weekend EX Fire 4P 1.3 8V (MPI-Gasolina) 03 Palio Weekend ELX Fire 4P 1.3 8V (MPI-alcool-Gasolina) 03/05 Palio Young Fire 2P/4P 1.0 8V (MPI-Gasolina) 02 Siena Fire 4P 1.0 8V (MPI-gasolina) 02/03 Siena Fire Flex 4P 1.0 8V (MPI-alcool-gasolina) 06/... Siena EX Fire 4P 1.3 8V (MPI-gasolina) 03/04 Siena ELX Fire Flex 4P 1.3 8V (MPI-alcool-gasolina) 05 Siena ELX Fire Flex 4P 1.0 8V (MPI-alcool-gasolina) 06/... Strada Fire 2P 1.3 8V(MPI-gasolina) 03/05 Strada Fire estendida 2P 1.3 8V(MPI-gasolina) 03/05 Uno Forgoneta Fire 2P 1.3 8V(MPI-Gasolina) 03 Uno Mille Fire 2P/4P 1.0 8V(MPI-Gasolina) 02/06 Uno Mille Fire Flex 2P/4P 1.0 8V(MPI-alcool-Gasolina) 06/...	

	Comprimento: 78 cm
	BOSCH: 0.261.210.161 Fiat: 46474583 55187332
LP: 810583/810 YMAX-0161	
Palio 1.0 16V, 1.3 16V (Fire) 03/00 Palio Weekend 1.0 16V, 1.3 16V (Fire) 03/00 Siena 1.0 16V, 1.3 16V(Fire) 03/00 Strada 1.3 16V (Fire) 03/00	

	Comprimento: 73 cm
	M. Marelli: 1040211101 Fiat: 46774532 55187333
LP: 810975/813 YMAX-0124	
Brava SX, ELX 4P 1.6 16V(MPI-Gasolina) 00/03 Doblo Cargo 2P 1.6 16V(MPI-gasolina) 02/03 Doblo ELX 2P 1.6 16V (MPI-Gasolina) 02/03 Marea, Marea Weekend SX 4P 1.6 16V(MPI-Gasolina) 06 Palio 2P 1.6 16V (MPI-Gasolina) 96/98 Palio 4P 1.6 16V (MPI-Gasolina) 96/00 Palio ELX 4P 1.6 16V 01/03 Palio Stile 4P 1.6 16V (MPI-Gasolina) 01/02 Palio Adventure 4P 1.6 16V(MPI-gasolina) 01/03 Palio Weekend 4P 1.6 16V (MPI-Gasolina) 97/98 Palio Weekend Sport 4P 1.6 16V (MPI-Gasolina) 97/00 Palio Weekend Stille 4P 1.6 16V (MPI-Gasolina) 97/03 Siena EL 4P 1.6 16V (MPI-Gasolina) 98 Siena ELX 4P 1.6 16V (MPI-Gasolina) 01/03 Siena HL 4P 1.6 16V (MPI - Gasolina) 98 Siena Sport MTV 4P 1.6 16V (MPI- gasolina) 98 Siena Stile 4P 1.6 16V (MPI-Gasolina) 98/99 Strada LX 2P 1.6 16V (MPI-Gasolina) 99/00 Strada LX estendida 2P 1.6 16V (MPI-Gasolina) 00/02 Strada Working estendida 2P 1.6 16V (MPI-Gasolina) 1 Strada Working 2P 1.6 16V (MPI-Gasolina) 2 Strada Adventure 2P 1.6 16V(MPI-gasolina) 2	



Sensor de Rotação



	Comprimento: 66 cm BOSCH: 0.261.210.161 Fiat: 46474583 55187332
LP: 810161/814	
Palio 1.0 16V, 1.3 16V (Fire) Palio Weekend 1.0 16V, 1.3 16V(Fire) Siena 1.0 16V, 1.3 16V(Fire) Siena 1.3 16V(Fire)	03-00/... 03-00/... 03-00/... 03-00/...

	Comprimento: 87 cm Bosch: 0.261.210.150 GM: 93.243.251 Opel: 1.238.241
LP: 810150/801	
Astra 2.0i 16V Vectra 2.2 16V Vectra CD 2.0 16V	99/... 97/... 96/...

	Comprimento: 68 cm Fiat: 708.33.27 708.37.91 933.938.67
LP: 810302/817	
Palio 1.8 8V Flex Siena 1.8 8V Flex Strada 1.8 8V Flex Doblo 1.8 8V Flex	Motor GM Powertrain

	Comprimento: 74 cm GM: 90.337.650 90.483.739
LP: 810650/812 YMAX-7650	
Corsa 1.6 16V (GSI) Corsa 1.0 16V Corsa 1.6 Tigra	95/96 99/... 95/01 98



	Comprimento: 100m Bosch: 0.261.210.128 0.261.210.030 GM: 90.451.441 90.213.515 Siemens/VDO: 324003007R
LP: 810128/804 YMAX-0128	
Astra 1.8i, 2.0i Astra 2.0(MPFI) Blazer, S10 2.2 (MPFI) Blazer, S10 2.4 (MPFI) Calibra Omega Omega, Suprema GLS 2.0 Vectra 2.2i Vectra GLS 2.0 (MPFI) Vectra Cd 2.0 8V, Vectra GLS 2.0 (MPFI) Vectra GSI 2.0 16V	10-98/... 09-94/96 08-97/... 12-00/... 94/95 93/95 09-92/... 12-97/... 04-96/... 93/96 10-93/...

	Comprimento: 68 cm GM: 70.833.27 70.837.91 93.393.867
LP: 810302/817	
Corsa 1.8 8V Flex Meriva 1.8 8V Flex Santana 1.8 8V Flex	



	CKP/CMP Peugeot: 964.031.6180.1920CT
LP: 810180/818	
206 1.0 16V	01/...



	Comprimento: 74 cm GM: 0.261.210.138
LP: 810138/805	
Ipanema, Kadett 2.0 MPFI 01.	97/...

	Saída para o Lado Direito Renault: 7700103069 7700875184B
LP: 810069/820 YMAX-1969	
Clio, Scenic 1.0 8V/16V e 1.6 8V Twingo, Kangoo 1.0 8V/16V e 1.6 8V	01/... 01/...

	Comprimento: 66 cm GM: 90.451.442 Siemens/VDO: 324003001R
LP: 810442/807 YMAX-1442	
Astra 1.6 16V (MPFI) Celta 1.0 8V (MPFI) Corsa 1.0, 1.4, 1.6 8V (EFI/MPFI) Corsa 1.0 8V (MPFI) Corsa 1.0, 1.4, 1.6 8V (MPFI-Flex) Corsa 1.8 8V (MPFI) Meriva 1.8 8V (MPFI-Flex) Montana 1.8 8V (MPFI-Flex) Montana 1.4 8V	03-04/... 01-02/... 08-97/... 96/... 95/... 02-03/... 02-04/... 03-04/... 04-05/... 07/...

	Saída para o Lado Esquerdo Renault: 7700101970 7700103069A
LP: 810442/807 YMAX-1442	
Clio, Scenic 1.0 e 1.6 16V Twingo, Kangoo 1.0 8/16V e 1.6 8V	01/... 01/...



Atuador de Marcha Lenta / Motor de Passo



95BF9F715AC

Fiesta, Ka, Courier - Endura
1.0/1.3 MPI MT 96/99
Courier 1.3 MPI MT - Endura
Escort 16V 1.8 MPI 96/99

Gasolina - Todos

Cod. Original: 95BF-9F715-AB/AC

M. Marelli: MMCA001BPM, MTE: 7464



EMP8102

FORD: Fiesta 1.0/1.6 Flex 01/...
Ecosport 1.6 Flex, Fusion, Ka
Cod. Original: 2S6A 9F715BA
2S6A 9F715BB/ 1149683



10511

Ka, Fiesta, Courier 00/05
Motor Endura e Zetec Rocam
Cod. Original: XS4U3F715DB



Atuador de Marcha Lenta Motor de Passo



B2800

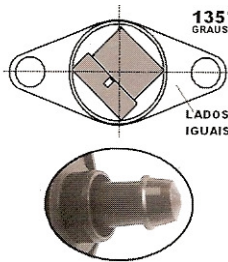
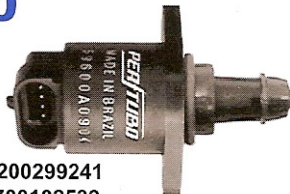

Renault: 8200299241
Antigo: 7700102539
Nr. MAGNETI: -----

00600

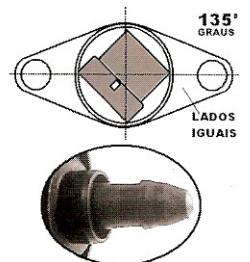
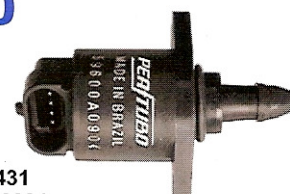

Peugeot: 1920N1
Citroën: 1920N1
Renault: novo: 8200211431
Antigo: 7700870084
Nr. MAGNETI: -----

D5103

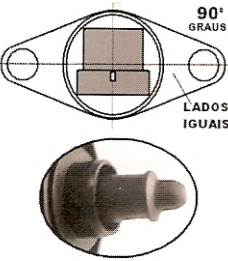

Fiat: 7077213
Renault: -----
Nr. MAGNETI: 403.971.02

B1300

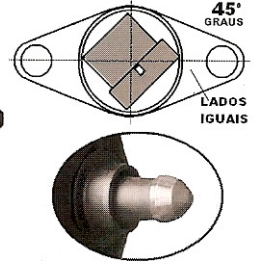

Citroën: 1920V7
Peugeot: 1920V7
Nr. MAGNETI: -----

B0201

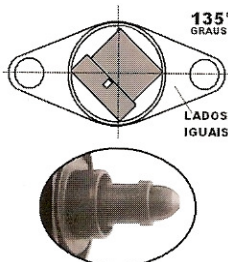

Fiat: 9945635
Nr. MAGNETI: 9244290500

B3300

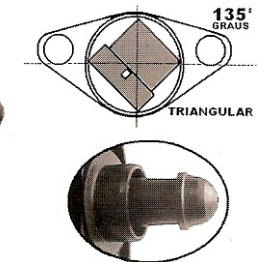
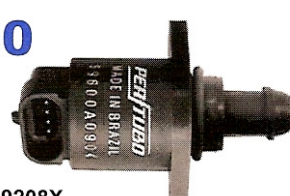

Citroën: 19208X
Nr. MAGNETI: -----

B0801

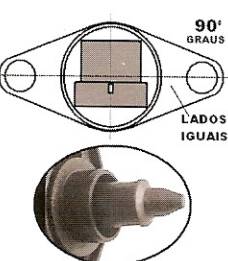

Fiat: 7076356
Ford: F5PF9N825.AA
VW: 026.906.049.1
Nr. MAGNETI: 403.802.02

B2001

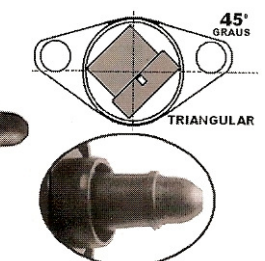
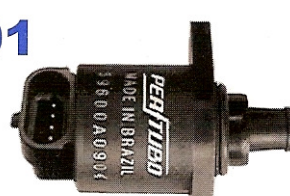

Fiat: 46451794
Nr. MAGNETI: 404.152.02

B3400

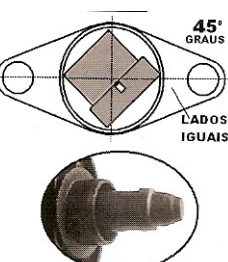

VW: 026.906.247.A
Nr. MAGNETI: 404.403.02

D5104

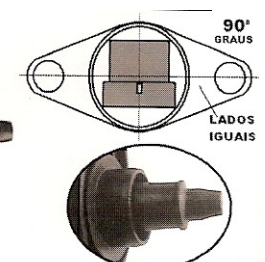

Fiat: 7078983
VW: 026.998.049-2
Nr. MAGNETI: 403.965.02

B3401

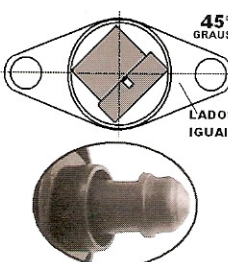

VW: 026.906.247
Nr. MAGNETI: 404.391.02

D5150

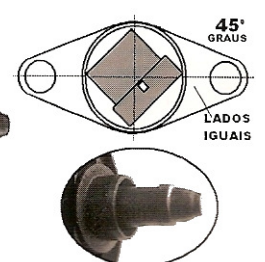

Fiat: 7079064
VW: 027.998.049.1
Seat: 027.998.049.1
Nr. MAGNETI: 404.301.02



Atuador de Marcha Lenta Motor de Passo



08187

LADO MENOR

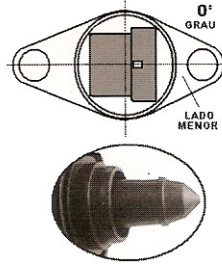

Fiat:
GM: 17108187
Nr. DELPHI: ICD00124

59600

LADO MENOR

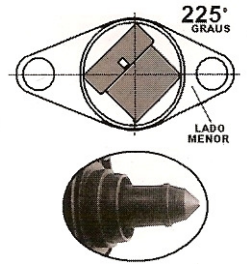

GM: 17059600
Nr. DELPHI: ICD00126

13209

LADO MENOR

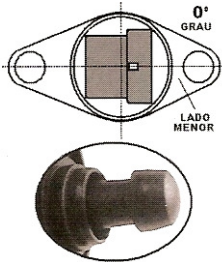

GM: 17113209
Nr. DELPHI: ICD00004

59602

LADO MENOR

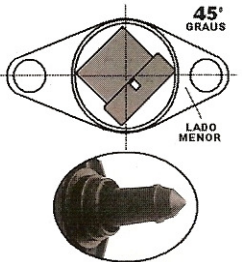

GM: 17059602
Nr. DELPHI: ICD00120

59524

LADO MENOR

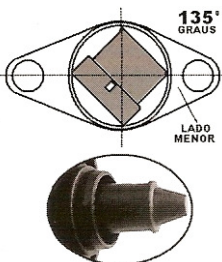

GM: 17059524
Nr. DELPHI: ICD00127

59603

LADO MENOR

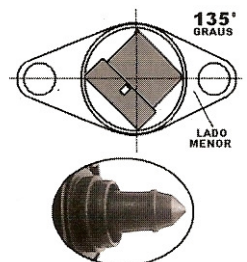

GM: 17059603
Nr. DELPHI: ICD00125

B2300

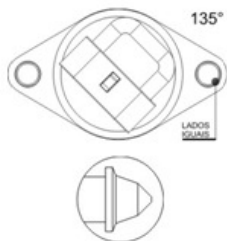

Renault: 7700105042/ AT02300R
B23/00/ 7701042403/ D95129

B3100

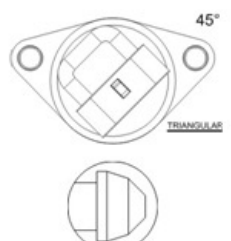

Peugeot: 034595/ AT03100R/ B31/00

B0401

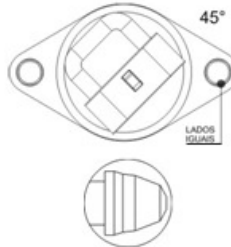

Citroën: 1920X9/ 1920N1
AT00401R/ B04/01/ A95269
Peugeot: 1920X9/ 1920N1
AT00401R/ B04/01/ A95269

D5177

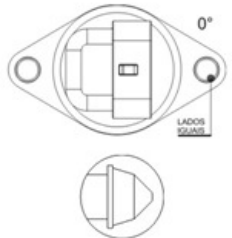

Renault: 7700273699
AT05177R/ D95177



Atuador de Marcha Lenta

Motor de Passo



Volkswagen

Código	Aplicação	Nº Orig.	Magnet	Ano	Combustível	Sist.
P-D5104	GOL 1.0	026.998049-2	403.965.02	94/96	GASOLINA	SPI
P-B0801	GOL 1.6/1.8	026.906049.1	403.802.02	94/96	GAS./ÁLC.	SPI
P-D5150	GOL 1.6/1.8	027.998049.1	404.301.02	96/05.02	GAS./ÁLC.	MPI
P-B3401	GOL 1.6	026.906.247	404.391.02	06.02/...	TOTALFLEX	MPI
P-B3400	GOL 1.6	026.906.247.A	404.403.02	06.02/...	GAS./ÁLC.	MPI
P-B3400	GOL 1.8	026.906.247.A	404.403.02	06.02/...	ÁLCOOL	MPI
P-B3401	GOL 1.8	026.906.247	404.391.02	06.02/...	GASOLINA	MPI
P-B0801	GOL 2.0 16V	026.906049.1	403.802.02	95/96	GASOLINA	SPI
P-D5150	GOL 2.0 8V 16V	027.998049.1	404.301.02	96/...	GASOLINA	MPI
P-B0801	LOGUS 1.6/1.8	026.906049.1	403.802.02	95/96	GAS./ÁLC.	SPI
P-B0801	PARATI 1.6/1.8	026.906049.1	403.802.02	94/96	GAS./ÁLC.	SPI
P-D5150	PARATI 1.6/1.8	027.998049.1	404.301.02	96/05.02	GAS./ÁLC.	MPI
P-B3401	PARATI 1.6	026.906.247	404.391.02	06.02/...	TOTALFLEX	MPI
P-B3400	PARATI 1.6	026.906.247.A	404.403.02	06.02/...	GAS./ÁLC.	MPI
P-B3400	PARATI 1.8	026.906.247.A	404.403.02	06.02/...	ÁLCOOL	MPI
P-B3401	PARATI 1.8	026.906.247	404.391.02	06.02/...	GASOLINA	MPI
P-D5150	PARATI 2.0	027.998049.1	404.301.02	06/05.02	GASOLINA	MPI
P-B3400	PARATI 2.0	026.906.247.A	404.403.02	06.02/...	GASOLINA	MPI
P-B0801	PARATI 2.0 16V	026.906049.1	403.802.02	95/96	GASOLINA	SPI
P-D5150	PARATI 2.0 16V	027.998049.1	404.301.02	96/...	GASOLINA	MPI
P-B0801	POINTER 1.8	026.906049.1	403.802.02	95/96	GAS./ÁLC.	SPI
P-D5150	POLO CLASSIC 1.6/1.8	027.998049.1	404.301.02	96/...	GASOLINA	MPI
P-B0801	QUANTUM 1.8	026.906049.1	403.802.02	95/96	GAS./ÁLC.	SPI
P-D5150	QUANTUM 1.8	027.998049.1	404.301.02	96/...	GAS./ÁLC.	MPI
P-D5150	QUANTUM 2.0	027.998049.1	404.301.02	96/05.02	GAS./ÁLC.	MPI
P-B3400	QUANTUM 2.0	026.906.247.A	404.403.02	06.02/...	GASOLINA	MPI
P-B0801	SANTANA 1.8	026.906049.1	403.802.02	95/96	GAS./ÁLC.	SPI
P-D5150	SANTANA 1.8	027.998049.1	404.301.02	96/...	GAS./ÁLC.	MPI
P-D5150	SANTANA 2.0	027.998049.1	404.301.02	96/05.02	GAS./ÁLC.	MPI
P-B3400	SANTANA 2.0	026.906.247.A	404.403.02	06.02/...	GASOLINA	MPI
P-D5150	SAVEIRO 1.6/1.8	027.998049.1	404.301.02	96/05.02	GAS./ÁLC.	MPI
P-B3401	SAVEIRO 1.6	026.906.247	404.391.02	06.02/...	TOTALFLEX	MPI
P-B3400	SAVEIRO 1.6	026.906.247.A	404.403.02	06.02/...	GAS./ÁLC.	MPI
P-B3400	SAVEIRO 1.8	026.906.247.A	404.403.02	06.02/...	ÁLCOOL	MPI
P-B3401	SAVEIRO 1.8	026.906.247	404.391.02	06.02/...	GASOLINA	MPI
P-D5150	SAVEIRO 2.0	027.998049.1	404.301.02	96/...	GASOLINA	MPI
P-D5150	VAN 1.6	027.998049.1	404.301.02	96/98	GASOLINA	MPI



Atuador de Marcha Lenta

Motor de Passo



Fiat

Código	Aplicação	Nº Orig.	Magnet	Ano	Combustível	Sist.
P-B0201	BRAVA 1.6 16V	9945635	9244290500	00/...	GASOLINA	MPI
P-B0801	ELBA 1.5	7076356	403.802.02	92/96	GASOLINA	SPI
P-D5103	ELBA 1.5/1.6	7077213	403.971.02	94/96	GAS./ÁLC	SPI
P-B0801	FIORINO FURGÃO 1.5	7076356	403.802.02	94/96	GASOLINA	SPI
P-D5103	FIORINO FURGÃO 1.5	7077213	403.971.02	94/96	ÁLCOOL	SPI
P-B2001	FIORINO FURGÃO 1.5	46451794	404.152.02	97/98	GASOLINA	MPI
P-B2001	FIORINO FURGÃO 1.5	46451794	404.152.02	98/...	BENZINA	MPI
P-B0801	FIORINO PICK-UP 1.5/1.6	7076356	403.802.02	94/96	GASOLINA	SPI
P-D5103	FIORINO PICK-UP 1.5	7077213	403.971.02	94/96	ÁLCOOL	SPI
P-D5103	FIORINO PICK-UP 1.6	7077213	403.971.02	94/96	GASOLINA	SPI
P-B2001	FIORINO PICK-UP 1.5	46451794	404.152.02	97/98	GASOLINA	MPI
P-B2001	PALIO 1.0/1.5	46451794	404.152.02	96/98	GAS./ÁLC	MPI
P-D5104	PALIO 1.3	7078983	403.965.02	96/...	BENZINA	SPI
P-B2001	PALIO 1.3	46451794	404.152.02	98/...	GAS./BENZ	MPI
P-D5104	PALIO 1.6	7078983	403.965.02	98/99	GASOLINA	SPI
P-D5104	PALIO 1.6	7078983	403.965.02	99/...	BENZINA	SPI
P-B0201	PALIO 1.6	9945635	9244290500	99/00	GASOLINA	MPI
P-B0201	PALIO 1.6 16V	9945635	9244290500	96/00	GASOLINA	MPI
P-B2001	PALIO SIENA 1.0	46451794	404.152.02	96/98	GASOLINA	MPI
P-D5104	PALIO SIENA 1.6	7078983	403.965.02	98/99	GASOLINA	SPI
P-B2001	PALIO SIENA 1.5	46451794	404.152.02	99/...	ÁLCOOL	MPI
P-D5104	PALIO SIENA 1.3	7078983	403.965.02	96/...	BENZINA	SPI
P-D5104	PALIO SIENA 1.6	7078983	403.965.02	99/...	BENZINA	SPI
P-B0201	PALIO SIENA 1.6 8V 16V	9945635	9244290500	98/00	GASOLINA	MPI
P-08187	PALIO 1.8 ADVENTURE	-----	ICD00124	04/...	HI-FLEX	MPI
P-B2001	PALIO STRADA 1.5	46451794	404.152.02	96/98	GASOLINA	MPI
P-B0201	PALIO STRADA 1.6 8V 16V	9945635	9244290500	99/...	GASOLINA	MPI
P-08187	PALIO STRADA 1.8	-----	ICD00124	04/...	HI-FLEX	MPI
P-B2001	PALIO WEEKEND 1.0/1.5	46451794	404.152.02	97/...	GAS./ÁLC	MPI
P-B0201	PALIO WEEKEND 1.6 8/16V	9945635	9244290500	97/00	GASOLINA	MPI
P-B0801	PRÊMIO 1.5	7076356	403.802.02	92/96	GASOLINA	SPI
P-D5103	PRÊMIO 1.5	7077213	403.971.02	94/96	ÁLCOOL	SPI
P-D5103	PRÊMIO 1.6	7077213	403.971.02	94/95	GASOLINA	SPI
P-D5103	TEMPRA 2.0	7077213	403.971.02	94/99	GASOLINA	SPI
P-B0801	TEMPRA 2.0	7076356	403.802.02	94/96	ÁLCOOL	SPI
P-D5103	TEMPRA 2.0	7077213	403.971.02	96/99	ÁLCOOL	SPI
P-B0801	TEMPRA 2.0 16V	7076356	403.802.02	95/96	GASOLINA	MPI
P-D5150	TEMPRA 2.0 16V	7079064	404.301.02	97/99	GASOLINA	MPI
P-D5103	UNO 1.0	7077213	403.971.02	97/...	GASOLINA	SPI
P-B2001	UNO 1.0	46451794	404.152.02	99/...	ÁLCOOL	MPI
P-B0801	UNO 1.0	7076356	403.802.02	94/...	GASOLINA	SPI
P-B0801	UNO 1.5	7076356	403.802.02	92/96	GASOLINA	SPI
P-D5103	UNO 1.5/1.6	7077213	403.971.02	94/96	GAS./ÁLC	SPI
P-B2001	UNO FORGONEA 1.5	46451794	404.152.02	97/98	GASOLINA	MPI



Atuador de Marcha Lenta

Motor de Passo



GM

Código	Aplicação	Nº Orig.	Magnet	Ano	Combustível	Sist.
P-59600	BLAZER	17059600	ICD00126	91/96	GAS./ÁLC.	EFI
P-13209	BLAZER 4.3 V6	17113209	ICD00004	97/...	GASOLINA	-----
P-08187	CELTA	17108187	ICD00124	01/...	GASOLINA	MPFI
P-59524	CORSA 1.0/1.4/1.6	17059524	ICD00127	94/96	GASOLINA	EFI
P-08187	CORSA TODOS	17108187	ICD00124	96/...	GASOLINA	MPFI
P-08187	CORSA 1.8	17108187	ICD00124	04/...	FLEXPOWER	MPFI
P-59603	CORSA 1.6	17059603	ICD00125	94/96	GASOLINA	EFI
P-59600	KADETT	17059600	ICD00126	91/96	GAS./ÁLC.	EFI
P-08187	MARIVA 1.8	17108187	ICD00124	04/...	GASOLINA	MPFI
P-08187	MERIVA 1.8 (FLEXPOWER)	17108187	ICD00124	04/...	FLEXPOWER	MPFI
P-59600	MONZA	17059600	ICD00126	91/96	GAS./ÁLC.	EFI
P-08187	MONTANA 1.8	17108187	ICD00124	04/...	FLEXPOWER	MPFI
P-59602	OMEGA 2.2	17059602	ICD00120	94/...	GASOLINA	-----
P-13209	S-10	17113209	ICD00004	97/...	GASOLINA	-----
P-59600	S-10	17059600	ICD00126	91/96	GAS./ÁLC.	EFI



Ford

Código	Aplicação	Nº Orig.	Magnet	Ano	Combustível	Sist.
P-B0801	ESCORT 1.6/1.8	F5PF9N825.AA	403.802.02	95/96	GAS./ÁLC.	SPI
P-B0801	PAMPA 1.8	F5PF9N825.AA	403.802.02	95/96	GASOLINA	SPI
P-B0801	ROYALE 1.8	F5PF9N825.AA	403.802.02	95/96	GAS./ÁLC.	SPI
P-B0801	VERONA 1.6/1.8	F5PF9N825.AA	403.802.02	95/96	GAS./ÁLC.	SPI
P-B0801	VERSAILLES 1.8	F5PF9N825.AA	403.802.02	95/96	GAS./ÁLC.	SPI



Citroën

Código	Aplicação	Nº Orig.	Magnet	Ano	Combustível	Sist.
P-00600	BERLINGO 2.0	1920N1	-----	00/...	GASOLINA	MPI
P-00600	XSARA/XZ 1.8 8V e 2.0 8V	1920N1	-----	00/...	GASOLINA	MPI
P-B1300	XSARA 1.8 16V	1920V7	-----	00/...	GASOLINA	MPI
P-B3300	XSARA PICASSO 2.0 16V	19208X	-----	01/...	GASOLINA	MPI
P-B0401	XANTIA 1.8 8V e 2.0 16V	1920X9		.../97	GASOLINA	MPI



Peugeot

Código	Aplicação	Nº Orig.	Magnet	Ano	Combustível	Sist.
P-00600	306 1.8/2.0 8V 16V	1920N1	-----	93/...	GASOLINA	MPI
P-B1300	306 1.8 16V	1920V7	-----	00/...	GASOLINA	MPI
P-00600	405, 406 1.8/2.0 8V 16V	1920N1	-----	93/...	GASOLINA	MPI
P-B3100	TODOS 206 1.6 8V	O34595			GASOLINA	MPI
P-B0401	306 2.0 16V (Caixa de Comando AMC)	1920X9		93/...	GASOLINA	MPI
P-B0401	405 1.8 8V (Caixa de Comando AMC)	1920X9		93/...	GASOLINA	MPI
P-B0401	405 2.0 16V (Caixa de Comando AMC)	1920X9			GASOLINA	MPI
P-B0401	406 2.0	1920X9			GASOLINA	MPI



Atuador de Marcha Lenta Motor de Passo



Renault

Código	Aplicação	Nº Orig.	Magnet	Ano	Combustível	Sist.
P-B2300	CLIO 1.0 8V (C/ MOTOR 7D7)	7.700.105.042		00/...	GASOLINA	MPI
P-D5103	CLIO 1.6	-----	403.971.02	97/...	GASOLINA	SPI
P-D5177	CLIO 1.6 8V (C/ MOTOR K7M)	7.700.273.699		00/...	GASOLINA	MPI
P-B2800	CLIO 1.6 16V	8200299241	7700102539	00/...	GASOLINA	MPI
P-00600	CLIO, TWINGO 8V	8200211431	7700870084	00/...	GASOLINA	MPI
P-B2300	KANGOO 1.0 (C/ MOTOR D7D)	7.700.105.042		00/...	GASOLINA	MPI
P-D5177	KANGOO 1.6 8V (C/ MOTOR K7M)	7.700.273.699		00/...	GASOLINA	MPI
P-B2800	MÉGANE 1.6 16V 2.0 16V	8200299241	7700102539	00/...	GASOLINA	MPI
P-00600	MÉGANE 2.0 8V	8200211431	7700870084	00/...	GASOLINA	MPI
P-D5103	R 19 1.6	-----	403.971.02	96/...	GASOLINA	SPI
P-B2800	SCÉNIC 1.6 16V 2.0 16V	8200299241	7700102539	00/...	GASOLINA	MPI
P-00600	SCÉNIC 2.0 8V	8200211431	7700870084	00/...	GASOLINA	MPI
P-B2300	TWINGO 1.0 8V (C/ MOTOR D7D)	7.700.105.042		00/...	GASOLINA	MPI



Seat

Código	Aplicação	Nº Orig.	Magnet	Ano	Combustível	Sist.
P-D5150	INCA 2.0	027.998049.1	404.301.02	97/98	GASOLINA	MPI



Tabela de Equivalência

Código	Equivalência TC Chicotes	Equivalência Rainha das Sete
TH-8001	TC-1005	ETE-7743
TH-8002	TC-1007	ETE-7877
TH-8003	TC-1012	ETE-7881
TH-8004	TC-1014	ETE-7735
TH-8005	TC-1016	ETE-7742
TH-8006	TC-1017	ETE-7733
TH-8007	TC-1018	ETE-7731
TH-8008	TC-1020	ETE-7770
TH-8009	TC-1021	ETE-7728
TH-8010	TC-1019	ETE-7988
TH-8011	TC-1023	nt
TH-8012	TC-1024	ETE-7725
TH-8013	TC-1027	ETE-7745
TH-8014	TC-1028	ETE-7740
TH-8015	TC-1029	ETE-7741
TH-8016	TC-1030	ETE-7780
TH-8017	TC-1032	ETE-7746
TH-8018	TC-1035	ETE-7709
TH-8019	TC-1036	ETE-7886
TH-8020	TC-1037	ETE-7759
TH-8021	TC-1046	ETE-7747
TH-8022	TC-1047	ETE-7774
TH-8023	TC-1048	ETE-7775
TH-8024	TC-1049	ETE-7989
TH-8025	TC-1050	ETE-7776
TH-8026	TC-1051	ETE-7777
TH-8027	TC-1055	ETE-7791
TH-8028	TC-1061	ETE-7993
TH-8029	TC-1063	ETE-7778
TH-8030	TC-1082	nt
TH-8031	TC-1089	ETE-775
TH-8033	TC-1112	nt
TH-8035	TC-1133	ETE-7786
TH-8036	TC-1206	ETE-5058
TH-8037	TC-1224	ETE-7793
TH-8038	TC-1216	ETE-5012
TH-8038A	TC-1218	ETE-5013
TH-8039	TC-1226	ETE-7756
TH-8040	TC-1227	ETE-7730
TH-8041	TC-1228	ETE-7899

Código	Equivalência TC Chicotes	Equivalência Rainha das Sete
TH-8042	nt	nt
TH-8043	nt	ETE-7891
TH-8044	nt	nt
TH-8046	nt	nt
TH-8047	nt	nt
TH-8048	TC-1129	nt
TH-8049	nt	nt
TH-8050	TC-1261	nt
TH-8051	TC-1225	ETE-5008
TH-8052	nt	nt
TH-8053	TC-1134	nt
TH-8054	nt	nt
TH-8056	nt	nt
TH-8057	TC-1031	ETE-7734
TH-8058	TC-1025	ETE-7744
TH-8059	TC-1038	ETE-7885
TH-8061	TC-1043	ETE-7751
TH-8062	TC-1039	ETE-7890
TH-8063	TC-1222	ETE-5057
TH-8065	TC-1120	ETE-7799
TH-8066	TC-1121	ETE-7752
TH-8067	TC-1123	ETE-7789
TH-8068	TC-1125	nt
TH-8069	TC-1092	nt
TH-8070	TC-1074	ETE-7753
TH-8071	nt	ETE-9753
TH-8072	TC-2013	ETE-9794
TH-8074	TC-1013	ETE-7794
TH-8075	TC-1066	nt
TH-8076	TC-1214	ETE-5020
TH-8077	TC-1219	ETE-5052
TH-8078	TC-2031	ETE-9734
TH-8081	TC-1033	ETE-7773
TH-8082	TC-2041	ETE-9888

VEJA TAMBÉM



Espaguete Termo Retrátil
Vide Índice



Conectores

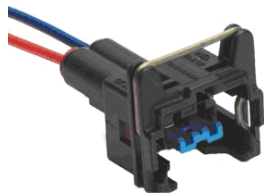

TH-8001

- Chicote para Reparo do Sensor de Temperatura VW/Fiat
- Bico Injetor VW, Fiat e GM
- Sensor de Rotação Uno Mille
- Atuador Marcha Lenta Fiesta 1.0 97 Fiesta, KA 16V Zetec • Sensor Partida a Frio GM • Sensor de Detonação Renault 1.0 16V/Omega GM • Motor de Passo

2 Vias • **Contra-Peça TH-8088**



TH-8002

- Chicote para Reparo Terminal "T"
- Motobomba do Reservatório de Água/Comb.
- Lanterna VW, Ford e GM

2 Vias



TH-8003

- Chicote para Reparo Medidor de Fluxo de Ar Gol GTI, Pointer 95/... Monza MPFI, Escort XR3 • Medidor de Massa Ar Vectra, Omega, Tempra • Conexão do Coletor Admissão Integrado para VW 96/... Tipo IE 93/95 • Outros

5 Vias • **Contra-Peça TH-8064**



TH-8004

- Chicote para Reparo do Sensor de Diagnóstico Uno, Tempra, Palio
- Sensor de Posição da Borboleta TPS
- Bobina da Blazer 4.3
- Sensor MAP Renault 1.0 16V

3 Vias

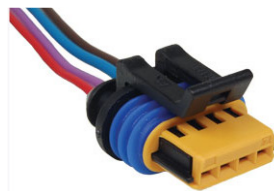

TH-8005

- Chicote para Reparo do Atuador da Marcha Lenta Rochester e Marelli Todos os veículos EFI/MPFI
- Sensor de Fluxo de Massa de Ar Linha GM • Módulo HEI

4 Vias



TH-8006

- Chicote para Reparo do Sensor de Posição da Borboleta TPS Marelli 40415902 / 40380302
- Potenciômetro PF2c/00, 5c/00/6c/00, 1c/00

3 Vias



TH-8007

- Chicote para Reparo da Bobina de Ignição BAE 800 AE Uno, Palio, Tempra com IE Marelli • Bobina Marwal Linha Fiat
- Bobina Visteon B100355
- Farol Dianteiro e Milha do Corsa

2 Vias

• **Contra-Peça TH-2018**



TH-8008

- Chicote para Reparo do Sensor de Temperatura do Ar Linha GM

2 Vias

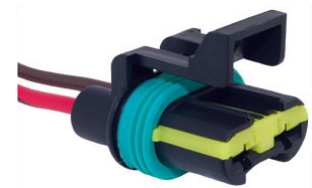

TH-8009

- Chicote para Reparo do Eletroventilador (Ventoinha) Palio 1.5/1.6 e 1.6 16V, Tempra, Weekend
- Linha GM

2 vias

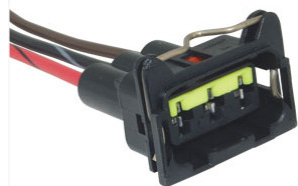

TH-8010

- Chicote para Reparo do Cebolão do Radiador Gol, Saveiro, Parati, Logus (com Ar Condicionado) AP 1.6/1.8/2.0

3 vias

• **Fios 2.5mm**



TH-8011

- Chicote para Reparo do Cebolão do Radiador Gol, Saveiro, Parati, Logus (sem Ar Condicionado) AP 1.6/1.8, Gol, Parati MI 1.0

3 vias (somente 2 funcionam)



TH-8012

- Chicote para Reparo do Eletroventilador (Ventoinha) Gol, Santana

2 vias



Conectores



TH-8013

- Chicote para Reparo do Sensor de Temperatura Monza, Kadett, Ipanema 1.8/2.0, Omega, Suprema 2.2 MPFI, S10, Blazer 2.2 EFI, Corsa MPFI 1.0/1.6
 - Módulo HEI para EFI Gasolina/Álcool
- 2 vias



TH-8014

- Chicote para Reparo do Sensor de Pressão
 - Coletor MAP GM 7120 Kadett, Monza, Ipanema 1.8/2.0 EFI, Corsa Wind 1.4, Pick-up 1.6 EFI, S10, Blazer 2.2 EFI, Omega 2.2
- 3 vias

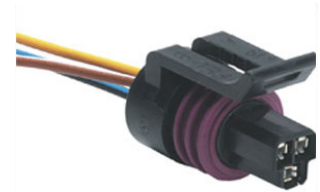

TH-8015

- Chicote para Reparo do Sensor de Posição da Borboleta TPS14059/062 7230/ 7231 - Linha GM EFI/MPFI
 - Outros
- 3 vias



TH-8016

- Chicote para Reparo da Bobina Tipo 1.6, Vectra GSI
 - Sensor MAP Uno Mille ie
 - Sensor de Rotação VW/Ford/Fiat/GM
 - Sensor de Velocidade para VW Linha MI 377957827D
 - Sensor de Temperatura e Potenciômetro 0.280.122.001
- 3 vias
- Contra-peça TH-8093



TH-8017

- Chicote para Reparo do Sensor de Óleo Uno, Tempra, Palio, Corsa, Vectra, Celta
- 1 via



TH-8018

- Chicote para Reparo do Cebolão do Radiador Palio, Tempra, Tipo, Marea
- 3 vias
- Fios 2,5mm



TH-8019

- Chicote para Reparo do Farol de Milha
 - Alto Falante
 - Trava Elétrica Importada
- 2 vias

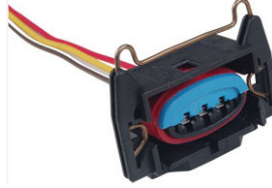

TH-8020

- Chicote para Reparo do Sensor da Borboleta TPS
 - Ignição Fiesta, Courier
- 3 vias

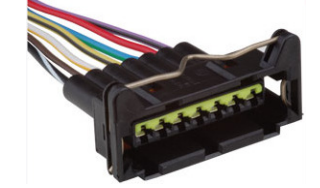

TH-8021

- Chicote para Reparo do Módulo de Ignição
 - Bobina de Ignição
- 7 vias
- Contra-peça TH-8073



TH-8022

- Chicote para Reparo do Farol de Milha (Lâmpada 9005) Linha GM
 - Outros
- 2 vias



TH-8023

- Chicote para Reparo do Farol de Milha (Lâmpada 9006)
 - Farol Baixo S10, Blazer, Silverado
- 2 vias

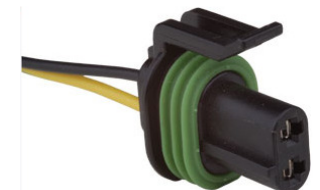

TH-8024

- Chicote para Reparo do Farol de Milha (Trava Lateral) Astra, Vectra 99/...
- 2 vias



TH-8025

- Chicote para Reparo do Eletroventilador (Ventoinha) Kadett, Monza 92 à 96
- 2 vias
- Fios 2,5mm



TH-8026

- Chicote para Reparo do Eletroventilador (Ventoinha) Astra 99/... Blazer, S10, Vectra
- 3 vias



TH-8027

- Chicote para Reparo do Distribuidor do Sistema Hall Linha VW, Fiat, Ford
- 3 vias



Conectores

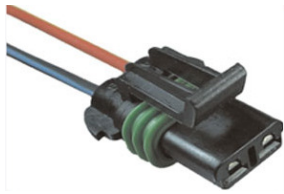

TH-8028

- Chicote para Reparo do Cebolão do Radiador Vectra, Corsa até 2000, Omega 2.2 (sem Ar Condicionado) Palio 1.0, Tempira 96/... (sem Ar Condicionado)
- 2 vias** • **Fios 2,5mm**



TH-8029

- Chicote para Reparo do Canister Linha GM
 - Outros
- 3 vias**

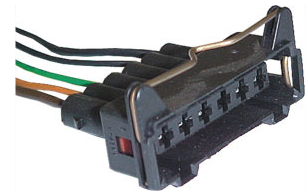

TH-8030

- Chicote para Reparo do Módulo de Ignição Escort
- 6 Vias**



TH-8031

- Chicote para Reparo da Trava Elétrica do Palio
- 6 vias**



TH-8032

- Chicote para reparos diversos



TH-8033

- Chicote para Reparo da Bobina de Ignição Palio, Siena, Brava 1.6, Corsa
- 3 vias**



TH-8035

- Chicote para Reparo do Interruptor de Óleo Monza, Kadett
- 3 vias**



TH-8036

- Chicote para Reparo da Bomba de Combustível Fiesta, Ka, Courier
- 5 vias**



TH-8037

- Chicote para Reparo do Conector Externo da Bomba de Combustível Gol MI, Golf, Passat Importado
- 2 Terminais 6.3mm + 2 Terminais 2.8mm**
4 vias



TH-8038

- Chicote para Reparo, Fio Estanhado Coberto com PVC, Capa de Nylon
 - Aplicação Interna na Bomba de Combustível (Bomba de Combustível Marwal Gasolina)
- 2 vias**



TH-8038-A

- Chicote para Reparo Fio Estanhado Coberto com PVC e Capa Nylon
 - Aplicação Interna Refil da Bomba de Combustível Bosch para Marwal
- 2 vias**



TH-8039

- Chicote para Reparo do Motor do Ar Condicionado S-10 e Blazer
 - Bomba de Combustível Linha GM
- 2 vias**



TH-8040

- Chicote para Reparo do Bico Injetor Corsa, Celta
- 2 vias**



TH-8041

- Chicote para Reparo da Bomba e Tampa de Combustível Corsa, Astra
- 5 vias**



TH-8042

- Sensor MAP Linha GM Final 022/013
- 4 Vias**



Conectores



TH-8043
Conector para vão de motor
1 via

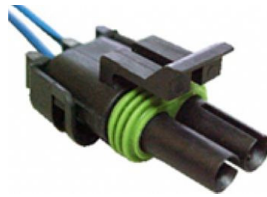

TH-8044
Conector fêmea
2 vias



TH-8046
• Conector para tampa da bomba Peugeot
• Fluxo de ar da linha Fiat
6 vias



TH-8047
• Sensor de temperatura Honda
1 via



TH-8048
• Chicote para Reparo do Sensor de Temperatura Palio, UnoFire 8V, Stilo, Marea
• Bomba D'água do Limpador de Pára-Brisa Renault Clio
2 vias

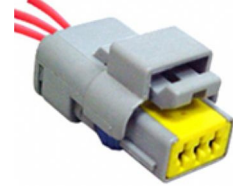

TH-8049
• Sensor temperatura Citroën, Renault, Fiat MTE-4082
3 vias



TH-8050
• Chicote para Reparo de Adaptação da Bomba de Combustível
2 vias



TH-8051
• Bosch GM, Fiat, VW
2 vias



TH-8052
• Conector para adaptação Bomba Bosch para Blazer V6
2 vias



TH-8053
• Chicote para Reparo do Sensor de Rotação Renault Clio 1.0 8 e 16V, Renault Scenic, Peugeot 206 1.0 8 e 16V
2 vias

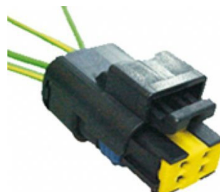

TH-8054
• Sensor Temperatura Fiat MTE 4076 Palio, Siena 1.3 16v, Fire 00/00, Brava 1.6 16v 02/...
4 vias

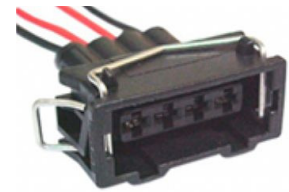

TH-8056
• Sensor Fluxo de Ar Golf GTI – Todos Audi A3 1.8 Turbo
4 vias



TH-8057
Chicote para Reparo do Medidor da Bomba de Combustível Palio 1.0, 1.6 16V, Siena, Weekend • Atuador da Marcha Lenta Uno/Palio/Tempra Magnetti Marelli
• Bobina de Ignição Renault 1.0 16V
4 vias • Contra-peça TH-8078



TH-8058
• Chicote para Reparo do Bico Injetor GM 7560/7561
• Bico Injetor Marelli Single Point
• Sensor de Temperatura do Ar Fiat/VW
• Bico Injetor GM com Motor EFI Rochester
2 vias



TH-8059
• Chicote para Reparo do Sensor de Temperatura VW e Ford
1 via • Contra-peça TH-2038



Conectores



TH-8061

Chicote para Reparo do Eletroventilador (Ventoinha) Santana MI 97/..
Injeção Eletrônica
2 vias



TH-8062

Chicote para Reparo Sensor de Temperatura da Água VW, Ford Zetec
2 vias • Contra-peça TC-2039



TH-8065

• Chicote para Reparo do Farol de Milha/Pisca Dianteiro
• Vidro Elétrico com Motor Bosch Gol GIII, Gol GIV, Fox, Polo, Parati, Golf Todos
2 vias



TH-8066

• Chicote para Reparo do Sensor de Fase
• Sensor de Pressão do Ar Condicionado Gol GIII, Gol GIV, Fox, Polo, Parati, Golf Todos
3 vias • Terminal 1,6mm



TH-8067

• Chicote para Reparo da Sonda Lambda e Bobina de Ignição Gol GIII, Gol GIV, Fox, Polo, Parati, Golf - Todos
4 vias • terminal 2,8mm



TH-8068

• Chicote para Reparo do Corpo da Borboleta Eletrônica Gol GIII, Gol GIV, Fox, Polo, Parati, Golf - Todos
6 vias • terminal 1,6mm



TH-8069

• Chicote para Reparo da Sonda Lambda Vectra 96/98
1 via



TH-8070

• Chicote para Reparo (contra peça) da Sonda Gol MI
4 vias • Contra-Peça TH-8400-K



TH-8071

• Chicote da Sonda Gol MI
4 vias



TH-8072

• Chicote para Reparo Diversos Bulldog (Porta Macho)
4 vias • Contra-Peça TH-8074



TH-8074

• Chicote para Reparo da Bobina de Ignição Tipo 1.6, Corsa
• Sensor Marcha Lenta Astra
• Farol Bifocal Palio 2000
4 Vias • Contra-Peça TH-8072

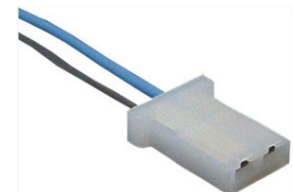

TH-8075

• Chicote para Reparo da Eletroválvula Monza, Kadett, Uno Mille, Caravan, Opala, Bonanza, C-24, C-25, Veraneio
2 vias



TH-8076

• Chicote para Reparo, Fio Estanhado Coberto com PVC, Capa de Nylon
• Aplicação Interna na Bomba de Combustível (Bomba Marwal Álcool)
• Bomba Combustível Bosch 0.580.543.408 / 0.580.453.418 / 0.580.453.481 0.580.453.483
2 vias



TH-8077

• Chicote para Reparo Fio Estanhado Coberto com PVC e Capa de Nylon
• Aplicação Interna Refil da Bomba de Combustível Delphi para Marwal
2 vias



TH-8078

• Chicote para Reparo Superseal (Porta Macho)
4 vias • Contra-Peça TH-8057



Conectores



TH-8079

- Chicote para Reparo da Temperatura do Ar Gol GIII, Gol GIV
- 4 vias**



TH-8081

- Chicote para Reparo do Sensor do Fluxo de Ar Fiesta, Ka, Courier
- 6 vias**

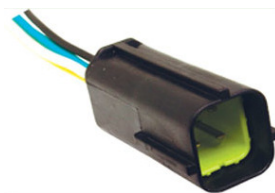

TH-8082

- Chicote para Reparo da Sonda Lambda Brava 1.8 98/... Elba 1.5/1.6 94/.. Tempra 2.0 8v e 16v 94/... Uno 1.0/1.5 1.6 SPI 94/... Mazda 626 2.0 93/95 e 2.5 94/95
- 4 vias**



TH-8083

- Chicote para Reparo do Farol Gol GIII, Gol GIV, Fox, Polo, Parati, Golf Todos.
- 10 vias**



TH-8085

- Chicote para Reparo da Injeção Eletrônica VW, Ford. Sonda do Uno.
- 4 vias**



TH-8089

- Chicote para Reparo da Bomba de Combustível Marwal álcool Monza.
- 2 vias**



TH-8098

- Chicote para Reparo do Bico Injetor Corsa, Celta.
- 2 vias**



Abraçadeiras

Tipo	Código	Medida	9,5mm (Código normal)	14mm (Larga) (Código + L)
Tipo Norma				
	A-8X10	8 X 10	9,5mm (Código normal)	-----
	A-9X11	9 X 11		-----
	A-10X12	10 X 12		-----
	A-11X13	11 X 13		-----
	A-12X14	12 X 14		-----
	A-14X16	14 X 16		-----
Rosca sem Fim				
	A-9X13	9 X 13	9,5mm (Código normal)	-----
	A-12X16	12 X 16		-----
	A-13X19	13 X 19		14mm (Código + L)
	A-14X22	14 X 22		
	A-19X27	19 X 27		
	A-22X32	22 X 32		
	A-25X38	25 X 38		
	A-32X44	32 X 44		
	A-38X51	38 X 51		
	A-44X57	44 X 57		
	A-51X64	51 X 64		
	A-57X70	57 X 70		
	A-64X83	64 X 83		
	A-70X89	70 X 89		
A-76X95	76 X 95	14mm (Código + L)		
A-83X102	83 X 102	-----		
Radial em Inox				
	A-R8,7	Diâmetro: 8,7 mm - Largura: 5mm		
	A-R11,3	Diâmetro: 11,3 mm - Largura: 5mm		
	A-R12,3	Diâmetro: 12,3 mm - Largura: 7mm		
	A-R13,3	Diâmetro: 13,3 mm - Largura: 7mm		
	A-R14,5	Diâmetro: 14,5 mm - Largura: 7mm		
Janela / Coifa				
	A-90,5-7	Diâmetro: 90,5 mm - Largura: 7mm - para Coifa linha Palio	<i>Pentágono</i> 	

Abraçadeira Elástica / Nylon - Preta

FRONTEC®

	Código	Comprimento mm	Ø max amarrão mm	Largura	kgf Ø min amarrão	Aplicação
	AE-10	108,00	22,00	2,50	8,20	Diversas
	AE-20	202,00	51,00	3,70	13,60	Diversas
	AE-30	283,00	76,00	4,80	22,70	Diversas
	AE-40	400,00	114,00	4,80	22,70	Diversas
	AE-40E	398,00	110,00	7,60	54,40	Junta Homocinética





**ROSCA
LARGURA 9 MM**

CÓDIGO
A-9X13S
A-12X16S
A-13X19S
A-14X22S
A-19X27S
A-22X32S
A-25X38S
A-32X44S
A-38X51S
A-44X57S
A-51X64S
A-57X70S
A-64X83S
A-70X89S
A-76X95S
A-83X102S



**ROSCA
LARGURA 14 MM**

CÓDIGO

A-13X19L
A-14X22SL
A-19X27SL
A-22X32SL
A-25X38SL
A-32X44SL
A-38X51SL
A-44X57SL
A-51X64SL
A-57X70SL
A-64X83SL
A-70X89SL
A-76X95SL
A-83X102SL



TIPO NORMA (PARAFUSO G/ PORCA)



CÓDIGO
A-8X10
A-9X11
A-10X12
A-11X13
A-12X14
A-14X16

**RADIAL (INOX)
P/ INJEÇÃO ELETRÔNICA**



CÓDIGO
A-R8,7
A-R11,3
A-R12,3
A-R13,3
A-R14,5

ZIP PARA GOIFAS (INOX)



CÓDIGO
A-ZIP20179 (20,1cm)
A-ZIP36279 (36,2 cm)



Pentágonos
**TIPO JANELA
PARA GOIFA
LINHA PALIO**

CÓDIGO	TAMANHO
A-29,5-7	PEQUENA
A-90,5-7	GRANDE



C-U5



Conector universal 5/16" x 5/16" - Reto
Bartolomeu - Fino (5") - **QC-001** - Pcte 5 pç

C-U5/90



Conector universal 5/16" X 5/16" - 90°
Bartolomeu - Fino (5") - **QC-003** - Pcte 5 pç

C-U7



Conector universal 3/8" x 5/16" - Reto
Bartolomeu -Grosso (7") -**QC-005**-Pcte 5 pç

C-U7/90



Conector universal 3/8" x 5/16" - 90°
Bartolomeu -Grosso (7") -**QC-004** -Pcte 5 pç

QC-013



Conector Bartolomeu 3/8" x 3/8" - Reto

QC-014



Conector Bartolomeu 3/8" x 3/8" - 90°

ACT0039



Conector 5/16" x 5/16" - Reto
Peugeot, Citroën, Renault

ACT0036



Conector 5/16" x 5/16" - 90°
Peugeot, Citroën, Renault

QC-141



Conector 5/16" x 5/16" Reto -4A -Pcte 5 p.

QC-142



Conector 5/16" x 5/16" 90° - 4A -Pcte 5 pç

ACT0067



Conector 5/16" x 5/16" - Reto
Linha GM

ACT0068



Conector 5/16" x 5/16" - 90°
Linha GM

ACT0056



Conector 3/8" x 3/8" - Reto
Linha VW, Toyota, Honda

ACT0081



Conector 5/16" x 5/16" x 4,5

ACT0082



Conector 5/16" x 4,5 - Reto

ACT0083



Conector 5/16" x 4,5 - 90°

QC-151



Conector p/ mangueira da entrada/retorno
da flauta linha Fiat/GM **RETO** -cinza-DSC5081

QC-152



Conector p/ mangueira da entrada/retorno
da flauta linha Fiat/GM **90°** - cinza - DSC5082

ACT0048



GRANDE
Conector de fechamento flauta 12 x 6 - 90°
Renault Clio, Twingo, Kangoo
Flautas 7.700.108.667 / 7.700.114.546

ACT0057



PEQUENO
Conector de fechamento flauta 6 x 5 - 90°
Renault Clio 1.1 8V, Kangoo, Megane /05
Flautas 7.700.273.495 / 7.700.108.667

DSC 2065



Conector p/ mangueira da flauta
Motor Endura: Gas, Fiesta, Courier - **PAR**

QC-009



Conector 5/16" x 5/16" - Reto
STR Vapor

QC-028



Conector 5/16" x 5/16" - 90°
STR Vapor

QC-022



Conector 45° - Pop Top
5/16" x 5/16"

ACT0060



Conector em T
5/16" x 5/16" x 5/16"

QC-106



Conector em T - Pop Top
3/8" x 5/16" x 5/16"

QC-040



Conector em Y 45° - Pop Top
5/16" x 5/16" x 5/16"

QC-096



Conector em Y - Pop Top
5/16" x 5/16" x 5/16"



DV-483



Adaptador 5/16" x 5/16" - Reto
Corrugado / Corrugado

ADP0027



Adaptador 3/8" x 3/8" - Reto
Corrugado / Corrugado

DV-496



Adaptador 5/16" x 5/16" - Reto
Liso / Corrugado

DV-528



Adaptador 3/8" x 5/16" - Reto
Liso / Corrugado

DV-531



Adaptador 5/16" x 5/16" - 90°
Liso / Corrugado

DV-608



Adaptador 5/16" x 5/16" X 5/16" - em T
Corrugado / Liso / Liso

DV-1118



Adaptador 5/16" x 5/16" X 5/16" - em T
Corrugado / Corrugado / Liso

ADP0019



Adaptador 5/16" x 5/16" X 5/16" - em T
Corrugado / Corrugado / Corrugado

ACT0080



Conector 5/16" em Y
Partida à frio linha Renault

NV-029



Conexão "T" gasolina/alcool
Grande - Pcte 10 pç

NV-129



Conexão "T" carvão ativado VW 94/
Pequeno - Pcte 10 pç

NV-191



Conexão em "Y" para mangueira
Gol, Voyage, Parati, Saveiro - Pcte 10 pç

NV-432



Conexão reta
Emenda mang. para-brisa etc - Pcte 10 pç

NV-022



Guia vareta do óleo - Pcte 5 pç
Gol, Saveiro, Santana etc - Todos AP

NV-298



Guia vareta do óleo
Gol G5, Fox, Polo, Golf

ASF0063



Prolongador de Bico Injetor
Linha VW - Bicos Nº IWP176 - DSC2305

ASF0065



Prolongador de Bico Injetor
Linha VW - Bicos Nº IWP170 - DSC2304

ASF0093



Trava Metálica de Bico Injetor
Sistema M. Marelli - DSC2340 - Pcte 4 Pç

ASF0131



Trava Metálica de Bico Injetor
Sistema Bosch - DSC2341 - Pcte 4 Pç



TB-1775

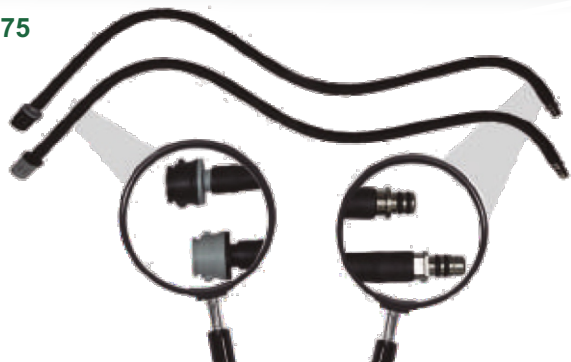

Palio 1.0 / 1.5 8V MPFI 97/01 - Exceto Fire
AMC0024

TB-1776

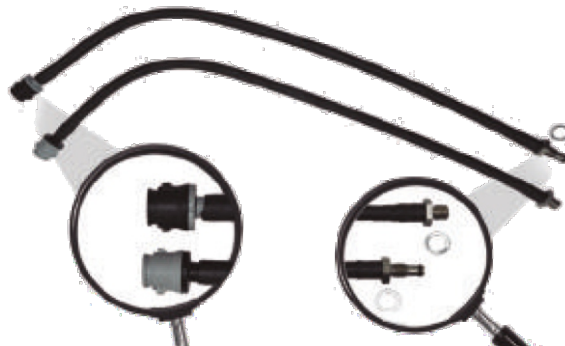

Palio 1.0 8V 96/01. Palio 1.6 16V 96/00, Palio Weekend 1.0 8V 99/00
Siena 1.0 8V 99/00, Siena 1.6 16V 98/00, Siena Fase I 03-04/... Strada 16V 96/01
AMC0023

TB-1777

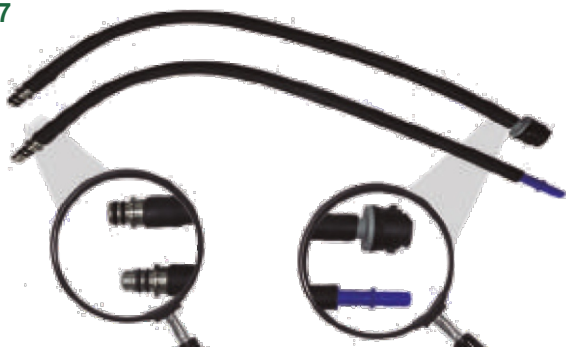

Fiorino 1.5, Palio 1.6 8V, Fiorino Bau 1.5 8V 97/...
Fiorino Pickup 1.5 97/02, Mille 99/01 MPFI - AMC0025

AMC0022



Palio 1.0 / 1.3 / 1.5 8V 96

TB-1898

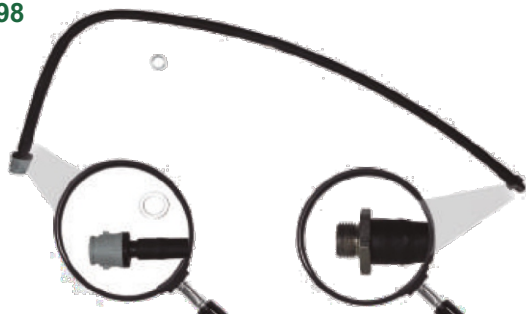

Palio, Brava 1.6 16v
AMC0026

AMC0028



Palio, Siena Motor Fire 8V 1.0 / 1.3 Fase I e II

AMC0029



Uno, Fiorino 1.0 / 1.3 8V
Fiorino 03, Mille 1.3 02, Uno 1.3 8V - Todos Fire

Citroen C3, C4 1.4 e 1.6 00/14
Peugeot 307, 206, 207 1.4 00/14
Código Original : 1323.12



AMC0080



Peugeot 206, 207 1.4 8v 1.6 16v Hoggar todos
Citroen C3 1.4 e 1.6 8v/16v até 2012
Código Original : 1323.Y2



AMC0081



Citroen C4 (todos) 1.6 16v
Peugeot 307/308 motor 1.6 16v
Código Original : 1323.A5



AMC0082



Citroen C3 03/10
Código Original : 1323.V4



AMC0083



Citroen Picasso 1.6 16v
Código Original : 1307.ZV

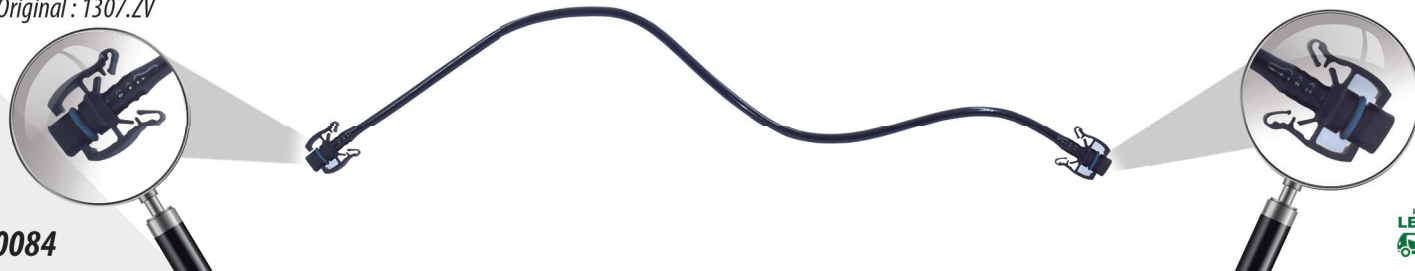

AMC0084



M-13,5



MANGUEIRA INJECAO 3,5X8MM (1/8) -
PRETA - IBTF - ROLO 25M

M-15



MANGUEIRA INJECAO 5X10MM (3/16) -
PRETA - IBTF - ROLO 25M

M-17



MANGUEIRA INJECAO 7X13MM (9/32) -
PRETA - IBTF - ROLO 25M

M-18



MANGUEIRA INJECAO 8X14MM (5/16)
PRETA - IBTF - ROLO 25M

M-19



MANGUEIRA INJECAO 9X15MM (11/32)
PRETA - IBTF - ROLO 25M

M-15A



MANGUEIRA INJECAO 5X10MM (3/16)
AZUL - IBTF - ROLO 25M

M-17A



MANGUEIRA INJECAO 7X13MM (9/32)
AZUL - IBTF - ROLO 25M

M-18A



MANGUEIRA INJECAO 8X14MM (5/16)
AZUL - IBTF - ROLO 25M

M-19A



MANGUEIRA INJECAO 9X15MM (11/32)
AZUL - IBTF - ROLO 25M

M-C3,5



MANGUEIRA CRISTAL 3,5MM (AVANCO)
ROLO 50M

M-C5



**M-C5S
(SILICONADA)**



MANGUEIRA CRISTAL 5MM (GASOLINA)
ROLO 50M

M-C7



MANGUEIRA CRISTAL 7MM (1/4 X 2,5MM)
ROLO 50M

M-CB



MANGUEIRA RESPIRO BRASILIA
3/8 X 1,5 - ROLO 25/50M

M-CVW



MANGUEIRA RESPIRO VW PLASTICA
CRISTAL 1/2 X 1,5 - ROLO 25/50M

M-CM



MANGUEIRA CAPA-MOLA 5/8 X 1,5
CRISTAL - ROLO 25/50M

M-CML



MANGUEIRA CAPA-MOLA 1/2 X 1,5
LEITOSA - ROLO 25/50M

M-CML5/8



MANGUEIRA CAPA-MOLA 5/8 X 1,5
LEITOSA - ROLO 25/50M

M-EA



MANGUEIRA ESGUICHO D'AGUA - 4X10
ROLO 50M

M-EB



MANGUEIRA AVANÇO 4X2 MM - NYLON
ESPAGUETE - ROLO 50 M

M-L3,5



MANGUEIRA LONADA 3,5 X 7,5MM
IBTF - ROLO 25M

M-L5,0



MANGUEIRA LONADA 5 X 9MM (13/64)
IBTF - ROLO 25M

M-L7,0



MANGUEIRA LONADA 7 X 11MM (9X32)
IBTF - ROLO 25M

M-L9,0



MANGUEIRA LONADA 9 X 13 MM (23/64)
IBTF - ROLO 25M

M-L12



MANGUEIRA LONADA 12 X 17MM (15/32)
IBTF - ROLO 25M

M-T6

(6 mm)



M-T8

(8 mm)

M-T10

(10 mm)



M-T12

(12 mm)

M-H10



MANGUEIRA TECALON/NYLON (TANQUE)
ROLO 50M

MANGUEIRA TECALON/NYLON (TANQUE)
ROLO 25M

MANGUEIRA HIDROVÁCUO 9,5X17,5 MM -
LINHA FIAT / GM - IBTF - ROLO 25M

M-H12



MANGUEIRA HIDROVÁCUO 12,0X20,0 MM
LINHA VW / FORD - IBTF - ROLO 25M



Mangueiras



Lonada, Injeção Eletrônica e Hidrovácuo

Código	Descrição	Ø Interno mm	Cor	Embalagem
M-L3,5	Lonada	3,5	Preta	25 metros
M-L5		5,0	Preta	
M-L7		7,0	Preta	
M-L9		9,0	Preta	
M-L12		12,0	Preta	
M-I3,5	Injeção	3,5	Preta	
M-I5		5,0	Preta	
M-I7		7,0	Preta	
M-I7A		7,0	Azul	
M-I8		8,0	Preta	
M-I8A		8,0	Azul	
M-I9		9,0	Preta	
M-I9A		9,0	Azul	
M-H10	Hidrovácuo	9,5	Preta	
M-H12		12,0	Preta	



Cristal, Tecalon e Diversas



Código	Descrição
M-C3,5	Cristal 3,5 mm (1/8" x 1,5mm) - Avanço - (emb. 50 m)
M-C5	Cristal 5 mm (5mm x 2,5mm) - Gasolina - (emb. 50 m)
M-C7	Cristal 7 mm (1/4" x 1,5mm) - Bico Grosso Gasolina - (emb. 50 m)
M-CVW	Respiro Volks Cristal 12mm (1/2" x 1,5mm) (emb. 25 m)
M-CB	Respiro Brasília Cristal 10mm (3/8" x 1,5mm) (emb. 25 m)
M-CM	Capa-Mola Cristal 5/8" x 1,5mm (emb. 25 m)
M-CML5/8	Capa-Mola Leitosa 5/8" x 1,5mm (emb. 25 m)
M-CML	Capa-Mola Leitosa 1/2" x 1,5mm (emb. 25 m)
M-T6	Tecalon Preta 6 mm - Tanque - (emb. 50 m)
M-T8	Tecalon Preta 8 mm - Tanque - (emb. 50 m)
M-EB	Espaguete Branca - Avanço - (emb. 50 m)
M-EA	Mangueira do Esguicho D'água Para-brisa 4mm x 1,mm - Preta - (emb. 50 m)
M-CO	Corrugada para Bomba de Combustível (250mm) - Unitária



46.448.515

TR-504



Palio 96/02 1.0 8V (duas saídas)

46.467.381

TR-507



Palio,, Siena 1.5 96/04
Strada 99/04 1.5 8V (saída menor)

46.478.774

TR-516



Palio, Weekend, Siena, Strada 1.6 8/16V 98/00
Siena 99/00 e 03/04 SPI

46.535.628

TR-505



Palio 1.5 96/04 (saída larga).

46.539.451

TR-509



Palio 96/00 Weekend, Siena, Strada 1.6 16V

46.789.767

TR-511



Palio, Siena, /03 1.0 16V, Siena 04/08 1.3 8V
Palio, Siena, Strada, 09/... 1.4 8V
Palio 05/07 1.3 16V

46.789.769

TR-520



Palio 01/07, Siena 02/07 1.0/1.3
Weekend 01/03 (1.0/1.3 16V MPFI)

46.798.703

TR-508



Palio, Weekend, Siena 01/03 1.6 16V

50.017.371

TR-503



Uno Mille 02/06 1.0 8V e Fiorino 1.3

50.017.372

TR-510



Palio, Uno Fire 1.0/1.3 8V 01/...

500.014.769G

TR-519



Fiorino, Uno 97/04 1.5 8V e 01/03 1.3 8V
com bocal maior

500.014.769P

TR-518



Fiorino, Uno 97/04 1.5 8V e 01/03 1.3 8V
com bocal menor

51.712.916

TR-512



Palio, Siena 1.0 Fire 8V 04/06

51.745.868

TR-502



Palio 1.4 8V, Idea 1.4 8V 06/... Fire

55.180.198

TR-501



Uno 01/03, Siena 01/03 1.0 8V
Palio 01/03 (serve p/ alguns tipos de Fire)

55.210.055

TR-506



Palio Fire 1.0 e 1.4 09/...

7.524.713

TR-517



Uno, Elba, Premio 1.5 8V 91/96
Fiorino 1.5 8V 89/96 (sem bocal)

90.411.727

TR-553



Corsa 02/... Celta 01/... (com sensor)

90.466.213

TR-552



Corsa 02/... Celta 01/... (com bocal)

93.396.087

TR-551



Corsa 02/... Celta 01/... (sem bocal)

93.240.117

TR-554



Vectra 97/05 2.0/2.2 MPFI 8V

93.362.610

TR-555



Corsa 02/ Montana 04/10

94.701.921

TR-556



Celta, Prisma, Corsa Classic 09/... 1.0

94.701.922

TR-557



Prisma 1.4 09/... (bocal maior)



Tampas



Tampas do Reservatório de Expansão



M-58 - MIW 1,5 bar
20618 - Unick
 VW: Gol, Voyage, Parati, Saveiro 87/99, Santana, Pointer, Logus, Apollo, Kombi Diesel
 Ford: com motor 90/... AP
 Audi: A4 .../96 Chassi T 309402, A6 .../96, A8



10337 - Unick 1,5 bar
 VW: Golf .../97, Passat .../96 Gol, Parati, Saveiro 00/... Polo, Van, Eurovan, Caravelle
 Seat: Córdoba, Ibiza



M-63C - MIW 1,0 bar
10295 - Unick
 Fiat: Palio, Uno, Siena 00/... Fire



M-63B - MIW 1,4 bar
10296 - Unick
 Fiat: Brava, Marea, Marea Week



60778 - Unick 1 bar
 Fiat: Palio, Prêmio, Elba, Tempra, Tipo .../00



M-63 - MIW 1 bar
60779 - Unick
 Fiat: Uno, Tempra, Tipo, Palio, Siena, Pick-up .../2000, Ducato



M-80 - MIW 1,2 bar
30460 - Unick
 Ford: Fiesta 95/..., Escort 97/... Ka, Fiesta, Courier



M-62 - MIW 1,5 bar
40192 - Unick
 GM: Monza todos, Kadett, Omega, Vectra, Corsa, Chevette, Marajó 87/... Troller: todos



10346 - Unick 1,4 bar
 GM: Astra, Vectra, Corsa todos, Celta todos, Meriva, Zafira



10316 - Unick 1,2 bar
 Renault: Clio Hatch, Sedan 99/03, Mégane, Scénic, Twingo, Laguna, 19, 21, Trafic Express



10388 - Unick 1,2 bar
 Citroën: C3/C5/C8, Picasso
 Peugeot: 206, 307, 406

Tampas do Radiador



M-43 - MIW 13 libras
20458 - Unick
 VW: Passat, Gol, Voyage, Parati, Saveiro 74/86



M-44 - MIW 13 libras
30291 - Unick
 GM: Opala, Caravan, Chevette, Chevy, Marajó .../84
 Ford: Escort, Verona



M-56 - MIW 15 libras
40465 - Unick
 GM: Opala, Caravan 85 à 92, S10, Silverado



M-50 - MIW Selada
30293 - Unick
 Bomba d'água
 Ford: Escort, Pampa .../92, Verona
 VW: todos c/ motor CHT
 GM: Chevette 85/...



M-64 - MIW Selada
30418 - Unick
 Ford: Del Rey, Corcel, Belina, Pampa



M-49 - MIW 15 libras
60726 - Unick
 Fiat: 147, Panorama, Oggi, Spazio, Elba - utilitários .../88





Tampas



Tampas do Óleo do Motor



10272 - Unick
VW: Gol, Voyage, Passat, Kombi, Santana
GM: Monza
Caminhões: Scania e MB .../90



M-52 - MIW
20368 - Unick
VW: Sedan, Brasília, Kombi, Gol



M-57PL - MIW
20512 - Unick
VW: Gol, Passat, Santana, Parati
Ford: AP



M-79 - MIW
20829 - Unick
VW: Passat, Variant
GM: S10 - motor Maxion
Toyota: Utilitários MB: Sprinter
Troller: Todos



10275 - Unick
GM: Chevette, Opala 78/...



M-84 - MIW
40332 - Unick
GM: Monza, Kadett, Omega, Ipanema, Corsa, S10, Vectra Original Amarela



40501 - Unick
GM: Chevette, Opala 79/...



M-59 - MIW
GM: Chevette, Opala, A-10, C-10 - 100% Borracha Nitrílica



10309 - Unick
GM: Astra, Vectra 97/... 16V



10307 - Unick
GM: Corsa, Tigrá 1.0/1.6 16V



10308 - Unick
GM: Astra 8V, Vectra, S10, Blazer



10311 - Unick
GM: Corsa, Celta 01/... 8V



10273 - Unick
Ford: Corcel todos



M-68 - MIW
Ford /VW: todos CHT

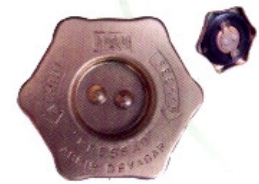

M-72 - MIW
60735 - Unick
Fiat: 147, Uno, Tempra 8V



10280 - Unick
Fiat: Palio, Weedkend, Siena



10302 - Unick
Fiat: Uno, Palio, Siena - Fire 8V



10303 - Unick
Fiat: Uno, Premio, Fiorino 1.5/1.6



10304 - Unick
Fiat: Tempra, Tipo, Palio 16V



10306 - Unick
Fiat: Fiorino, Pick-up, Brava, Marea, Tipo .../97

Tampas do Reservatório do Fluido de Freio



10334 - Unick
Linha: VW - todos



10285 - Unick
VW: Sedan, Kombi
Ford: Corcel GM: Opala





Tampas



Tampas do Reservatório de Água do Para-brisa



10289 - Unick
Linha: VW 95/...



10287 - Unick
Linha: Fiat e Ford



10290 - Unick
Ford: Ka, Fiesta, Courier

Tampas do Reservatório de Gasolina



10390 - Unick
VW: Polo, Fox 05/...

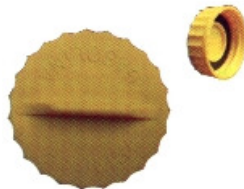

M-70 - MIW
20375 - Unick
VW: motor a álcool



M-69 - MIW
Ford: Escort, Verona
(todos com motor a álcool)



Tampa do Reservatório de Expansão do Radiador



1,5 bar

E-0501

Similar Unick 20618 / MIW M-58

VW: Gol, Voyage, Parati, Saveiro 87/99
Santana, Pointer, Logus - Todos AP
Ford: Todos Motor AP 90/...
Cod. Original: 377.131.321-A



1,5 bar

E-0525

Similar Unick 40192 / MIW M-62

GM: Monza, Kadett, Omega, Vectra
Corsa, Chevette, Marajo 87/ S-10
Ford: Fiesta, Courier 10-02/
Ka 08/ Ecosport 03/
Cod. Original: 93.220.885



1,0 bar

E-0508

Similar Unick 60779 / MIW M-63

Fiat: Uno, Palio 96/00 e Young 00/02
Siena 98/00 Weekend 97/00
Strada 99/2002 Tempra, Tipo
Cod. Original: 46.402.982



1,4 bar

E-0510

Similar Unick 10296 / MIW M-63B

Fiat: Palio, Weekend, Siena Fire 96/
Strada Fire 98/ Marea, Brava 99/...
Cod. Original: 46.457.390

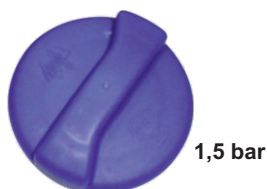

1,5 bar

E-0516

Similar Unick 10315

VW: Gol, Voyage, Saveiro GV, New Beetle
Fox, Golf 98/... Jetta 06/... Bora 05/...
Polo 05-02/, Kombi 1.4 Flex 06 / 05-07
Audi: A3, A4 e A6 97/
Cod. Original: 1JO.121.321-B



1,5 bar

E-0569

Similar Unick 10337

VW: Gol, Voyage, Saveiro GIV 00/08
Golf 94/97, Polo .../02 Van, Eurovan
Seat: Cordoba, Ibiza 95/03
Cod. Original: 357.121.321C 1H0.121.321C



1,4 bar

E-0512

Similar Unick 10346

GM: Astra, Vectra,
Corsa todos, Celta todos,
Meriva, Zafira
Cod. Original: 93.220.885



1,5 bar

E-0515

Similar Unick 10388

Citroën: C3, C4 Pallas
C5, C8, Picasso
Peugeot: 206, 307, 406
Cod. Original: 1306.E4 / J5

Tampa do Tanque de Combustível c/ Chave



E-0541

Similar Unick 10201

VW: Gol, Voyage, Parati,
Saveiro 87/89
Cod. Original: 307.201.551.14



E-0539

Similar Unick 10358

VW: Gol GII à GV, Fox
Santana 87/ Golf, Polo, A3
GM: Monza, Kadett 90/...
Cod. Original: 307.201.551



E-0542

Similar Unick 10211

VW: Gol GII à GV, Fox
Santana 87/ Golf, Polo, A3
GM: Monza, Kadett 90/...
Cod. Original: 307.201.551B



E-0521

Similar Unick 10235

Uno 95/04, Fiorino, Premio, Elba
Cod. Original: 7.519.099



E-0522

Similar Unick 10240

Palio .../04
Cod. Original: 7.797.698

Tampa do Reservatório de Gasolina



E-0523

Similar Unick 10378

GM: Monza, Kadett, Corsa,
Celta, Prisma, Vectra e S10 06/
Omega, Astra 05/ Zafira 01/



E-0524

Similar Unick 10489

Ford: Fiesta 04/ Ka 08/
Ecosport 1.6 05/ Courier /07

Tampas de Combustível



10200
Brasília .../77, SP1, SP2 72/...
Variant II todos
Santana, Quantum .../89
Topic, Traffic 94/...
c/ chave - ventilada
Cod. Original: ZBA-201.551



10202
VW Sedan 1300, 1600
Brasília 78/...
c/ chave - c/ rosca - vedada
Cod. Original: 113.201.551.4



10203
Gol, Saveiro .../89
Voyage, Parati .../86
Kombi Clipper 09-81/89
c/ chave - gasolina - ventilada
Cod. Original: 305.201.551.10



10207
Fusca .../77, Kombi 08/81,
TL, Variant .../71, Karmann Guia TC
67/... Karmann Guia KG .../71, Corcel
.../72 Galaxy, Landau .../71
Utilitários GM
Alfa-Romeo 2300 todos
Toyota Bandeirantes todos .../94
c/ chave - ventilada
Cod. Original: BD1A-9W030-A



10210
Sedan 1200, 1300, 1500 .../77 Variant,
TL, Corcel II, Del Rey todos,
F-1000, F-4000, Opala, Chevette,
Marajó, Monza, Chevy, Bonanza,
Veraneio, A/C/D-10, A/C/D- 20 .../89
c/ chave - ventilada
Cod. Original: 94.622.397/8



10211
Gol GII, GIII, GIV,
Voyage, Parati 87/... Golf 91/...
Santana, Quantum/ 90/...
Polo, Saveiro 97/...
Fox 03/... Passat importado
Versailles 91/... Samara todos
c/ chave - c/ rosca valvulada
Cod. Original: 05.201.551.10
191.201.551-A/ 305.201.551.19



10224
Premio, Elba, Utilitários 83/90
c/ chave - ventilada
Cod. Original: 4.358.241



10225
Premio, Elba, Utilitários 90/...
c/ chave - ventilada
Cod. Original: 7.519.099



10228
Pointer 94/96, Logus 93
Escort 93/96, Verona
c/ chave - vedada
Cod. Original: 547.201.551



10229
Vectra 96/... Omega 99/...
Astra, Blazer, Silverado 97/... Celta,
Corsa Zafira, Meriva, Montana - Tds
c/ chave - cinza - vedada
Cod. Original: 93.224.461



10233
Kombi 90/05-97
Gol, Saveiro 90/96
c/ chave - valvulada
Cod. Original: 305.201.551.15



10235
Uno 95/2004
c/ chave - ventilada
Cod. Original: 7.519.099



10240
Palio .../04
c/ chave - vedada
Cod. Original: 7.797.698



10241
Fiesta, Ka, Courier
com chave
Cod. Original: 96FB-9K163-DA



10243
Kombi Clipper 06-97/...
c/ chave - valvulada - gasolina
Cod. Original: 237.201.551.1



10244
Kombi Clipper 06-97/...
c/ chave - s/ válvula - álcool
Cod. Original: 237.201.551.2



10262
Monza, Chevette .../88
Opala 85/89
c/ chave - vedada
Cod. Original: 94.652.563



10279
Logan, Sandero, Master, Clio
Hatch/Sedan 99/...
c/ chave - vedada
Cod. Original: 7701471585/
600155110



10350
Escort Zetec 97/... Todos
Cod. Original: 97AG.9K163CA



10379
Uno 04/...
com chave - original
Cod. Original: 517.30.9150



Reservatórios

Partida a Frio



NV-225
Kit Reservatório partida a frio com tampa, suporte metálico e vedador da bomba
Capacidade: 700ml



NV-195
Kit Reservatório partida a frio com tampa, suporte metálico e vedador da bomba
Capacidade: 1500ml



NV-225A
1 - Kit Reservatório partida a frio 700ml (NV-225)
1 - Bomba
1 - Botão Start
1m - Mangueira Lonada 5mm
2m - Fio Cabinho 1,0mm
2 - Terminal de Fio Fêmea sem Trava 6.3
1 - Engate Rápido fio / Bomba



NV-225B
1 - Kit Reservatório partida a frio (700ml) (NV-225)
1 - Bomba
1 - Botão Start
1m - Mangueira Lonada 5mm
2m - Fio Cabinho 1,0mm
2 - Terminal de Fio Fêmea sem Trava 6.3
1 - Engate Rápido fio / Bomba
1 - Válvula Solenóide 2 vias
1 - Conector/Chicote 2 vias para válvula



NV-409A
1 - Kit Reservatório partida a frio Monza 82/...
1 - Eletro Bomba
1 - Botão Start
1m - Mangueira Lonada 5mm
2m - Fio Cabinho 1,0mm
2 - Terminal de Fio Fêmea sem Trava 6.3
1 - Engate Rápido p/ terminal de fio/ Eletro Bomba



NV-409
Reservatório partida a frio
GM: Monza 82/...
Nº Original: 93.201.871



377.201.085.1
Reservatório partida a frio
VW: Santana, Quantum 84/95 Todos
Nº Original: 377.201.085.1



NV-225GM
Kit Completo
Acompanha Bomba e Mangueira
GM: Classic, Celta, Prisma
Nº Original: 093 341 731

Expansão



NV-009
VW: Gol, Parati, Saveiro, Voyage .../87
Nº Original: 303.121.401.1

Limpador do para-brisa



K65431
VW: Gol 96/...
Nº Original: 377.955.453 A



Desborbulhador



2055
Separador de Vapor - Desborbulhador
Ford, GM



2056
Separador de Vapor - Desborbulhador
VW, Fiat

Kit Vedação Bomba de Água



KB-6007
Kit Vedação da Bomba da água (dedal)
Acompanha Abraçadeira
Motor CHT



KB-6008
Kit Vedação da Bomba da água (dedal)
Acompanha Abraçadeira
Motor do Monza





Carcça da Válvula Termostática

RHOPEM

Produto com
Qualidade Nacional



EM ALUMÍNIO



SISTEMA PARA
COTOVELO DA
VÁLVULA
TERMOSTÁTICA COM
PRISIONEIROS.

LANÇAMENTO

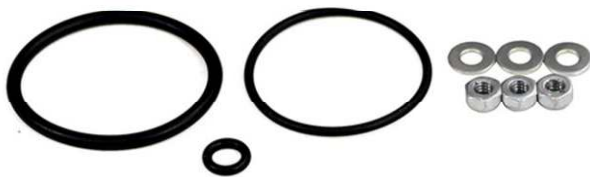

RH 023

Fiesta, Ka, Courier
1.0/1.6 8V 99/...

Ecosport 1.0/1.6 8V 03/12

Focus 1.6 8V 01/08

Todos Motor Zetec Rocam

Carcça da Bomba da Água



RH 017

Uno todos 78/02

Kit Universal



RH 009

Todos Motor AP

Bombas de Combustível Carburados

RHOPEM



RH001 - RHOPEM
YMAX0261 - YMAX
IG9160 - IGNIFORT

VW: 1300, 1500, 1600
Álcool e Gasolina
Similares - Brosol: 214131 / **Carter:** 60262

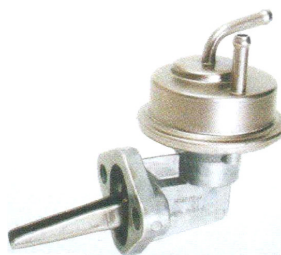

RH002 - RHOPEM
YMAX0442 - YMAX
IG9151 - IGNIFORT

VW: Passat, Voyage, Parati, Saveiro, Gol Arrecimento à água 1.5 e 1.6 89/91, Apollo, Santana Quantum 1.8/2.0
Ford: Del Rey, Pampa, Escort, Verona 1.8 .../91
Álcool e Gasolina
Similares - Brosol: 226510



RH003 - RHOPEM
YMAX0209 - YMAX
IG9140 - IGNIFORT

Ford: Belina, Corcel I / II
Álcool e Gasolina
Similares - Brosol: 251510 / **Carter:** 60211



RH004 - RHOPEM
YMAX0279 - YMAX
IG9148 - IGNIFORT

VW/ Ford: Todos Motor CHT
Álcool e Gasolina
Similares - Brosol: 251091 / **Carter:** 60276



RH005 - RHOPEM
YMAX0461 - YMAX
IG9156 - IGNIFORT

VW/ Ford: Todos Motor AP
Álcool e Gasolina
Similares - Brosol: 216910
Carter: 60442



RH006 - RHOPEM
YMAX0338 - YMAX
IG5001 - IGNIFORT

Fiat: 147 1050 todos, Spazio, Panorama, Pick-up, Furgão, Uno, Fiorino, Elba, Prêmio motor 1300 todos, Pick-up Fiorino, Furgão motor 1500 todos Uno Mille/ Eletronic
Lada: Niva, Laika, Samara - Todos
Álcool e Gasolina
Similares - Brosol: 281300 / **Carter:** 60339



RH007 - RHOPEM
IG5023 - IGNIFORT
YMAX0368 - YMAX

GM: Monza, Kadett, Ipanema .../91
Álcool e Gasolina
Similares - Brosol: 243141 / **Carter:** 60369

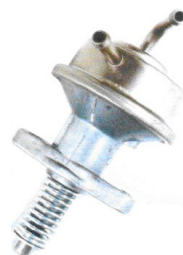

RH008 - RHOPEM
IG5021 - IGNIFORT
YMAX6782

GM: Chevette Jr. Todos, Chevette Sedan/ Hatch, Chevy 500, Marajó todos motor 1400/ 1600 - Álcool e Gasolina
Similares - Brosol: 243122 / **Carter:** 6783



YMAX6969 - YMAX
GM: Opala 4/6 CC - Antigo
Sistema Rosca



YMAX0347 - YMAX
GM: Opala 4/6 CC - Moderno
Sistema Mangueira



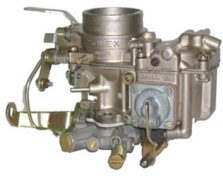

Reparos de Carburador



Carburadores Modelo Weber

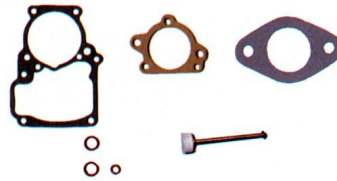

Krater: 01.15032/S
Autolex: 200.032
Opala, Caravan 4 cil. - gasolina
Carb. 22.022/023

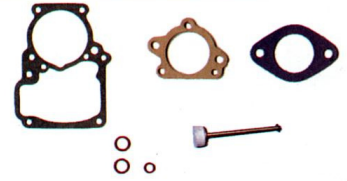

Krater: 01.15047/S
Autolex: 200.047
Chevette 1.4 - gasolina. 73/81

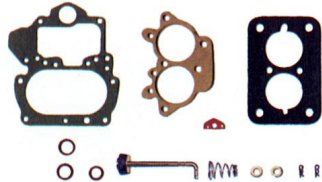

Krater: 01.15065
Autolex: 200.065
Opala, Caravan 4 e 6 cil. - álcool
Carb. 466.065 73

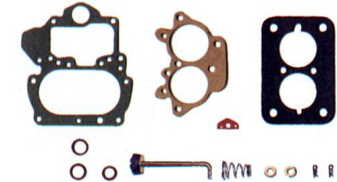

Krater: 01.15066
Autolex: 200.066
Opala, Caravan 4 e 6 cil. - gasolina
Carb. 446.065

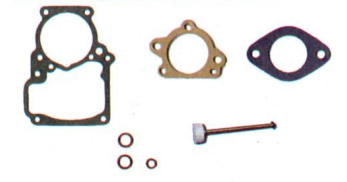

Krater: 01.15107/S
Autolex: 200.107
Corcel, Belina - gasolina
Carb. 228.104/107

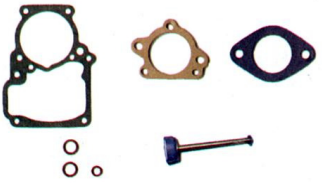

Krater: 01.15116/S
Autolex: 200.116
Corcel, Belina - álcool 80/ 83
Carb. 228.113 / 114 / 115 / 116

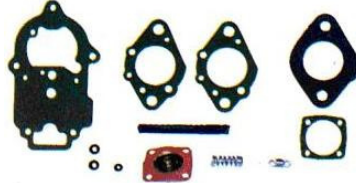

Krater: 33.15190/B/S
Autolex: 200.190
147, Uno 1300, Monza 1.6/1.8
Carb. 190.001

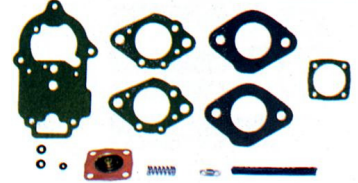

Krater: 33.15191/B/S
Autolex: 200.191
Uno Mille, Pick-Up, Fiorino - gasolina 89 à 91

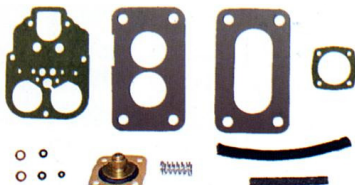

Krater: 33.15450
Autolex: 200.451
Passat, Gol, Voyage, Parati 1.6 83 - gasolina
Carb. 450 / 40 / 4061

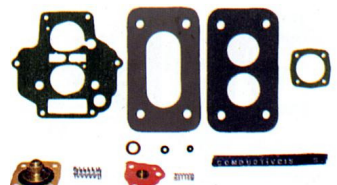

Krater: 33.15460/S
Autolex: 200.460
Ford CHT - Corcel, Belina, Escort, Chevette

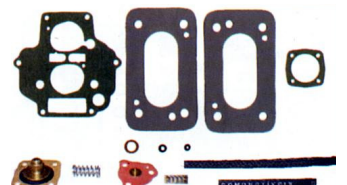

Krater: 33.15461/S
Autolex: 200.461
Fiat 1300 SX, 1500 todos
Carb. 460

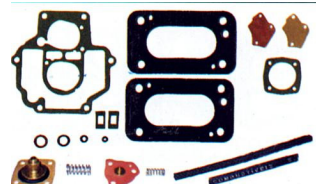

Krater: 33.15462/S
Autolex: 200.462
Tempra 2.0 92 - gasolina

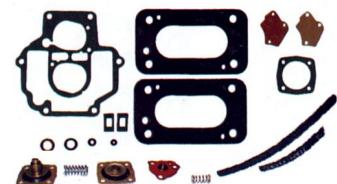

Krater: 01.15463
Autolex: 200.463
Tempra 2.0 93 - álcool

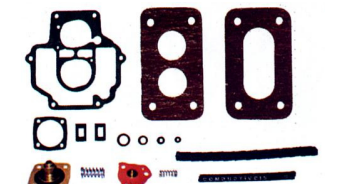

Krater: 33.15460/M
Autolex: 200.464
Gol 1.0, Parati, Voyage 89 - álcool/ gasolina

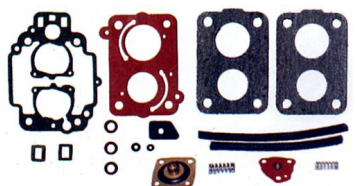

Krater: 33.15495/VM/S
Autolex: 200.495
Gol, Voyage, Parati 89, Fiat 1.6, Escort
TLZD - álcool

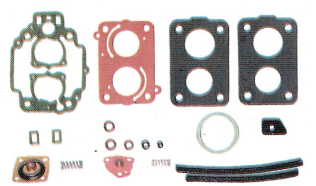

Krater: 33.15498/VM
Autolex: 200.495/1
Gol, Voyage, Saveiro, Parati 89 - álcool/ gasolina
TLDE

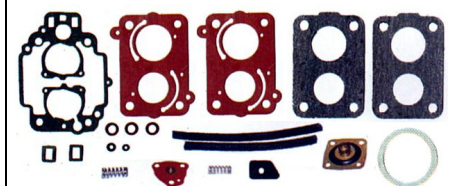

Autolex: 200.495/2
Logus, Apollo, Escort, XR3, Verona
Motor Transversal (495 E) Carb. Eletrônico



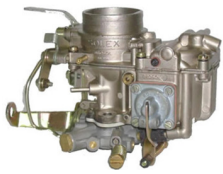

Reparos de Carburador

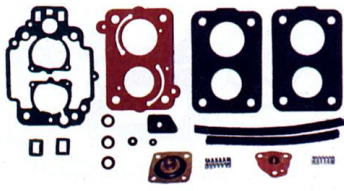

Krater: 33.15495/F/VM
Autolex: 200.496
Fiat 1.6/1.8 TLDF

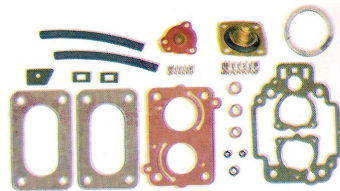

Krater: 33.15497/S
Autolex: 200.496/1
Uno Mille, Elba, Prêmio
Carb. Eletrônico TLDF

Carburadores Modelo Solex

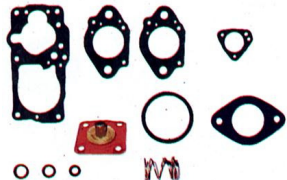

Krater: 34.16041/B
Autolex: 200.040
Passat, Voyage 1.5, Chevette 1.6
Carb. 35 PDSIT - gasolina

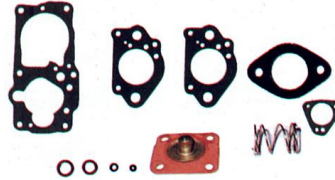

Krater: 34.16041/1/B
Autolex: 200.042
Chevette 1.6 - 2ª série 83

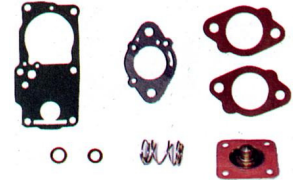

Krater: 34.16042
Autolex: 200.044
Chevette 1.4 - gasolina



Krater: 02.16050/2
Autolex: 200.050
Corcel, Del Rey 78/82 com válvula máxima - Carb.
34 SEIE - gasolina



Krater: 02.16054/2/S
Corcel, Belina, F-1000, Maverick, Opala, Chevette
Carb. 34 SEIE - gasolina

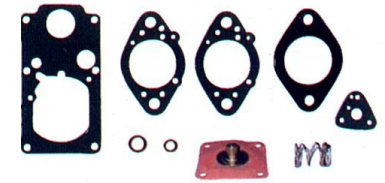

Krater: 02.16506/2
Autolex: 200.051
Pick-Up, Veraneio 64, Caminhão Chevrolet,
Ford F-100 - álcool



Krater: 02.16543/2
Autolex: 200.052
Opala, Caravan, Caminhão Chevrolet, Veraneio
Pick-up 4/6 cil. 1969 - álcool/gasolina
Com válvula de máxima

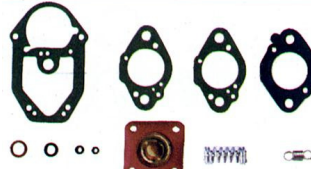

Krater: 34.16070/B/S
Autolex: 200.070
Fiat 1050 / 1300 - 76 / 82
Carb. 32 Dis 3 - gasolina

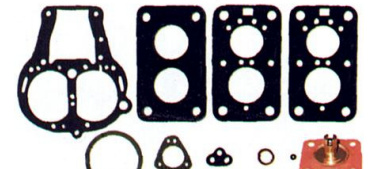

Autolex: 200.101
Passat 1.6 TS Importado



Krater: 34.16112/S
Autolex: 200.112
V.W. 1300 / 1500 / 1600 Sedan
Kombi, Brasília - gasolina



Krater: 34.16114/S
Autolex: 200.114
V.W. 1600 Sedan, Gol, Kombi

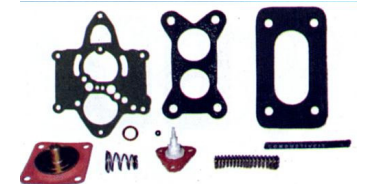

Krater: 02.16130/2/S
Autolex: 200.130
Ford CHT 1.6 87 - Carb. BLFA / Monza 1.8

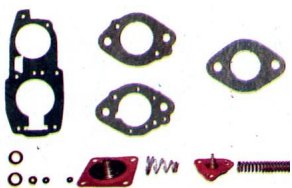

Krater: 02.16160/S
Autolex: 200.160
Monza 1.6/ 1.8 - Carb. 35 ALFA - álcool



Krater: 02.16175/2/S
Autolex: 200.175
Santana, Gol, Passat 1.8 e 2.0 Ford 1.0
Monza, Escort - Carb. 2-E



Krater: 02.16175EL2
Autolex: 200.175/1
V.W. Santana 2000
Carb. Eletrônico 2 CE



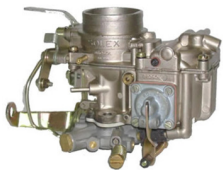

Reparos de Carburador



Krater: 02.16176/2/S

Autolex: 200.176

Monza, Kadett, Ipanema 2.0

Opala, Caravan 11/90 álcool/gasolina - Carb. 3E

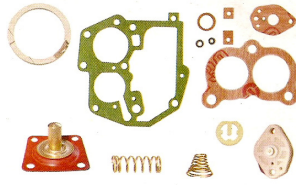

Krater: 02.16175/EL/2S

Autolex: 200.177

Santana, Quantum, Apolo 1.8 - gasolina

Versailles, Pampa, Chevette Jr. - Carb. Eletrônico

Carburador

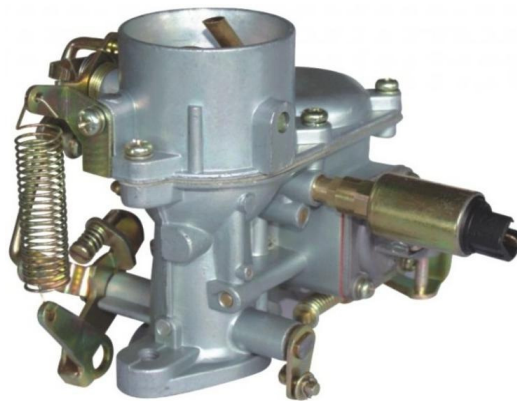

CARBURADOR VW 1300, 1500 e 1600 - SIMPLES (1 BOCAL)

PIC30 - YMAX

Com Agulha eletromagnética

CARBO1FUS - Euro

Sem Agulha eletromagnética

Componentes para Carburador



219 070

Mola do Acelerador - WV 1300

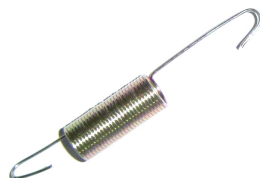

219 071

Mola do Acelerador - Brasília

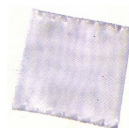

206 305

Tela filtrante dos
Calibradores
2E, 3E - Solex



206 038

Filtro Entrada de Combustível
Solex e Weber





KIT PARA CARBURADOR COMPLETO

(KIT + BÓIA + VÁLVULA NA EMBALAGEM SKIN) - WEBER



Código Krater:(K-89.15022/BVS)
Carburador 228 Weber simples
Aplicação: C-10/C-14/C-60 4.1
Gasolina 6 Cilindros. 1957/...



Código Krater:(K-89.15032/BVS)
Carburador 228 Weber simples
Aplicação: Opala/Caravan 2.5
Gasolina 4 Cilindros 1972/...



Código Krater:(K-89.15047/BVS)
Carburador 228 Weber simples
Aplicação: Chevette/Marajó 1.4
Gasolina 4 Cilindros 1973/81



Código Krater: (K-89.15107/BVS)
Carburador 228 Weber simples
Aplicação: Corcel II/Belina II 1.6
Gasolina 4 Cilindros 1974/...



Código Krater:(K-89.15116/BVS)
Carburador 228 Weber simples
Aplicação: Corcel II/Belina II 1.6
Alcool 1980/1983



Código Krater:(K-89.15190/BVS)
Carburador 190 Weber simples
Aplicação: Fiat 147 / Uno / Mille
motor 1050 Alc/Gas



Código Krater: (K-89.15191/BVS)
Carburador 190 Weber simples
Aplicação: Uno/Mille/Prêmio
Elba 1.3 /Monza 1.6/1.8 Alc/Gas.



Código Krater: (K-89.15450/BVS)
Carburador 450 Weber duplo
Aplicação: Gol/Parati/Passat/Corcel/D.Rey
1.4/1.6 Alcool 80/...



KIT PARA CARBURADOR COMPLETO

(KIT + BÓIA + VÁLVULA NA EMBALAGEM SKIN) - WEBER



Código Krater: (K-89.15451/BVS)
Carburador 450 Weber duplo
Aplicação: Gol/Parati/Passat/Corcel/D.Rey
1.4/1.6 Gasolina 80/...



Código Krater: (K-89.15452/BVS)
Carburador 450 Weber duplo
Aplicação: Gol/Voy/Pti/Passat/Chevette/Marajó
Corcel/D.Rey 1.4/1.6 Alcool/Gasolina 80/...



Código Krater: (K-89.15460/BVS)
Carb. 460 DMTB Weber duplo
Aplicação: CHT (Antigo) Corcel
Belina/Escort 1.4/1.6 Alc/Gasolina 87/...



Código Krater: (K-89.15460/M/BVS)
Carb. 460 DMTB Weber duplo
Aplicação: CHT (Moderno) Gol 1.0
Corcel/Belina/Escort 1.6 Alc/Gas 87/...



Código Krater: (K-89.15461/BVS)
Carb. 460 DMTB Weber duplo
Aplicação: Fiat 1.3 SX/ Uno
Prêmio/Elba 1.5 Alcool/Gasolina 86/89.



Código Krater: (K-89.15495/BVS)
Carb. 495 TLDZ Weber duplo
Aplicação: Gol/Parati/Voyage
Escort/Royalle 1.8 Alcool/Gasolina 1990/...



Código Krater: (K-89.15496/BVS)
Carb. 495 TLDZ Weber duplo
Aplic.: Gol/Pti/Voy/Escort/D.Rey
Royalle / Corcel II / 1.8 Alcool/Gasolina 1990/...

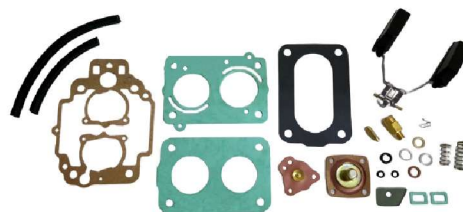

Código Krater: (K-89.15495/F/BVS)
Carb. 496 TLDF Weber duplo
Aplicação: Uno / Prêmio
Elba 1.6 Alcool/Gasolina 1990/...



KIT PARA CARBURADOR COMPLETO

(KIT + BÓIA + VÁLVULA NA EMBALAGEM SKIN)- SOLEX



Código Krater: (K-89.16040/BVS)
Carb. 35 PDSIT Solex simples
Aplicação: Passat LS / Parati Voyage 1.5 Gasolina 79/82



Código Krater: (K-89.16041/BVS)
Carb. 35 PDSIT Solex simples
Aplicação: Passat LS/Parati Voyage 1.5 Alc/Gas 79/82.



Código Krater: (K-89.16041/1/BVS)
Carb. 35 PDSIT Solex simples
Aplicação: Chevette/Marajó 1.4/1.6 Alc/Gas 1982/...



Código Krater: (K-89.16050/BVS)
Carb. 34 SEIE Solex duplo
Aplicação: Corcel / D.Rey Gasolina 78/82



Código Krater: (K-89.16070/BVS)
Carb. 32 DIS Solex simples
Aplicação: Fiat 147/1050/1300 Gasolina 76/82



Código Krater: (K-89.16072/BVS)
Carb. 32 DIS Solex simples
Aplicação: Fiat 147/1050/1300 Alcool 1979/...



Código Krater: (K-89.16112/BVS)
Carb. 30 PIC Solex simples
Aplicação: Fusca/Brasília/ Kombi 1.3/1.5/1.6 Gasolina



Código Krater: (K-89.16113/BVS)
Carb 32/34 PDSIT Solex duplo
Aplicação: Kombi Moderna 1.6 89/91



Código Krater: (K-89.16114/BVS)
Carb. 32/34 PDSIT Solex duplo
Aplicação: Brasília / Kombi/ Gol/ TC/ TL 1.6 Gas até 89



Código Krater: (K-89.16115/BVS)
Carb 32/34 PDSIT Solex duplo
Aplicação: Kombi/Fusca 1.6 Alc/Gas 91/...



KIT PARA CARBURADOR COMPLETO

(KIT + BÓIA + VÁLVULA NA EMBALAGEM SKIN)- SOLEX



Código Krater: (K-89.16130/BVS)
Carb. 30/34 BLFA Solex duplo
Aplicação: CHT 1.6 87/.. Monza 1.8 86/...



Código Krater: (K-89.16160/BVS)
Carb. 35 ALFA 1 Solex simples
Aplicação: Uno/Prêmio Elba 1.6
Monza 1.6/1.8 Alcool



Código Krater: (K-89.16161/BVS)
Carb. 35 ALFA 1 Solex simples
Aplic.: Monza 1.6/1.8 Gasolina



Código Krater: (K-89.16162/BVS)
Carb. 35 ALFA 1 Solex simples
Aplicação: Fiat 147/Uno/Prêmio
Elba/Fiorino - todos 1.3 Alcool 79/88



Código Krater: (K-89.16175/BVS)
Carburador 2E Solex duplo
Aplicação: Santana / Passat
Voyage / Monza / Kadett Ipanema 1.8 / 2.0



Código Krater: (K-89.16175/BVS/PR)
Carburador 2E Solex duplo
Aplicação: Santana/Passat/Voy/Monza
Kadett/Ipanema 1.8/2.0 c/ Válvula sem rosca.



Código Krater: (K-89.16176/BVS)
Carburador 3E Solex duplo
Aplicação: Santana/Quantum
Mz/Kadett/Ipanema 2.0



Código Krater: (K-89.16176/BVS/PR)
Carburador 3E Solex duplo
Aplicação: Santana/Quantum
Mz/Kadett/Ipanema 2.0 com válvula sem rosca



Código Krater: (K-89.16506/BVS)
Carburador: Solex simples
Aplicação: Opala/Caravan/Jeep/Rural
4/6 cilindros 71/76 Gasolina c/ válvula de máxima e baquelite.



Código Krater: (K-81.6001/C)
Carburador: Simples
Aplicação: Towner 800cc gasolina
com bóia, válvula de bóia e válvula de máxima.



Reparos de Injeção (TBI)



Anéis para Injeção



206 008

Jogo com 8 anéis para reparo de Injeção Eletrônica



206 009

Jogo com 8 anéis para reparo de Injeção Eletrônica - Celta , Corsa



Volkswagen



Krater: 03.1647

Autolex: 230.015

Logus, Pointer, Quantum, Santana, Gol GII, Gol CII - Single Point com Anéis



Krater: 03.1646/S

Autolex: 230.009

Gol 1.000 Plus (Single Point)



Krater: 03.1659/C

Autolex: 230.016

Gol GTI, Logus 2.0, Pointer 2.0, Santana 2.0, Quantum 2.0 - Multi Point c/ 8 anéis



Krater: 03.1669/C

Autolex: 230.032

Gol 1.8/2.0 Mi - Mod. 97, Santana 2.0 Parati CL 1.6, Gol 1.6 - Multi Point



Autolex: 230.042

Kombi 4 cil. Multi Point



Krater: 03.1678

Autolex: 230.048

Gol, Parati 1.0 Mi 8v Motor AT Bosch

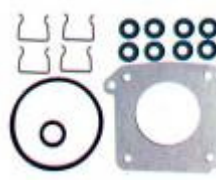

Autolex: 230.049

Gol, Parati 1.0 Mi todos 16v Magnet Marelli

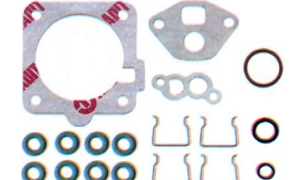

Krater: 03.1696/C

Celta VHC 1.0/1.4 03/... Corsa VHC 1.0/1.4/1.8 02/...Meriva 8/16v, Montana 1.8 02/03 MPFI gasolina/ flexpower

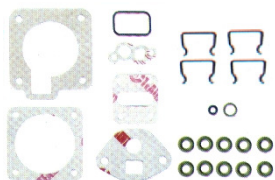

Krater: 03.1718

Vectra 2.0/2.2, Astra 2.0 97/... 16v MPFI - gasolina



Krater: 03.1722

Astra 1.8/2.0 98/04, Zafira 2.0 01/... 8/16v - gasolina



Krater: 03.1735

Autolex: 230.118

Fox 1.0 8v 03/... MPI



Krater: 03.1736

Juntas do coletor de admissão do Fox 1.0 03/... 8v gasolina/ totalflex - Multi Point



Krater: 03.1737

Fox, Polo Novo 03/... Golf 01/02 1.6 8v gasolina/ totalflex - Multi Point



Krater: 03.1738

Juntas do coletor de admissão Fox, Pólo 03/... Golf 01/02 1.6 8v Gasolina/totalflex - Multi Point





Reparos de Injeção (TBI)

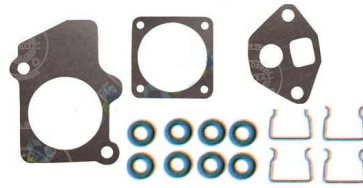

Autolex: 230.001
Kadett, Ipanema, Vectra, Omega 4 cil.
Tempra Turbo



Krater: 03.1640/C
Autolex: 230.003
Monza, Kadett, Ipanema, Corsa



Krater: 03.1665/C
Autolex: 230.011
Corsa Wind 1.0, Corsa GL 1.4,
Pick-Up, Corsa 1.6 I.F.I



Krater: 03.1650/C
Autolex: 230.019
Vectra 2.0 16V CD
Multi Point com 8 anéis



Krater: 03.1675/C
Autolex: 230.024
Corsa 1.0/1.6 M.P.I 8v - Multi Point
Celta VHC 4 bicos



Krater: 03.1668/C
Autolex: 230.030
Vectra GLS 2.0 8V
Multi Point



Autolex: 230.058
Vectra GLSi 16v M.P.I
Multi Point



Krater: 03.1718
Autolex: 230.059
Vectra 2.0 16v, Astra 2.0
M.P.F.I. Multi Point



Autolex: 230.094
Astra 1.8 8v, 16v Ano 99
Bosch Multi Point



Krater: 03.1691
Autolex: 230.050
Fiesta, Ka 1.0 / 1.3
Motor Endura - Multi Point



Krater: 03.1692
Autolex: 230.054
Fiesta CLX, Ka, Courier
Motor Zetec 1.4 - Multi Point 16v



Krater: 03.1693
Autolex: 230.053
Escort S. Wagon 1.8
Motor Zetec 16v - Multi Point

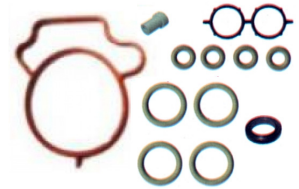

Krater: 03.1716
Ka, Fiesta, Escort, Ecosport, Focus - Zetec Rocam
1.0/1.3/1.6 97/... 8 v MPI - gasolina



Autolex: 230.012
Fiesta Single Point 1.3 Importado



Autolex: 230.026
Ka CLX 1.0/1.3
Multi Point - Motor Endura

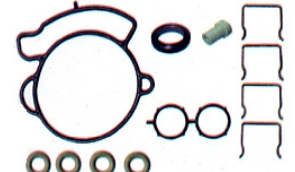

Autolex: 230.055
Escort GLX 16V
Motor Zetec - Multi Point





Reparos de Injeção (TBI)



Krater: 03.1644
Autolex: 230.004
Uno, Prêmio, Elba



Krater: 03.1645/B
Autolex: 230.008
Tipo I.E. (Mono Motronic)
Bosch 1.6 (c/ Calço)



Krater: 03.1642
Autolex: 230.010
Tempra 2000 I.E. (Single Point)



Krater: 03.1672/C
Autolex: 230.022
Palio 1.0 / 1.5 MPI 8v



Autolex: 230.031
Palio 16v
Multi Point



Krater: 03.1649
Autolex: 230.045
Siena, Palio 1.6
Single Point



Krater: 03.1664
Autolex: 230.046
Mille SX 1997 / Uno SX
M.M. Single Point (Sem Baquelite)

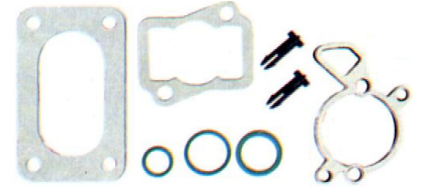

Krater: 03.1676
Mille SX 1997 / Uno SX
M.M. Single Point (Sem Baquelite)

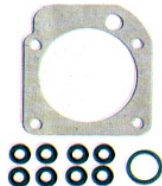

Krater: 03.1682
Brava 1.8/1.8 SX/ELX/HGTA, Palio, Siena, Week,
Strada MPI todos 1.6 96/... 16v - gasolina

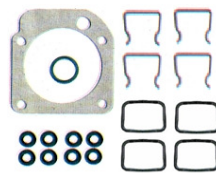

Krater: 03.1682/C
Brava 1.8/1.8 SX/ELX/HGTA, Palio, Siena, Week,
Strada MPI todos 1.6 96/... 16v - gasolina
com as juntas do coletor de admissão



Krater: 03.1705
Anéis do coletor de Admissão Palio EX, Palio
Young
MPI Fire 1.0/1.3 8v 99/03- gasolina

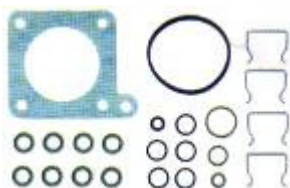

Autolex: 230.078
Palio ELX Fire, Palio Weekend ELX Fire, Palio City
Fire 1.3 16v 2000, Doblò ELX 1.3 16 v Fire 2002,
Siena ELX City Fire 1.3 16v 2000/... MPI



Autolex: 230.079
Palio EX 1.0 8v Fire 2001,
Palio Young 1.0 8v Fire 2001 MPI

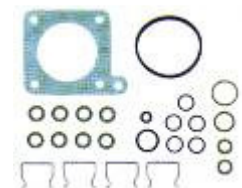

Autolex: 230.080
Palio ELX, Siena ELX, Palio Weekend ELX 1.3
16v Fire 2001 MPI



Autolex: 230.085
Palio 1.6 16v 96/2000, Palio Weekend Stile 1.6 16v
97/2000, Palio Stile, Palio Adventure 1.6 16v 2001, Palio
ELX MPI, Doblò ELX 1.6 16v 2002 MPI



Autolex: 230.086
Palio EX, Palio Young 1.0 8v
Fire 2001 MPI

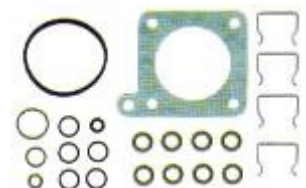











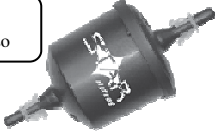



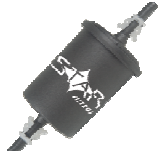
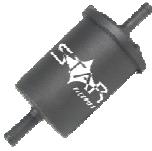



Autolex: 230.087
Palio, Siena, Palio Weekend - ELX
Siena ELX 1.0 16v Fire 2001 MPI





Filtros de Combustível























<p>Bicos Grosso/Grosso</p>  <p>BI5000 VW: Santana Gasolina 97/... Gol, Kombi Ál/Gas 97/... Parati, Saveiro 1.6/1.8 Similares: Autolex: 206.504 Fran: G5738/ Tec Fil: GI08/1 N° Original: 3.771.335.11A</p>	<p>Bicos Fino/Fino</p>  <p>BI5010 Ford: Escort, Fiesta, Ka 97/... Ranger V6, Mondeo ... /95 Similares: Autolex: 206.502 Fran: G5980/ Tec Fil: GI06/1 N° Original E7DE-9155-AA</p>	<p>Bicos Fino/Grosso</p>  <p>BI5020 VW: Gol 95, Logus, Santana, Quantum 1.8/2.0 EFI 94 Ford: Escort, Verona 1.8, 2.0 Versailles, Royale 1.8, 2.0 Similares: Autolex: 206.503 Fran: G8781/ Tec Fil: GI07/1 N° Original: 3.251.335.111</p>	 <p>BI6000 GM: Calibra 2.0 16V 90 /97, Omega Suprema 2.2 95/... Astra 2.0 16V 95/98, Kadett, Ipanema MPFI 1.8 2.0 96/... Vectra 2.0 GSI 94/96 Similares: Autolex: 206.505 Fran: G6400 / Tec Fil: GI03/1</p>
 <p>BI6010 GM: Corsa 1.0/1.4/1.6 Pick-up Corsa 1.6 Celta, Zafira, S-10 2.2/2.4 Renault: Kangoo Audi: A3 Similares: Autolex: 206.506 Fran: G5995/ Tec Fil: GI04/2</p>	 <p>BI6020 GM: Monza, Kadett, Ipanema todos 1.8/ 2.0 EFI Similares: Autolex: 206.507 Fran: G5471/ Tec Fil: GI02/2</p>	 <p>BI6030 Fiat: Palio todos 2001/... Brava 1.6/1.8/2.0/2.4 16V 99/... Marea, Weekend 2.0 20V 98/... Doblò 1.3 1.8 8V/16V Flex Similares: Fran: G5995 Tec Fil: GI04/2</p>	 <p>BI6040 Citröen: C3 1.4/1.6, Xsara Picasso 1.6/2.0 Peugeot: 206 1.0/1.4/1.6 8v 98-00 1.6 16V, 307 1.6/2.0 2004/... Renault: Clio 1.0/1.6 99/... Scenic 2.0 8V/16V Similares: Autolex: 206.516 Fran: G5857/ Tec Fil: GI50/1</p>
 <p>BI7000 Fiat: Palio .../2001 todos Siena, Strada Similares: Autolex: 206.508 Fran: G7729/ Tec Fil: GI41</p>	 <p>BI7010 Fiat: Marea, Marea Weekend 2.0 20V 99/... Brava todos Similares: Autolex: 206.510 Fran: G5493/ Tec Fil: GI40</p>	 <p>BI8000 VW: Golf GL/GLX 1.6/1.8/2.0 93/98 Pointer AP 1.8 AP 2.0 93/... Gol MPFI 2.0 95/97 Fiat: Tempra i.e. 2.0 95/... GM: Silverado 4.1 L 96/... Similares: Autolex: 206.509 Fran: G3829/ Tec Fil: GI01/1</p>	 <p>BI8010 VW: New Beetle 2.0 Bora 1.6, 1.8, 2.0 10-98/... Bora 1.6 16V 2-00/... Golf Nacional Audi: A3 1.6 Similares: Autolex: 206.515 Fran: G5870/ Tec Fil: GI10</p>
 <p>BI8020 VW: Fox 1.0 Gasolina, Total Flex Similares: Autolex: 206.514 Fran: G9892F/ Tec Fil: GI12</p>	 <p>BI9000 Ford: EcoSport 1.0 SuperCharge/ 1.6 2003/... 2.0 Duratex, Novo Fiesta 1.0/ 1.0 SuperCharge/1.6 todos 2002/... Similares: Autolex: 206.513 Fran: G9291/ Tec Fil: GI60</p>	<p>Filtros Carburados</p> <p>➔</p>	  <p>BM3000T Filtro para Moto Similares: Autolex: 206.512 Fran: G4196</p>
 <p>BG4000 Filtro p/ Gasolina (Pequeno) Encaixe Ø 6/8 mm (emb. plástica) Similares: Autolex: 206.501-S</p>	 <p>BA4000CX Filtro p/ Gasolina (Pequeno) Encaixe Ø 6/8 mm (emb. caixa) Similares: Autolex: 206.501-C</p>	 <p>BA2000 Filtro p/ Álcool (Grande) Encaixe Ø 6/8 mm (emb. plástica) Similares: Autolex: 206.500-S</p>	 <p>BA2000CX Filtro p/ Álcool (Grande) Encaixe Ø 6/8 mm (emb. caixa) Similares: Autolex: 206.500-C</p>

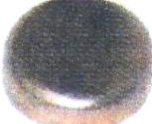

Selos do Bloco do Motor



 Volkswagen 	 NV-048 Selo Ø 14,0 mm Coletor Refrig. água	 NV-049 Selo Ø 16,0 mm Coletor Passat	 NV-053 Selo Ø 18,0 mm Coletor admissão	 NV-061 Selo Ø 20,1 mm Tampa vedação do coletor de água de admissão do Passat
 NV-050 Selo Ø 24,3 mm Tampa baixa cabeçote Passat	 NV-051 Selo Ø 36,8 mm Tampa bloco do motor	 	 NV-062 Selo Ø 10,0 mm Vira-Brequim do Fiat	 NV-049 Selo Ø 16,0 mm Cabeçote do Fiat
 NV-061 Selo Ø 20,1 mm Tampa coletor de admissão	 NV-064 Selo Ø 28,2 mm Cabeçote grande do Fiat	 NV-185 Selo Ø 30,4 mm Bloco do Motor 1.6 8V e 16V 92/...	 NV-059 Selo Ø 36,2 mm Tampa do Bloco	 NV-063 Selo Ø 12,0 mm Cabeçote pequeno Fiat
 NV-166 Selo Ø 40,2mm Tampa do Bloco Tempra, Tipo	 NV-170 Selo Bloco Traseiro Palio, Uno - Motor Fire	 GM 	 NV-053 Selo Ø 18,0 mm Cabeçote Monza, Kadett	 NV-050A Selo Ø 24,0 mm Alto Cabeçote Opala
 NV-074 Selo Ø 26,3 mm Coletor Monza, Kadett	 NV-071 Selo Ø 30,0 mm Tampa cabeçote Chevette	 NV-060 Selo Ø 34,4 mm Tampa bloco do Chevette	 NV-059 Selo Ø 36,2 mm Bloco Monza, Kadett	 NV-065 Selo Ø 40,5 mm Bloco comando Chevette
 NV-058 Selo Ø 41,5 mm Tampa Bloco lateral do Opala	 NV-080 Selo Ø 51,2 mm Tampa traseira do bloco	 	 NV-061 Selo Ø 20,1 mm Tampa Coletor Escort	 NV-083 Selo Ø 23,1 mm Tampa d'água cabeçote
 NV-243 Selo Ø 39,6mm Lateral Bloco Ford	 NV-174 Selo Ø 41,6 mm Bloco e Cabeçote Motor Endura Ka, Fiesta, Courier 96/99	 NV-093 Selo Ø 38,4 mm Tampa lateral do motor	  	 NV-053A Selo Ø 18,2 mm Alto Tampa vedação cabeçote alto (MWM) Tampa Lateral do Motor (Perkins)
 NV-089 Selo Ø 17,7 mm Tampa do bloco do motor	 NV-092 Selo Ø 35,3mm Tampa Bloco Motor (Perkins)	 NV-093 Selo Ø 38,4 mm Tampa lateral do motor (Perkins)		



Lista de Bujões para Carter



Imagem da Peça	Produto
	<p>LA-491</p> <p>Ford ka/ Fiesta/ Courier Motor Zetec/ Rocam 99/ M14x20 c/ Anel O'ring Chave Sextavada 13mm</p>
	<p>LA-430</p> <p>Uno / Palio Motor 1.0/1.3/1.5/ Fire M22 Cônico Chave Allen 10mm</p>
	<p>LA-2805</p> <p>Bujão do Carter Celta/ Vectra/ Monza M14</p>
	<p>LA-744</p> <p>Cônico</p> <p>Peugeot/ Toyota/ Honda/ Motos Bujão Recuperador de Rosca M12 Acompanha arruela Chave Sextavada 16mm</p>
	<p>LA-746</p> <p>Cônico</p> <p>Renault/Peugeot/Citroen/Fiat Bujão Recuperador de Rosca M16 - Acompanha arruela Chave Sextavada 22mm</p>
	<p>LA-749</p> <p>N.O. 7703075348 Peugeot / Renaut M16 - Chave Quadrada 8 MM</p>
	<p>LA-2516</p> <p>Bujão do Carter VW UP</p>
	<p>LA - 2815</p> <p>Bujão p/ Moto M 12 x 1,5</p>

Imagem da Peça	Produto
	<p>LA-489</p> <p>Vectra/ Astra/ Corsa/ Meriva/ Zafira/ Cobalt/ Prisma/ Montana/ Motor Flex Rosca M14 - Com anel O'ring Chave Torx 45</p>
	<p>LA-415</p> <p>Gol/ Parati/ Saveiro/ Polo/ Crossfox M14x1,5 Chave Allen 8mm</p>
	<p>LA-363</p> <p>Ducato / Boxer / Jumper M22 Chave Allen 10mm</p>
	<p>LA-745</p> <p>Cônico</p> <p>GM/ VW/ Ford/ Fiat/ Audi/ BMW/ Mercedes/ Motos Bujão Recuperador de Rosca M14 Acompanha arruela Chave Sextavada 19mm</p>
	<p>LA-748</p> <p>N.O. 90009P43000 Honda Fit/Civic / Kia/ Mitsubishi M14-Chave Sextavada 17 MM</p>
	<p>LA-2521</p> <p>Bujão do Carter Motor Cht Chave 13 MM Comp. Total 25 MM Comp. Rosca 14 MM</p>
	<p>LA-2803</p> <p>Bujão do Carter Toro / Renegade / Compass M 18 x 1,5</p>
	<p>LA - 2745</p> <p>Bujão recuperador de Rosca em Aço M 20 Aplicação: Linha diesel</p>

	<p>LA-425</p> <p>Fiat - Cabeçote Palio/ Siena Fire M16 X 1,0 Alumínio c/ Anel Chave Allen 8mm</p>
---	--

	<p>LA - 2811</p> <p>Bujão do cabeçote Fiat E Torque com anel N° original: 55227844</p>
--	---

	<p>LA - 2814</p> <p>Bujão Plástico Golf, Novo Fusca, Audi N° Original: 06L103801</p>
---	---

	<p>LA - 2829</p> <p>Chave p/ bujão plástico (LA - 2814)</p>
--	--

	<p>LA-2801</p> <p>Arruela de bujão Renault M - 16 Metal borracha</p>
---	---

	<p>LA-1842</p> <p>N.O. NT Arruela de Alumínio M 12 x 16</p>
--	--

	<p>LA-1843</p> <p>N.O. NT Arruela de Alumínio M 14 x 20</p>
--	--

	<p>LA-1844</p> <p>N.O. NT Arruela de Alumínio M 16 x 22</p>
---	--

	<p>LA-2518</p> <p>Arruela Flandres N/ Amianto 14 X 20</p>
---	--

	<p>LA-2520</p> <p>Arruela Flandres N/ Amianto 16,2 X 22,3</p>
--	--

	<p>LA-2517</p> <p>Arruela Cobre N/ Amianto 14 x 20</p>
---	---

	<p>LA-2519</p> <p>Arruela Cobre N/ Amianto 16,2 x 22,3</p>
--	---

	<p>LA - 489A</p> <p>Arruela oring do bujão Linha GM (LA 489)</p>
---	---

	<p>LA - 491A</p> <p>Arruela oring do bujão Ka/Fiesta (LA 491)</p>
--	--

Guarnição para moto bomba
Ford

1701



Borracha do reservatório de partida
Gol / Logus / Pointer



1705

Tampa do óleo do motor
A10/A20/C20/Caravan/Chevette/
Opala/Veraneio



1708
nº orig. 8.966.781

Vedador do tubo da vareta de óleo
Doblo/Fiorino/Mille/Palio/Siena/
Strada
Todos com motor Fire



1711

Junta de vedação
Do módulo de injeção (Autódromo)
(Embalagem com 10 peças)



2002

Guarnição do Reservatório
de partida
Universal

1702



Bucha isoladora do pedal
do acelerador
Gol/Parati/Santana/
Quantum e Versailles



1706

Guarnição do reservatório
de partida
Fox/Pólo/Gol GV/Voyage



1709
nº orig. 520.201.231-A

Vedador do tubo da vareta de óleo
Fiorino 96 1.0 / Palio 96/00 /
Siena 98/02 / Strada 1.5-1.6 /
Tipo 1.6 / Uno 1.6 R



1712

Tampa da tomada de vácuo
Monza/Kadett/Ipanema/Corsa
(Embalagem com 10 peças)



2009

Guarnição do Reservatório de
partida a frio
Ford
Ka 09/13 / Ecosport 04/... / New Fiesta 10/13 /
Fusion 13/... Courier 07/13 / Fiesta Rocan 03/14 /
Focus 00/09
GM
Celta 06/15 / Onix/Spin/Cobalt 13/... / Astra/
Vectra 01/12 / Montana 11/...

1703
nº orig. 7S459374/AA



Borracha de vedação
De respiro de óleo da tampa de
válvula dos motores AP-VW/FORD



1707

Guarnição de Vedação
Eletrobomba
Palio/Weekend/Siena 96/18
Idea 06/16 Grand Siena 12/...
Strada 96/...



1710
nº orig 46.439.385

Vedador do tubo da vareta de óleo
Elba/Fiorino/Mille/Prêmio
(Exceto com motor fire)



1713

Anel de vedação
Da bobina de ignição
Fiat (todos com motor fire)

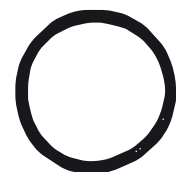

2097
Medidas 36,09 x 3,53
nº orig. 14.463.980

Anel de vedação da bobina de ignição
Corsa 95/12 / Celta 01/16 /
Spin 13/17 / Cobalt 12/16

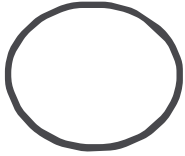

2098
Medidas 64,77 X 2,62
nº orig. 93.278.411

Borracha de vedação
Para saída e retorno de combustível
no módulo.
Courier 02/... Focus (02 unidades)



5006

Anel de vedação do tubo d'água
Linha Fiat



2110
Medidas 29,74 X 3,53
nº orig. 14.463.570

Junta de vedação da flauta
Ford Zetec 1.4 16V/1.8 16V(04 juntas)



5005

DSC2015

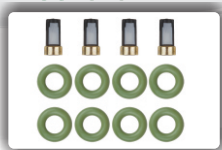

KIT REPARO PARA BICO INJETOR MPFI
SISTEMA BOSCH/ ROCHESTER

DSC2016



KIT REPARO PARA BICO INJETOR MPFI
SISTEMA MAGNETI MARELLI

DSC2017

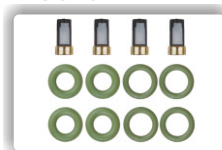

KIT REPARO PARA BICO INJETOR
SISTEMA BOSCH/ROCHESTER CELTA
CORSA / VECTRA / S-10 99/...
BICO INJETOR: 25.319.301

DSC2018

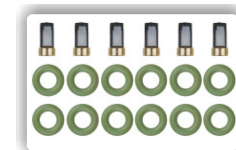

KIT REPARO PARA BICO INJETOR MPFI
SISTEMA BOSCH/ROCHESTER ÔMEGA
3.0/4.1 6 CILINDROS

DSC2019

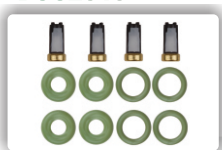

KIT REPARO PARA BICO INJETOR MPFI
SISTEMA MAGNETI MARELLI
ZAFIRA 1.8 / PALIO / STILO

DSC2023

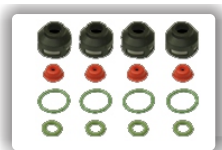

KIT REP P/BICO INJ. FIESTA NAC.
COURIER 1.4 16V ZETEC
COD. BICO INJETOR: 96MF/9F593/AB

DSC2024

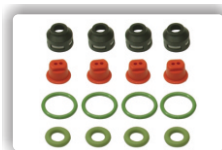

KIT REP P/BICO INJ. ESCORT 97/
MOTOR ZETEC 1.8 16V
CÓD. BICO INJ: 958F/9F593/BB

DSC2025



FILTRO PARA BICO INJETOR MULTI
POINT SISTEMA BOSCH
SEM ORING (4 FILTROS)

DSC2026



FILTRO PARA BICO INJETOR MULTI
POINT SISTEMA M. MARELLI
SEM ORING (4 FILTROS)

DSC2036

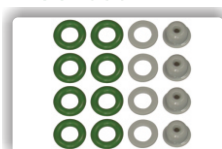

KIT DE PONTA P/ BICO INJETOR MULTI
POINT SISTEMA BOSCH

DSC2037

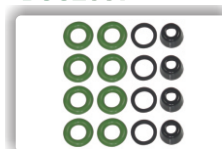

KIT DE PONTA P/ BICO INJ MULTI POINT
SISTEMA M. MARELLI
CÓD. BICO INJ: 214.303.000.100/1W330

DSC2038



KIT DE PONTA P/ BICO INJ MULTI POINT
SISTEMA M. MARELLI
CÓD. BICO INJ: 214.303.700.100/1W073
214.300.700.200/1W074

DSC2064



KIT REP P/BICO INJ. SINGLE POINT
TIPO 1.6 (IMP.) 94/... RENAULT 19 1.6 96/...
CLIO 1.6 97/...
CÓD. BICO INJ: 0.280.150.698

DSC2077

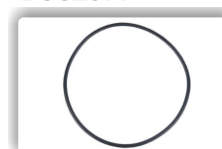

GUARNIÇÃO DA FLANGE DO MÓDULO
DE COMBUSTÍVEL
KADETT / IPANEMA 97/...

DSC2078

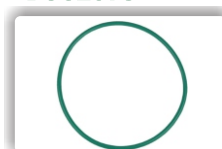

GUARNIÇÃO DA FLANGE DO MÓDULO DE
COMBUSTÍVEL PEUGEOT 206 (TODOS)
PARTNER (TODOS) / 406 (TODOS)
306 98/01 1.8 16 V

DSC2079



GUARNIÇÃO DA FLANGE DO MÓDULO DE
COMBUSTÍVEL RENAULT CLIO III/III / LAGUNA
LOGAN / SANDERO / MEGANE II / SCENIC II
TWINGO

DSC2080



GUARNIÇÃO DA FLANGE DO MÓDULO
DE COMBUSTÍVEL ESCORT 88/92
F-1000 92/98 / HOBBY 93/96

DSC2081

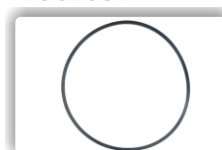

GUARNIÇÃO DA FLANGE DO MÓDULO
DE COMBUSTÍVEL
RANGER 97/...

DSC2082

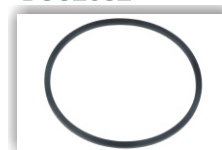

GUARNIÇÃO DA FLANGE DO MÓDULO
DE COMBUSTÍVEL
F-250 / F-350 98/...

DSC2083

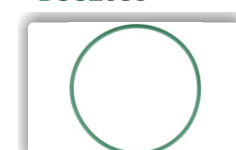

GUARNIÇÃO DA FLANGE DO MÓDULO
DE COMBUSTÍVEL DOBL0 02/...
PUNTO 09/... STILO 03/... LINEA 09/...

DSC2084



GUARNIÇÃO DA FLANGE DO MÓDULO
DE COMBUSTÍVEL
FIAT - MOTOR 1.5 (10 FUROS)

DSC2085

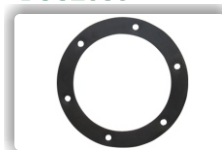

GUARNIÇÃO DA FLANGE DO MÓDULO
DE COMBUSTÍVEL
VECTRA 94/96 / ASTRA 95/96
N.ORIG. 90.232.009

DSC2086



GUARNIÇÃO DA BÓIA TUBULAR
FIAT (8 FUROS)

DSC2087



GUARNIÇÃO DA FLANGE DO MÓDULO
DE COMBUSTÍVEL
PEUGEOT 306 / CITROEN XANTIA
N.ORIG. 15.28.23

DSC2088

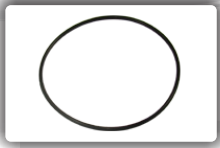

GUARNIÇÃO DA FLANGE DO MÓDULO DE COMBUSTÍVEL
PEUGEOT 307 / CITROEN C3
N.ORIG. 15.31.41

DSC2089



GUARNIÇÃO DA FLANGE DO MÓDULO DE COMBUSTÍVEL
CORSA/MERIVA/MONTANA 1.8 FLEX 03/
N.ORIG. 93.360.898

DSC2090



JUNTA DE VEDAÇÃO DO MED DE NÍVEL
GOL/VOY/PAR/SAV 83/96 (S/ I.E.)
SANTANA/QUANTUM (TODOS S/ I.E.)
N.ORIG: ZBA/919131/A

DSC2091



JUNTA DE VEDAÇÃO DO MED DE NÍVEL
IPANEMA/KADETT 94/98 (EFI/MPFI)
OPALA 90/92 C/D20 93/96 SILVERADO 97/01
N. ORIG.: 93.205.389

DSC2092

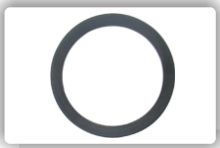

GUARNIÇÃO DA BÓIA TUBULAR
ELBA/FIORINO/UNO/PRÊMIO .../95

DSC2093



GUARNIÇÃO DA FLANGE DO MÓDULO DE COMBUSTÍVEL
CIVIC 1.8 GAS. 07/... CIVIC 1.8 FLEX 07/...
Nº ORIG. 170.52

DSC2094



JUNTA DO TANQUE DE COMBUSTÍVEL AO TUBO
ESCORT 86/... HOBBY 93/96

DSC2095



JUNTA DO TANQUE DE COMBUSTÍVEL AO TUBO
ESCORT 93/... (TODOS) / F1000 92/98

DSC2096

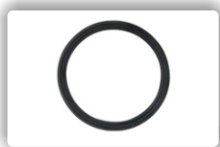

JUNTA DE VEDAÇÃO DO MEDIDOR DE NÍVEL
ELBA/FIORINO/PRÊMIO/UNO .../88

DSC5001

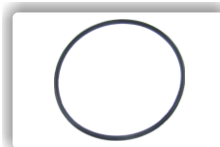

GUARNIÇÃO DO FILTRO DE AR
FIAT UNO (TODOS - MONOPONTO)

DSC5002



GUARNIÇÃO DO FILTRO DE AR
CORSA (TODOS-MONOPONTO)

DSC5003

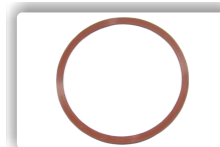

GUARNIÇÃO DO FILTRO DE AR
MONZA (TODOS-MONOPONTO)

Mangueiras Corrugadas p/ Bomba de Combustível

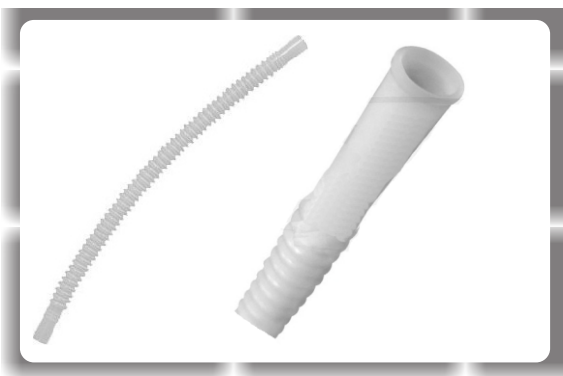

Código	Comprimento	Ø Bocal 1	Ø Bocal 2
DSC 20230	230 mm	7,5 mm	7,5 mm
DSC 20260	260 mm	7,5 mm	7,5 mm
DSC 20260E	260 mm	7,5 mm	9,0 mm
DSC 20320A	320 mm	7,5 / 9,0mm	7,5 / 9,0mm
DSC 20320B	320 mm	7,5 / 9,8mm	7,5 / 9,8mm
DSC 20330	330 mm	7,5 mm	7,5 mm

Guarnição da Bomba de Combustível



2067
Fiat: Todos
Gasolina/Álcool



2068
GM: Corsa 94/99
Vectra, Astra
Tanque de Lata



2069
VW: Gol 96, Santana
Ford: Versailles, F-1000
Renault: R 19
Gasolina/Álcool



2070
VW: Gol, Parati, Saveiro,
Logus, Pointer
Ford: Escort, Verona, Pampa
Gasolina/Álcool



2071
GM: S 10, Blazer



2072
Ford: Courier



2074
GM: Ômega 2.0, 2.2, 3.0, 4.1i
Todos Gasolina 92/...



2075
GM: Corsa Novo, Astra,
Meriva, Zafira



2076
GM: Corsa Antigo, Astra,
Celta - Tanque de Plástico



www.nckdistribuidora.com.br

Guarnição Bomba Injetora



1701
Bico Grosso - Ford
Embalagem com 10 peças



1702
Bico Fino - VW, Fiat, GM
Embalagem com 10 peças



1705
VW - Gol Novo, Logus, Pointer
Embalagem com 10 peças



Renault / Gol / Logus / Saveiro / Polo Classic / Agile / Pointer / Escort / Pampa / Verona / Corsa Prisma / Celta / Marea / Honda Civic / Fit / Parati
Código Original: 547998055/93280050 / 547919131/1757451AE01



AVG0001



Linha GM Astra 99 1.8-2.0 8/16V todos Corsa / Vectra / Zafira todos
Código Original: 90572097



AVG0002



Linha Ford - Courier todas / Focus com Reservatório Plástico / Escort SW / Fiesta Sedan / EcoSport / Ka Flex / Courier Flex
Código Original: 98AP9276AB



AVG0003



Linhas VW- Ford - Renault / Gol / Santana / Quantum / Versailles / F100-F1000 Royale / Fiesta Sedan / Street 1.0 / 1.3 / 1.4 / Ka 1.0-1.3-1.4 todos
Código Original: 325998053/377919133



AVG0004



Linha Fiat Palio / Uno / Strada Weekend / Siena Sistema Parafuso 12 Furos
Código Original: 7527545



AVG0005



Kadett Ipanema MPFI 97 >
Código Original: 92211923



AVG0006



Linha GM Família Corsa todos 94 > fevereiro de 99 / Vectra 2.0 97
Código Original: 90.411.085



AVG0007



Blazer / S10 2.2 MPFI Blazer 4.3 V6 todas 96 > 00
Código Original: 25027014



AVG0008



Omega 2.0/2.2/3.0/4.1 92 >
Código Original: F000TE1131 90322794



AVG0009



Fiat Stilo / Peugeot 206 1.0/1.4/1.6 8/16V 98 > Citroen Xsara / Berlingo / Picasso
Código Original: 153124



AVG0010



Renault Clio >00 / Scenic 99 > / Megane 98 > / Kangoo e Twingo >00 / Logan 07 / Master 03 / Sandero 08
Ref. Montagem 7.701.209.115



AVG0011



Linha GM Montana 1.8 Flex / Meriva Astra / Vectra 2.0 / Corsa 03 >
Código Original: 93.360.898



AVG0012



Sistema Fiat Motor 1.5 10 Furos
Ref. Montagem MAM 000.44.50.004.900



AVG0013



Alfa Romero 147-156-166
Doblo/Punto/Stilo Gasolina / Linea
Código Original: 46.523.406

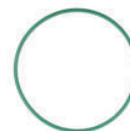

AVG0020



Linha Peugeot 307-207 / Peugeot 405
Citroen C3 - C5 / C4 Pallas
Código Original: 153.141



AVG0021



Honda Civic 1.8 Gas. Flex >07
Código Original: 17052



AVG0022



Sistema Toyota Corolla 02 >08 / Fielder
Ref. Montagem 77024-12010



AVG0023



Classe A todos A160 e A190
Ref. Montagem A1684701094



AVG0024



Vectra 94/96 / Astra 95 >96
Código Original: 90.232.009



AVG0025



Hyundai Tucson 2.0 Gasolina 04 >11
Código Original: 311152E300



AVG0037



HB20/HB20 S1.0 1.6

S10 Flex

Código Original: 311152P000



AVG0038



Nissan Livina / Grand Livina /Tiida /Novo Sentra

Código Original: 17342AZ60A



AVG0039



Linha GM Cobalt / Onix / Prisma

Código Original: 52.029.978



AVG0040



Linha GM Spin 13> / Sonic 12 / Omega 99>11 / Track 14> /

Cruze 12> Captiva 08> / Malibu 10> / Camaro 11>

Código Original: 22.682.111 / 4L3Z9276AA



AVG0041



Kia Soul Flex 1.6 16V 12 / KIA Picanto Flex / Kia Sorento Gasolina

Código Original: 31110-2K7000 3111-1Y700



AVG0042



S10 2.2/Blazer 4.3V6 - Diesel Elétrico 06

Código Original: 93.291.594



AVG0043



Toyota Hilux 04>

Ranger 2.5 16V Flex 12>

Código Original: 77169-0K010



AVG0044



Toyota Etios 12>

Código Original: 77169-0D060



AVG0045



Toyota Corolla 08>14

Código Original: 77169-02080



AVG0046



Citroen C3 /C4 Aircross 14

Código Original: 153153



AVG0054



Renault Logan / Sandero 13>
Código Original: 7.701.207.449



AVG0055



Cobalt / Onix / Prisma / Spin 15>
Código Original: 52.101.881



AVG0056



F-250 / F-350 98>
Código Original: F75Z/9A307/AA

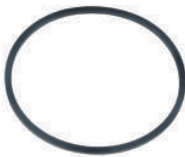

AVG0057



Peugeot 405 / 605 / 806 / Citroen / Xantia
Código Original: 15.28.23



AVG0058



VW Jetta 1.0/1.5
Código Original: 150919133B



AVG0062



Ranger 97>
Código Original: F87A/9417/AA



AVG0063



Honda Civic flex 12>



AVG0068



S10 12>18 / Trail Blazer 13> 18 2.5 2.8 Diesel S10 2.4 8V Flex
Código Original: 94.726.496



AVG0069



Mitsubishi Pajero



AVG0070



Hyundai / Santa Fé



AVG0071



Fiat Mobi 1.0 4 Cilindros 8V Flex
Código Original: 00.52032121001

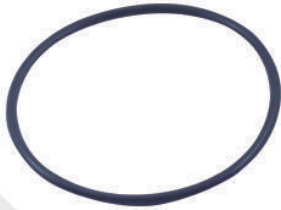

AVG0081



Hyundai I30 2.0 4 Cilindros 16V Gasolina
Código Original: 31115-H000



AVG0082



Hyundai Elantra 2.0 4 Cilindros 16V Flex
Kia Cerato 1.6 4 Cilindros 16V Flex
Kia Soul 1.6 4 Cilindros 16V Flex
Código Original: 311233X000 / 31110A5750 / 083002920



AVG0083



**Hyundai Elantra 1.6 4 Cilindros 16V / Elantra 1.8 4 Cilindros 16V /
Elantra 2.0 4 Cilindros 8V / Elantra 2.0 4 Cilindros 16V Gasolina**
Kia Picanto 1.0 4 Cilindros 12V Flex
Código Original: 3111007150 / 3111007000 / 311152D000 / 311101Y700



AVG0084



Fiat Ducato 2.3 4 Cilindros 8V / Ducato 2.3 4 Cilindros 16V Diesel
Código Original: 7743530 / 0580303061 / 1341606080



AVG0085



CÓDIGOS DUPARTS-ASSVE	CÓDIGO ORIGINAL	REFERÊNCIA CRUZADA
AVG0001	93.280.050	Cristal20210 DS1450 DSC2070/2076
AVG0002	90.572.097	Cristal20212 DS1456 DSC2075
AVG0003	98AP/9276AB	Cristal20211 DS1458 DSC2072 VP7123
AVG0004	325.998.053	Cristal20220 DS1451 DSC2069
AVG0005	7.527.545	Cristal20230 DS1453 DSC2067 VP7029
AVG0006	92.211.923	Cristal20214 DS1455 DSC2077
AVG0007	90.411.085	Cristal20240 DS1457 DSC2068
AVG0008	25.027.014	AVG0043 Cristal20245 DS1452 DSC2071/5023
AVG0009	90.322.794	Cristal20290 DS1454 DSC2074 VP7033
AVG0010	15.31.24	DS1459 DSC2078
AVG0011	7.701.209.115	AVG0055 DS1462 DSC2079/5024
AVG0012	93.360.898	DS1461 DSC2089
AVG0013	MAM44.50.004.900	DSC2084
AVG0020	46.523.406	DS1463 DSC2083 VP7118
AVG0021	15.31.41	AVG0054 DS1465 DSC2088/5018
AVG0022	17.052	DS1460 DSC2093
AVG0023	77024-12010	DS1473
AVG0024	A1684701094	DS1483
AVG0025	90.232.009	DS1485 DSC2085
AVG0037	3.111.52E.300	DS1478 DSC5021
AVG0038	311152P000	DS1469 DSC5013
AVG0039	17342AZ60A	DS1470 DSC2073
AVG0040	52.029.978	AVG0045/46/56 DS1468 DSC2099/5015 DSC5016/5025
AVG0041	22.682.111	DS1466 DSC5020
AVG0042	31110-1Y700/2K700	AVG0071 DS1479 DSC5022
AVG0043	93.291.594	AVG0008 Cristal20245 DS1452 DSC2071/5023
AVG0044	77169-0K010	DS1471 DSC5014
AVG0045	77169-0D060	AVG0040/46/56 DS1468 DSC2099/5015 DSC5016/5025
AVG0046	77169-02080	AVG0040/45/56 DS1468 DSC2099/5015 DSC5016/5025
AVG0054	15.31.53	AVG0021 DS1465 DSC2088/5018
AVG0055	7.701.207.449	AVG0011 DS1462 DSC2079/5024
AVG0056	52.101.881	AVG0040/45/46 DS1468 DSC2099/5015 DSC5016/5025
AVG0057	7.714.400.050	DS1474 DSC2082
AVG0058	15.31.53	DS1464 DSC2087
AVG0062	150919133B	DS1477 DSC5019
AVG0063	F87A/9417/AA	DS1486 DSC2081
AVG0068	17046TROA00	DS1475
AVG0069	94.726.496	DS1467 DSC5026
AVG0070	MR271159 1760A-227/297	DS1488
AVG0071	311153J500	AVG0042 DS1479 DSC5022
AVG0081	00.52032121001	DS1472
AVG0082	31115-H000	DS1476
AVG0083	311233X000 31110A5750 083002920	DS1480
AVG0084	3111007150 3111007000 311152D000 311101Y700	DS1481
AVG0085	7743530 0580303061 1341606080	DS1484



Doblo 02 / Linea 09 / Brava 11 / Punto 11 / Stilo 2003
Código Original: 46.523.405



AVG0031



Escort / Verona 83 > 92 F-1000 / F-400 93/98 Hobby
Código Original: 2SB/201159



AVG0032



Spin 13 > / Cobalt 12 > / Onix 13 > / Prisma 13 >
Código Original: 52.058.998



AVG0033



Nissan/Livina/Grand Livina/Tiida/Novo Sentra
Código Original: 17343AZ60A



AVG0034



Honda Fit Civic 01 > 08
Código Original: 17719-S1AE01 / 17719-SCAE01



AVG0035



HB20 HB20 S 1.0/1.6 / X 35
Código Original: 311152P000



AVG0036



Toyota Corolla 08 > 14
Código Original: 77144/52030



AVG0047



New Fiesta/Focus 00 > 13 / Novo EcoSport / Focus 14 / Novo KA 14
Código Original: 2S61/9C385/AA



AVG0048



Honda New Civic 07/11 Flex
Código Original: 17046.SNA-000



AVG0049



Toyota Hilux 2.5/2.7/3.0/4.0 05
Código Original: 77144-0K010



AVG0050



**Familia Escort/Escort SW Verona / Renault / Corsa Celta / Marea 1.8-2.0-2.4
Honda Civic 1.7 / Fit 1.4-1.5**
Código Original: 97AG/9C385/AA



AVG0014



Linha Ford Courier/Fiesta/Focus com Reservatório Plástico /Escort EcoSport
Código Original: 98AB/9C385/AB



AVG0015



**Fiat Stilo 1.8 05> / Peugeot 206/406/306 98> / Citroen Xsara Berlingo /
Picasso Parthner todos**
Código Original: 15.31.20



AVG0016



**Renault Clio >00 Scenic 99> Megane 98> Kangoo e Twingo >00
Logan / Laguna / Sandero**
Código Original: 701.209.115



AVG0017



Linha Peugeot 207/307 Peugeot 405 Citroen C3 / C5 / C4 Pallas
Código Original: 15.31.30



AVG0018



Kadett / Ipanema 97>98
Código Original: 93.215.701



AVG0019



Peugeot 306 / Citroen Xantia
Código Original: 15.31.25



AVG0027



Parati / Gol 97> Logus / Pointer / Golf 98 Saveiro / Polo Classic
Código Original: 201375A



AVG0028



Renault Megane / Clio I



AVG0029



Fiat Tipo / Marea Weekend
Código Original: 7.638.436



AVG0030



Kombi 97>14/Santana 94>06/Fox/Spacefox 04>
Código Original: 520.201.255/325.919.133.-1

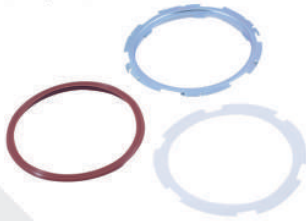

AVG0051



Toyota Etios / Etios Sedan
Código Original: 771440D050



AVG0052



Citroen /C3 /C4 Aircross 14
Código Original:153153



AVG0053



Renault Logan Sandero 13>
Código Original: 7.701.207.449



AVG0059



Cobalt /Onix/Prisma /Spin 15>
Código Original: 52.101.881



AVG0060



F-250 /F-350 98>
Código Original: F75Z/9A307/AA



AVG0061



Citroen Xsara / Picasso / Berlingo
Código Original: 15.31.20



AVG0067



Onix 13>17 / Prisma 13>17 / Spin 13>18 / Cobalt 14>18
Código Original: 52.071.052

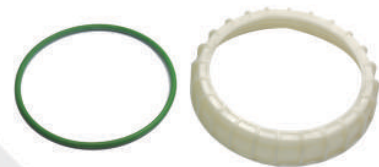

AVG0074



S10 12>18 / TrailBlazer 13>18 2.5 2.8 Diesel / S10 2.4 8v flex
Código Original:94.726.497



AVG0075



Celta 01> / Corsa 99>
Código Original: 93.278.521



AVG0076



Citroen C3 Aircross 1.6 4C 16V 10>
C41.6/2.0 4C 16V 10>
DS3-DS4 1.6 4C 16V 10>
todos Flex



AVG0077



Nissan Frontier 2.5 4C 16V Diesel 12>
Livina 1.6/1.8 4C 16V Flex 12>
Sentra 2.0 4C 16V Flex 12>



AVG0078



Honda Civic 1.8 4C 16V Flex 12>16



AVG0079



Honda Fit 1.5 4C 16V Flex 03>13



AVG0080



Linha Oval Fiat 12 Furos



AVG0086



Ford Ranger 97>12



AVG0087



GM Meriva 09>12 - Montana 09>17



AVG0088



CÓDIGOS DUPARTS-ASSVE	CÓDIGO ORIGINAL	REFERÊNCIA CRUZADA
AVG0014	97AG/9C385/AA	DS27001G DSC4001G
AVG0015	98AB/9C385/AB	DS27005G DSC4005G
AVG0016	15.31.20	DS27006G DSC4006G
AVG0017	7.701.209.115	DS27002G DSC4002G
AVG0018	15.31.30	DS27014G DSC4014G VP7142
AVG0019	93.215.701	DS27016G DSC4016G VP7143
AVG0027	15.31.25	DS27015G DSC4015G
AVG0028	321/201375A	DS27003G DSC4003G VP7053
AVG0029	7.701.209.115	DS27012G DSC4012G
AVG0030	7.638.436	DS27007G DSC4007G VP7110
AVG0031	46.523.405	DS27009G DSC4009G VP7112
AVG0032	2SB/201159	DS27004G DSC4004G
AVG0033	52.058.998	DS27017G DSC4017G
AVG0034	17343AZ60A	DS27018G DSC4018G
AVG0035	17718-S1A-E01	DS27019G DSC4019G
AVG0036	311152P000	DS27020G DSC4020G
AVG0047	7.714.452.030	DS021G DSC4022G
AVG0048	2S61/9C385/AA	DS27022G DSC4023G
AVG0049	17046-SNA-000	DSC4024G
AVG0050	7.714.40K.010	DS27024G DSC4025G
AVG0051	5Z0.201.255	DSC4026G
AVG0052	7.714.40D.050	DS27025G DSC4027G
AVG0053	15.31.53	DS27026G DSC4028G
AVG0059	7.701.207.449	DS27027G DSC4029G
AVG0060	52.101.881	DS27028G DSC4030G
AVG0061	F75/9A307/AA	DS27011G DSC4011G
AVG0067	52.101.881	DS27006G DSC4008G
AVG0074	52.071.052	DS27029G DSC4031G
AVG0075	94.726.497	DS27030G DSC4032G
AVG0076	93.278.521	DS27013G DSC4013G VP7178
AVG0077	153150 9685960380BA	DS27008G
AVG0078	1734379900	DS27034G
AVG0079	17046TROA00 YB1E	DS27031G
AVG0080	NF2M5R - NF259P 10903 17052TK6A00	DS27036G
AVG0081	00.52032121001	DS1472
AVG0086	46.763.006	DSC4067G
AVG0087	94.732.837	DSC4068G
AVG0088	F87A/9A307/CA	DSC4010G



Flange de Combustível e Guarnição AVG0039
Jeep Renegade



AKT0033B



Flange de Combustível e Guarnição AVG0005
Fiat Palio



AKT0035B



Flange de Combustível e Guarnição AVG0011
Renault Duster



AKT0036B



Flange de Combustível e Guarnição AVG0020
Fiat Mobi



AKT0037B



Flange de Combustível e Guarnição AVG0039
Nissan Sentra



AKT0038B



Flange de Combustível e Guarnição AVG0021
Peugeot 208



AKT0040B



Flange de Combustível e Guarnição AVG0069
Nissan Kicks / March



AKT0041B



Flange de Combustível e Guarnição AVG0011
Renault Kangoo (Argentina)



AKT0042B



Flange de Combustível e Guarnição AVG0010
Fiat Doblo



AKT0043B



Flange de Combustível e Guarnição AVG0063
Ford Ranger



AKT0044B



Flange de Combustível e Guarnição AVG0011

Renault Clio



AKT0045B



Flange de Combustível e Guarnição AVG0011

Fiat Linea



AKT0046B



**Tubo Regulador
Acompanha Oring e Espaçador**

Nissan



AKT0047B



**Tubo Regulador
Acompanha Oring e Espaçador**

Nissan



AKT0048B



**Tubo Regulador
Acompanha Oring e Espaçador**

Fiat



AKT0049B



Niple

Fiat Mobi



AKT0050B



CÓDIGOS DUPARTS-ASSVE	CÓDIGO ORIGINAL	REFERÊNCIA CRUZADA	DESCRIÇÃO
AKT0033B	52.051.198	53.361.917	TSA030074
AKT0034B	8.200.687.969	DS2451 - VP7103 - TSA030047	Flange de Combustível Jeep Renegade - Fiat Toro
AKT0035B	2.206.648	DS2004 - VP7010 - TSA030017	Renault Kangoo/ Scenic 1.6 4CC 16V Flex à partir 2005
AKT0036B	111.495AA	---	Flange de Combustível Palio Weekend 1.0/1.3 Gasolina - Strada 1.0/1.4 - Siena 1.0/1.4 - Uno 1.0/1.4 - Palio 1.0/1.4 - Flex
AKT0037B	---	---	Flange de Combustível Renault Duster 2.0 Flex 2014 em diante
AKT0038B	---	---	Flange de Combustível Fiat Mobi
AKT0040B	---	VP7160 - TSA030044	Flange de Combustível Nissan Sentra
AKT0041B	---	TSA030076	Flange de Combustível Peugeot
AKT0042B	---	---	Flange de Combustível Nissan Kicks
AKT0043B	---	VP7166 - TSA030073	Flange de Combustível Renault Kangoo
AKT0044B	---	---	Flange de Combustível Fiat Doblo
AKT0045B	---	---	Flange de Combustível Ford Ranger 2.3/2.5/2.8 16V Gasolina 97 até 2011 2.8/3.0 16V Diesel 97 até 2011 Ranger 4.0 V6 12V Gasolina 27 até 2011
AKT0046B	---	VP 7090	Flange de Combustível Renault Clio
AKT0047B	---	VP7167 - TSA030077	Flange de Combustível Fiat Linea
AKT0048B	---	VP7188/7187	Suporte do regulador de pressão Renault
AKT0049B	---	TSA040021	Suporte do regulador de pressão Nissan
AKT0050B	---	TSA 040022 - VP7076	Suporte do regulador de pressão Fiat
		---	Niple para Canister - Fiat Mobi



Sistema Bosch

Corsa todos >99/02 / Vectra todos 97> / S10 2.2 95>99 Blazer 2.2 >99 / Meriva e Zafira Todos Bocal 11 mm Gasolina



ASF0001

Sistema Bosch

Corsa todos >99/02 / Vectra todos 97> / S10 2.2 95>99 Blazer 2.2 >99 / Meriva e Zafira Todos bocal 11 mm Álcool



ASF0001A

Sistema Bosch

Kit ASSVE AKT0002B - AKT0008B Adaptações diversas Bocal "curto" 11 mm Gasolina



ASF0002

Sistema Bosch

Kit ASSVE AKT0002B - AKT0008B Adaptações diversas Bocal "curto" 11 mm Álcool



ASF0002A

Sistema Marwal Gasolina

Linha VW/Ford/Fiat / Escort / Verona / Gol / Parati / Pointer / Saniana / Quantum / Saveiro / Renault R19 Externo ou Primário

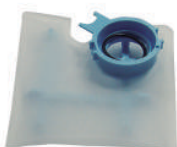

ASF0003

Sistema Marwal Álcool

Linha VW/Ford/Fiat / Escort / Verona / Gol / Parati / Pointer / Santana Quantum / Saveiro / Renault R19 Externo ou Primário



ASF0003A

Sistema Marwal Gasolina

Linha VW/Ford/Fiat / Escort / Verona / Gol / Parati / Pointer / Saniana / Quantum / Saveiro / Renault R19 Interno ou Secundário



ASF0004

Sistema Bosch

Montagem com Bomba de Combustível 0.580.453.966/069 Astra Imp. / Vectra / Corsa / Omega



ASF0005

Sistema Bosch

Fiesta 1.0i / 1.3i / 14i / 1.6i // KA 1.0 / 1.0i / 1.3i / 1.6i / Corolla 1.8i / 1.6i 16V Sedan Corolla Fielder 1.8i 16V Wagon



ASF0010

Sistema Bosch

Corsa todos >99/02 / Vectra todos 97> / S10 2.2 95>99 Blazer 2.2 >99 / Meriva e Zafira todos Bocal 11 mm FLEX Código Original F000TE1472



ASF0012



Sistema Delphi

Corsa 1.0/1.3/1.4 >96 Pick-up S10 2.2L IE 95 > 05/98
Espaçador e Tela Dupla



ASF0013



Sistema Delphi

Corsa 1.0/1.3/1.4 >96 Pick-up S10 2.2L IE 95 > 05/98
Espaçador e Tela Simples



ASF0014



Sistema Bosch Gasolina

Linha Ford/GM/Fiat/Mercedes-Benz - VW- Gol/Parati/Pointer/Santana/Quantum/
Saveiro/ Renault R19 Bomba de comb.Ref.Bosch no Sistema Marwal



ASF0018



Sistema Indebrás

Corsa todos
Blazer - S10 todos



ASF0020



Sistema Bosch

Linha Ford - KA/Fiesta Todos
Adaptação Linha Toyota Corolla



ASF0021



Sistema Delphi

Monza 90 > todos / Omega Suprema > 93 / Kadett EFI > 92 todos



ASF0022



Sistema Bosch

Kit ASSVE AKT0002B - AKT0008B
Adaptações diversas - Bocal "curto" 11 mm FLEX



ASF0023



Sistema Bosch

Courier 1.3i/1.4i/1.6i // Focus Sedan 1.6i 8V
Focus Sedan 1.8i 16V / 2.0i 16V



ASF0024



Sistema Marwal

Clio 00 > REF. 8200.058.355
Peugeot 206



ASF0025



Sistema Bosch (Externo)

Linhas Ford / VW / Fiat / GM / Toyota
Gasolina / FLEX



ASF0037



Sistema Bosch (Externo)

Linhas Ford / VW / Fiat / GM / Toyota - Flex
Com Espaçador Interno



ASF0037A



Sistema Bosch (Externo)

Linhas Audi / Chrysler / Fiat / VW



ASF0038



Sistema Bosch - Gasolina / Flex

Courier / EcoSport / EcoSport 2.0 Duratec / Fiesta / Supercharger / Focus / Meriva
Ref. Montagem 0.580.454.105



ASF0039 / ASF0040



Sistema Bosch (Interno)

Linhas Audi / Chrysler / Fiat / VW



ASF0041



Sistema Delphi

Blazer com motor 2.2L IE
ano 95>98



ASF0042



Sistema Delphi

Blazer V6 4.3L MPFI
Lado Externo do Copo



ASF0043



Sistema Bosch - Flex

Linha Ford/GM/Fiat/Mercedes-Benz - VW- Gol/Parati/Pointer/Santana/Quantum/
Saveiro/ Renault R19 Bomba de comb.Ref.Bosch no Sistema Marwal



ASF0044



Sistema Bosch (Externo)

Linhas Ford / VW / Fiat / GM / Toyota
Gasolina / FLEX



ASF0045



Sistema Bosch

REF. F000TE1257 Blazer / Corsa / Corsa Wagon



ASF0058



Sistema Marwal

Linha VW/Ford/ Fiat
Sistema Diesel - FLEX



ASF0120



Sistema Bosch

Linhas Ford / Citroen / Peugeot / Honda



ASF0122



Sistema Bosch

Linhas Ford / Citroen / Peugeot / Honda - flex

Pré-filtro com tela especial - desenvolvido visando maior durabilidade e a melhor adequação ao nosso combustível



ASF0122A



Sistema Bosch

Linhas Audi / Chrysler / Fiat / VW



ASF0129



Sistema Bosch (Externo)

FLEX Linhas VW / Fiat / Ford / GM / Toyota / Tucson



ASF0130



Sistema Bosch - (Externo)

Linhas Ford / VW / Fiat / GM / Toyota - Flex

Pré-filtro com espaçador interno e tela especial - desenvolvido visando maior durabilidade e a melhor adequação ao nosso combustível

Substitui o item ASF0130



ASF0130A



Sistema Bosch

Hyundai / Tucson Todos 2.0 ano 04>11

Gasolina / KIA Sportage 2.0 16 V Gasolina 04...



ASF0145



Sistema Bosch

Linhas Ford / GM / Peugeot / Honda / Chery / Fiat

Conjunto de pré-filtros interno e externo



ASF0200



Sistema Bosch

Linhas Ford / GM / Peugeot / Honda / Chery / Fiat / Citroen

Conjunto de pré-filtros interno e externo



ASF0201



Sistema Bosch

Linhas Ford / GM / VW / Toyota / Fiat

Conjunto de pré-filtros interno e externo

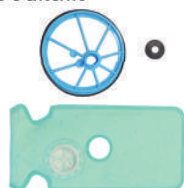

ASF0202



Sistema Bosch

Linha VW - CrossFox - Fox - SpaceFox

Conjunto de pré-filtros interno e externo



ASF0203



Sistema Bosch
Linhas VW / Fiat



ASF0204



Sistema Bosch
Linhas Fiat / Ford / GM / Toyota / VW



ASF0205



Spin 1.8 8V Flex 14>16



ASF0233A



Cobalt 1.4/1.8 8V 12>16
Cruze 1.8 16V 12>16
Onix 1.4 8V 14>16
Prisma 14>16
Todos Flex



ASF0233B



Ecosport 1.4/1.6/2.0 16V 14>
Fiesta 1.5/1.6 16V 13>
Ka 1.0 3C 12V 14>
Ka 1.5 4C 16V 13>
Todos Flex



ASF0234



Fiesta 1.6 16V 10>13 Flex
S10 2.4 8V 12>16 Flex
Trail 3.6 24V 12> Gasolina
Sentra 2.0 16V 09> Flex
Fluence 2.0 16V Flex 11>



ASF0235



Etios 1.3/1.5 16V Flex 13>18



ASF0238



Daewoo Matriz Pontiac G2 98>09 Gasolina



ASF0239



Jetta 1.8/2.0
Golf 1.6/1.8/2.0
Seat Ibiza 1.6
Gasolina >01

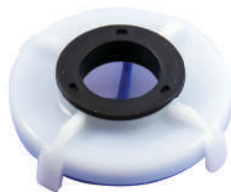

ASF0240



Audi A4/A6/A8 1.9/2.5
Passat / Golf / Bora 1.9
Peugeot 206/ 207 / 307 1.6
Diesel 01>10



ASF0241



Honda Motocross Fazer/CRF 250R 09>15
Kawasaki Ninja 650/Versys 650 07>14
Suzuki RMX 450Z 11>14 Todos Gasolina
Observação: Bocal 7mm



ASF0242



Ranger 4.0 V6 94>02
Explorer 4.0 V6 97>13
Gasolina



ASF0243



Ranger RZR Scrambler 570/800/850/900/1000 Gasolina 13>
Outlander L Max 450/500/570 Gasolina 15>



ASF0244



Kia Soul/Cerato 1.6 16V Flex 09>20



ASF0245



Toyota Hilux / Rav4 2.0/2.4 4x2 05>12 Gasolina



ASF0246



Hyundai Azzera 3.0 V6 24V a partir de 2012
Gasolina



ASF0247



Honda Moto Shadow 750 06>12
Dafra Moto Citycom 300i Todas Gasolina



ASF0248



Land Rover - Evoque 2.0 Turbo Gasolina 12>
Bocal de encaixe 90°



ASF0249



Land Rover Evoque 2.0 Turbo 12> Gasolina
Bocal de encaixe reto



ASF0250



BMW 135i / 220i / 228i / 320i Gasolina 11>19



ASF0251C



Honda Fit LX Hatch 1.4 8V
Fit LXL 1.4 8V
Fit EX 1.5 16V
Gasolina 04>08



ASF0251L



Ford Mondeo CLX / GLX Gasolina 95>00



ASF0252



Corolla XEI 1.8 16V Gasolina 96>00



ASF0253



Hyundai Santa Fé 2.4 / 3.3 / 3.5 24V 6C
Kia Sorento 2.4 / 3.3 / 3.5 24V 6C 09> Gasolina



ASF0254



Grand Caravan 3.3 / 3.8
Caravan 2.4 96>00
Gasolina



ASF0255



Citroen Xsara / Picasso 1.6/1.8/2.0 01>
Gasolina



ASF0256



Kia Sorento 2.4/3.3/3.5 24V 6C 07>09
Gasolina



ASF0257



Honda Civic Sedan EX/LX 1.6 16V 98>
Gasolina



ASF0258



Honda Fit
Substitui o ASF0251L



ASF0259



Honda Accord 2.0/2.4/3.0 V6 03>07
Gasolina



ASF0260



Mitsubishi Pajero TR4 2.0 16V / Pajero 1.0/1.8 16V
Todas Gasolina



ASF0261



Kia Cerato 1.6 16v
Gasolina 09>13



ASF0262



Ka 1.0/1.6 8V Flex 08>10
Citroen Aircross 1.6 16V Flex 10>15
GM Blazer 2.8 12V Diesel 05>09
Meriva 1.8 8V Flex 03>10



ASF0263



Sistema Marwal
Fiat Gasolina



ASF0264



Citroen C4 GLX/Hatch 1.6
C4 Pallas 2.0 / C5 2.0 16V todos Flex 08>14
Nissan March/Tiida/Livina/Versa/Kicks Flex



ASF0265



Honda Civic 1.7 4C 16V 01>
Gasolina



ASF0266



Gm Onix 1.0 4C 8V Flex 12>



ASF0267



Toyota Corolla 1.6/1.8 4C 16V 02>07
Gasolina



ASF0268



Ford Focus 1.6/2.0 4C 16V Flex 10>13
Honda City 1.5 4C 16V Flex 14>
Honda Fit 1.4/1.5 4C 16V Flex 14>



ASF0269



Hyundai I30 2.0 4C 16V
Gasolina 09>12



ASF0270



CÓDIGOS DUPARTS-ASSVE	CÓDIGO ORIGINAL	REFERÊNCIA CRUZADA	DESCRIÇÃO
ASF0001	F000TE9005	Cristal1816 - DS1301 - DSC3001	Montagem nas bombas 0.580.454.093/453.482
ASF0001A	---	---	Montagem nas bombas 0.580.454.113 - Álcool
ASF0002	---	---	Montagem nas bombas 0.580.454.093/453.482
ASF0002A	---	---	Montagem nas bombas 0.580.454.093/453.482 - Álcool
ASF0003	F000TE9007 MAM0020	Cristal1805 - DS1302 - DSC3002	Filtro Externo Sistema Marwal
ASF0003A	F000TE9008	Cristal1815 - DSC3014	Filtro Externo Sistema Marwal - Álcool
ASF0004	---	Cristal1876 - DS1316 - DSC3006	Filtro Interno Sistema Marwal
ASF0005	---	---	Montagem nas bombas 0.580.453.966/069
ASF0010	F000TE9006 F000TE1394	DS1328 - DSC3018	Montagem na bomba 0.580.454.094 / F000TE1276 Fiesta - Corolla
ASF0012	F000TE1472	Cristal1885 - DS1320 - DSC3010	Montagem nas bombas 0.580.454.113 - FLEX
ASF0013	125670023R	Cristal1810 - DS1305 - DSC3020	Montagem com bomba de comb. Sistema Delphi - Corsa
ASF0014	F000TE9001 6443600	Cristal1830 - DS1304 - DSC3021	Montagem com bomba de comb. Sistema Delphi - Corsa
ASF0018	F000TE1183	Cristal1874 - DS1315 - DSC3005	Montagem nas bombas 0.580.453.482/454.093/094
ASF0020	F000TE9002	Cristal1809 - DS1317 - DSC3007	Montagem nas bombas 0.580.453.481/454.093
ASF0021	861A9150AA	Cristal1875 - DS1313 - DSC3004	Linha Ford KA/Fiesta - Adaptação Toyota
ASF0022	90156970	Cristal1818 - DS1312 - DSC3003	Montagem com bomba BCD0101
ASF0023	---	---	Montagem nas bombas 0.580.454.093/453.482 - FLEX
ASF0024	F000TE1635 98AP9C358EB	Cristal1879	Montagem com bomba de combustível 0.580.454.093 Courier - Focus
ASF0025	Renault 8200058355	Cristal1033 - DS1318 - DSC3015	Montagem com bomba de combustível 8200.058.355 Clio / Peugeot
ASF0037	F000TE1511	DS1336	Linhas Ford / - VW - Fiat - GM - Toyota Montagem nas bombas 0.580.454.093/087/094/113
ASF0037A	ASF0037 para álcool	---	Montagem nas bombas 0.580.454.093/087/094/113 FLEX
ASF0038	F000TE1124	---	Montagem nas bombas 0.580.454.093/087/094/113
ASF0039/40	1582804037 0580454010	DS1323 - DS1324 - DSC3012	Montagem com bomba de combustível 0.580.454.105/113 Linha Ford - GM
ASF0041	F000TE138R	DS1338	Montagem nas bombas 0.580.454.093/087/113
ASF0042	GM25180047	Cristal1824 - DS1306	Sistema Delphi - Blazer 2.2
ASF0043	VDO12567002BR	Cristal1035 - DS1308	Sistema Delphi - Blazer V6
ASF0044	F000TE1547	Cristal1880 - DS1319 - DSC3009	Montagem nas bombas 0.580.454.113
ASF0045	0.580.454.008 0.580.454.066	DS1322 - DSC3008	Linhas Ford / - VW - Fiat - GM - Toyota Montagem nas bombas 0.580.454.093/087/094/113
ASF0058	F000TE1257	---	Sistema Bosch
ASF0120	Linha Diesel	---	Sistema Marwal - DIESEL
ASF0122	F000TE104A	DS1329 - DSC3016	Montagem nas bombas 0.580.454.113/125
ASF0122A	ASF0122 para álcool	---	Montagem nas bombas 0.580.454.113/125 FLEX
ASF0129	F000TE1124	DS1321 - DSC3011	Montagem nas bombas 0.580.454.093/087/094/113
ASF0130	F000TE100E	DS1333 - DSC3017	Montagem nas bombas 0.580.454.113/093/066
ASF0130A	ASF0130 para álcool	---	Montagem nas bombas 0.580.454.113/093/066 FLEX
ASF0145	311102E050 31110700	DS1344 - DSC3019	Hyundai - Tucson - KIA Sportage
ASF0200	F000TE104A	DS1341	Linhas Ford / GM / Peugeot / Honda / Chery / Fiat
ASF0201	F000TE104A	DS1339	Linhas Ford / GM / Peugeot / Honda / Chery / Fiat / Citroen
ASF0202	F000TE100E	DS1337	Linhas Ford / GM / VW / Toyota / Fiat
ASF0203	F000TE0127/128	DS1327	Linhas VW / Crossfox / Fox / Spacefox
ASF0204	F000TE0122/124	DS1326	Linhas Fiat / VW
ASF0205	F000TE100E	DS1340	Linhas Fiat / Ford / GM / Toyota / VW
ASF0233A	13.598.803	DS1335	Spin 1.4
ASF0233B	13598800 13598805	DS1334	Cobalt / Onix / Prisma
ASF0234	F000TE171V 0.580.454.113	DS1330	Fiesta / EcoSport / KA
ASF0235	F000TE120H AE839C3558AA	DS1332	Fiesta / Sentra / S10 / Fluence
ASF0238	2321-74010	---	Etios
ASF0239	---	---	Daewoo Matiz Pontiac G2 98 - 09
ASF0240	Bomba 357906092C	---	Jetta / Golf / Seat
ASF0241	Bombas 4B0906087BD 1525P3	---	Peugeot 206/207/307 Audi A4/A6/A8 Passat/Golf/Bora
ASF0242	Obs Moto Bocal 7mm	---	Honda MotoCross Fazer-CRF Kawasaki Ninja 650-Versys 650 - Suzuki RMX 450Z
ASF0243	Bomba Walbro	---	Ranger / Explorer
ASF0244	---	---	Ford Ranger Scrambler / Mitsubishi Outlander
ASF0245	3111025901R	---	KIA Soul - Cerato 1.6
ASF0246	Bomba Denso 29100	---	Toyota Rav4 / Hilux
ASF0247	---	---	Hyundai Azerra Gasolina
ASF0248	MOTO	---	Honda Moto Shadow 750 / Dafra Moto Citycom 300i
ASF0249	Bocal de encaixe 90° Branco	---	Land Rover Evoque 2.0 Turbo
ASF0250	Bocal de encaixe Reto Preto LRS57235-044427-026192	---	Land Rover Evoque
ASF0251C	---	---	BMW 320i/135i/220i/228i
ASF0251L	16010-SAA000	ASF0259 substitui	Honda FIT LX-LXL-EX
ASF0252	---	---	Ford Mondeo CLX-GLX
ASF0253	---	---	Toyota Corolla / Honda até 2000
ASF0254	31112-1R000	---	Hyundai Santa Fé / KIA Sorento
ASF0255	---	---	Chrysler Grand Caravan / Caravan 2.4
ASF0256	---	---	Citroen Xsara / Picasso
ASF0257	---	---	Kia Sorento
ASF0258	---	---	Honda Civic Sedan EX/LX
ASF0259	---	---	Honda FIT LX-LXL-EX
ASF0260	195130-XXX	---	Honda Accord 2.0/2.4/3.0
ASF0261	---	---	Mitsubishi Pajero TR4 - Pajero IO
ASF0262	---	---	Kia Cerato Gasolina
ASF0263	75559C358AA	DS1345 - Cristal1032 - Vogel20391	Ford - KA / Citroen AirCross / GM - Blazer - Meriva / HB20
ASF0264	---	---	Peugeot / Citroen / Nissan
ASF0265	MD211000PS MD211050PS	---	Citroen C4 - Pallas // Nissan - March - Tiida - Livina - Versa - Kicks
ASF0266	16010S5A932	DS1349	Honda Civic 1.7 4C 16V Gasolina até 2001
ASF0267	F000TE166S	DS1331	Onix 1.0 2010 até 2012
ASF0268	7702012770	DS1350	Toyota Corolla 2002 até 2007
ASF0269	0.580.314.572	DS1343	HR-V 1.8 Flex 2003 até 2015
ASF0270	311101H000	DS1347	Hyundai I30 2.0 2009 até 2012



Renault Clio 1.0 16V / Peugeot 206 1.0 16V

Nº Orig. 7.701.049.881/104374

Sistema Marelli - Bico injetor NºIWP099

Marelli

ASF0111



CONJUNTO
FLAUTA+
REPARO

ASF0009

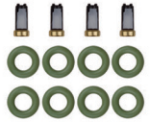

Corsa / Celta VHC 1.0 Gasolina

Nº Orig. 93.310.864 / 93.310.860 - Sistema Delphi

Bico Injetor Nº 25.314.927/25.313.300/25.319.301/ICD00111/112

Delphi

ASF0112



CONJUNTO
FLAUTA+
REPARO

ASF0011



Corsa / Celta 1.0 Flex / Corsa / Prisma / Meriva / Montana 1.4 Flex / Corsa / Prisma / Meriva / Montana 1.8 Flex

Nº Orig. 93.345.841/94.705.390/93.355.552/93.355.553

Sistema Delphi - Bico injetor Nº94.705.391/93.355.555/93.397.803/93.345.842

Delphi

ASF0113



CONJUNTO
FLAUTA+
REPARO

ASF0011



Prisma / Celta 1.4 / Corsa / Meriva / Montana 1.8 Gasol / Flex / Corsa / Celta 1.0 Flex

Nº Orig. 93.345.366/93.363.250/93.309.822/F000KV0220/F000KV0232

Sistema Bosch - Bico injetor Nº0.280.157.105/02.280.156.208/0.280.156.298/214

Bosch

ASF0116



CONJUNTO
FLAUTA+
REPARO

ASF0007

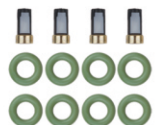

Clio / Scenic 1.6 16V Gasolina

Nº Orig. 8.200.139.674/00064100

Sistema Marelli - Bico injetor NºIWP143/179

Marelli

ASF0117



CONJUNTO
FLAUTA+
REPARO

ASF0009



Palio/Uno/Siena/Idea/Punto 8V

Nº Orig. CU12179/55.200.260

Sistema Marelli - Bico injetor NºIWP046/052/065

Marelli

ASF0136



CONJUNTO
FLAUTA+
REPARO

ASF0009

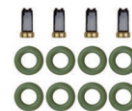

Fox/Space Fox/Gol G4-G5

Nº Orig. 030.133.329AA/030.133.319AP/030.133.329/GCV04701

Sistema Marelli - Bico injetor NºIWP176

Marelli

ASF0137

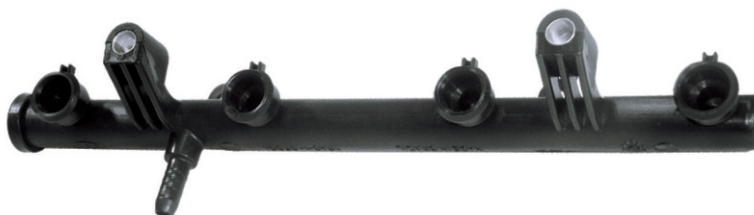

CONJUNTO
FLAUTA+
REPARO

ASF0016



S10/Blazer 2.4 Flex 07/11/Astra/Vectra 1.8/2.0 09/12

Nº Orig. 93.344.353/F000KV0233

Sistema Bosch - Bico injetor Nº0.280.156.086/0.280.155.929

Bosch

ASF0138



CONJUNTO
FLAUTA+
REPARO

ASF0007



Palio/Siena/Strada Weekend 1.0/1.3 16V

Nº Orig. F000KV0206/200/261

Sistema Bosch - Bico injetor Nº0.280.152.020

Bosch

ASF0139



CONJUNTO
FLAUTA+
REPARO

ASF0007

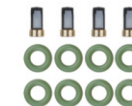

Renault/Logan/Sandero 1.0 16V a partir 2007

Nº Orig. 8.200.872.135/940.008.214

Sistema Bosch - Bico injetor Nº0.280.156.926/272

Bosch

ASF0166



CONJUNTO
FLAUTA+
REPARO

ASF0007



GM Astra 1.8 Gas.99/12/Zafira 2.0 Flex

Nº Orig. 93.275.195

Sistema Bosch - Bico Injetor Nº orig. 0.280.155.929/156.086

Bosch

ASF0195



CONJUNTO
FLAUTA+
REPARO



Celta 1.0 Flex 10/... Prisma 1.0 Flex 09/12

Nº Orig. 94.705.390/203.002.257

Sistema Delphi - Bico Injetor Nº orig. 93.362.611/94.705.391

Denso

ASF0196



CONJUNTO
FLAUTA+
REPARO



Onix/Prisma 1.4 Flex 13/19 / Cobalt 1.4 Flex 17/19

Nº Orig. 24.578.823

Sistema Delphi - Bico Injetor Nº orig. 24.578.820

Denso

ASF0197



CONJUNTO
FLAUTA+
REPARO



Doblo/Palio/Stilo/Strada/Idea 1.8

Nº Orig. 82.680.389/93.344.043

Sistema Delphi - Bico Injetor Nº orig. 93.397.803

Denso

ASF0198



CONJUNTO
FLAUTA+
REPARO



Doblo/Palio/Stilo/Strada/Idea 1.8

Nº Orig. 55.258.532/55.270.699/0.280.151.363

Sistema Bosch - Bico Injetor Nº orig. 0.280.157/153

Bosch

ASF0199



CONJUNTO
FLAUTA+
REPARO



Uno/Palio 1.0 Flex 10/... Palio/Punto 1.4 Flex 08/...
Nº Orig. 55.240.392 / 55233.619

Marelli
ASF0206



VW Gol / Polo / Golf 1.6 8V 05/08
Nº Orig. 030.133.319AF

Bosch
ASF0207



Renault Megane/Scenic 2.0 16V
Nº Orig. 8.200.601.367
Bico Injetor Nº Orig. H028797

Marelli
ASF0224



Renault Clio/Logan/Sandero/Symbol 1.6 8V
Nº Orig. 8.200.494.284A
Sistema Bosch - Bico Injetor Nº Orig. 0.280.157.132

Bosch
ASF0225



CÓDIGOS DUPARTS-ASSVE	REFERÊNCIA CRUZADA	CÓDIGOS DUPARTS-ASSVE	REFERÊNCIA CRUZADA	CÓDIGOS DUPARTS-ASSVE	REFERÊNCIA CRUZADA	CÓDIGOS DUPARTS-ASSVE	REFERÊNCIA CRUZADA
ASF0111	DSC 5050	ASF0136	DSC 5055	ASF0195	DSC 5060	ASF0206	DSC 5066
ASF0112	DSC 5051	ASF0137	DSC 5056	ASF0196	DSC 5062	ASF0207	DSC 5067
ASF0113	DSC 5052	ASF0138	DSC 5057	ASF0197	DSC 5063	ASF0224	DSC 5068
ASF0116	DSC 5053	ASF0139	DSC 5058	ASF0198	DSC 5064	ASF0225	DSC 5061
ASF0117	DSC 5054	ASF0166	DSC 5059	ASF0199	DSC 5065		

Liame do Trambulador



1101
Monza, Kadett e Ipanema
N° Original: 90.157.359
Código Similar: 9902



1102
Refil (sem haste)
Corsa e Celta
N° Original: 93.214.272
Código Similar: 9931



1103
Corsa e Celta
N° Original: 93.314.272
Código Similar: 9932

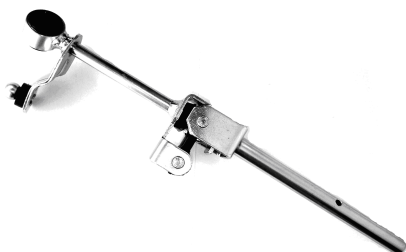

1105
Vectra 97/05
N° Original: 90.522.415
Código Similar: 9961



1107
Astra Importado
Vectra 94/05
N° Original: 90.578.987
Código Similar: 9982

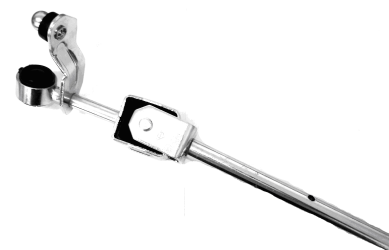

1109
Astra de 99/05
Corsa 04/... Celta 00/...
N° Original: 93.314.272
Código Similar: 9984

Ponta do Cabo Seletor de Marcha



3815
8mm
Palio, Siena, Stilo, Doblò



3813
10mm
Palio, Siena, Stilo, Doblò



3814
13mm
Palio, Siena, Stilo, Doblò



1101 - LIAME DO TRAMBULADOR
Monza - Kadett - Ipanema



1104 - LIAME DO TRAMBULADOR SEM HASTE
Vectra 94/96
Astra Importado
Calibra 94/96



1107 - LIAME DO TRAMBULADOR COM HASTE
Vectra 97/05



1110 - LIAME DO TRAMBULADOR SEM HASTE
Corsa 02/... (frente Montana)
Montana 04/... - Meriva 03/...



1113 - LIAME DO TRAMBULADOR COM HASTE (c/ coxim similar mod. original)
Corsa 02/... (frente Montana)
Montana 04/... - Meriva 03/...



2300 - TRAMBULADOR COMPLETO
Corsa - Celta - Vectra



Nº Orig. 93260525

1102 - LIAME DO TRAMBULADOR SEM HASTE
Corsa - Celta



1105 - LIAME DO TRAMBULADOR COM HASTE
Vectra 94/96
Astra Importado
Calibra 94/96



1108 - LIAME DO TRAMBULADOR SEM HASTE

Astra 99/05
Corsa Mod. Antigo
Celta



1111 - LIAME DO TRAMBULADOR COM HASTE
Corsa 02/... (frente Montana)
Montana 04/... - Meriva 03/...



Nº Orig. 90071931

1114 - KIT RETENTOR DO TRAMBULADOR + JUNTA DA TAMPA
Corsa - Celta (todos sistema a varão)



2301/1 - MANCAL DO TRAMBULADOR DA ALAVANCA C/ CABO
Corsa - Celta - Prisma
Montana - Zafira - Agile
Astra - Vectra - Classic



121

1103 - LIAME DO TRAMBULADOR COM HASTE
Corsa - Celta



1106 - LIAME DO TRAMBULADOR SEM HASTE
Vectra 97/05



1109 - LIAME DO TRAMBULADOR COM HASTE
Astra 99/05
Corsa Mod. Antigo
Celta



1112 - LIAME DO TRAMBULADOR SEM HASTE (c/ coxim similar mod. original)
Corsa 02/... (frente Montana)
Montana 04/... - Meriva 03/...



1115 - KIT RETENTOR DO TRAMBULADOR + JUNTA DA TAMPA
Monza - Kadett - Ipanema - Vectra 94/05



2301/2 - MANCAL DO TRAMBULADOR DA ALAVANCA C/ CABO
Corsa - Celta - Prisma
Montana - Zafira - Agile
Astra - Vectra - Classic



Nº Orig. 985001170/93347169

2302 - KIT REPARO DO TRAMBULADOR (antigo)

Celta - Corsa



2303 - KIT REPARO DO TRAMBULADOR (moderno)

Corsa - Montana
Meriva



2303/1 - KIT REPARO DO TRAMBULADOR (Liame Ferro)

Vectra - Astra - Zafira

LANÇAMENTO



2304 - ALAVANCA DE SELEÇÃO DO TRAMBULADOR

Corsa - Celta - Agile - Astra - Prisma - Vectra
Classic - Zafira - Montana

- Maior resistência
- Maior durabilidade

Novo Modelo c/ Bucha Guia

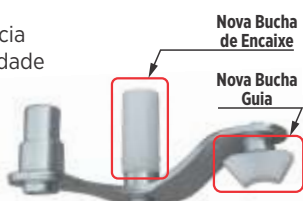

Nº Orig. 93.347.172

2305 - TERMINAL DO CABO DE ENGATE

Corsa - Celta - Prisma
Montana - Zafira - Agile
Astra - Vectra - Classic



Nº Orig. 93432176

2306 - KIT REPARO DO TRAMBULADOR

Corsa - Celta - Prisma - Montana - Zafira
Agile - Astra - Vectra - Classic



1 - 2301/1, 1 - 2304, 1 - 2305

2307 - KIT REPARO DO TRAMBULADOR

Corsa - Celta - Prisma - Montana - Zafira
Agile - Astra - Vectra - Classic



1 - 2301/2, 1 - 2304, 1 - 2305

2308 - KIT REPARO DO TRAMBULADOR

Corsa - Celta - Prisma - Montana - Zafira
Agile - Astra - Vectra - Classic



1 - 2301/2, 1 - 2309, 1 - 2305

2309 - ALAVANCA DE SELEÇÃO DO TRAMBULADOR

Corsa - Celta - Agile - Astra
Prisma - Vectra - Classic
Zafira - Montana

- Similar ao modelo original



Nº Orig. 93.347.172

2310 - EIXO PARCIAL DO TRAMBULADOR

Corsa - Celta - Agile - Astra - Prisma - Vectra
Classic - Zafira - Montana



Nº Orig. 24579439

2311 - PINO GUIA DO TRAMBULADOR

Aplicação Sistema Liame
Todos

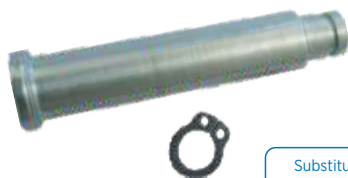

Substitui este pino

2312 - REPARO DO CABO DE COMANDO DE MARCHAS

Corsa - Celta - Agile - Astra - Prisma - Vectra
Classic - Zafira - Montana

Lado Trambulador



Detalhe do Kit montado



Nº Orig. 93306003

2313 - ALAVANCA DE SELEÇÃO DO TRAMBULADOR

Cobalt - Spin - Onix - Todos manual



Nº Orig. 24578948

2314 - REPARO DA ALAVANCA DO CÂMBIO COM PINO

Corsa - Celta - Agile - Astra - Prisma - Montana
Vectra - Classic - Zafira - Todos com sistema a cabo



122

Nº Orig. 93347157

2314/1 - REPARO PARCIAL DA ALAVANCA DO CÂMBIO SEM PINO

Corsa - Celta - Agile - Astra - Prisma - Montana
Vectra - Classic - Zafira - Todos com sistema a cabo



2315 - ARTICULADOR DE SELEÇÃO DE MARCHAS

Corsa - Celta - Agile - Astra - Prisma - Montana Vectra - Classic - Zafira - Todos com sistema a cabo



Nº Orig. 93345528

2318 - KIT REPARO DOS CABOS DE COMANDO DE MARCHA

Corsa - Celta - Prisma - Montana - Zafira Agile - Astra - Vectra - Classic



2321 - REPARO DO CABO DE COMANDO DE MARCHAS

Corsa - Celta - Agile - Astra - Prisma - Vectra Classic - Zafira - Montana

Lado Alavanca



2324 - BUCHA DO VARÃO DA ALAVANCA

Corsa - Celta - Vectra - Astra Todos com sistema de varão



2327 - KIT REPARO DA ALAVANCA

Corsa - Celta - Vectra - Astra Todos com sistema de varão



2316 - KIT ARTICULADOR DE SELEÇÃO DE MARCHAS

Corsa - Celta - Agile - Astra - Prisma - Montana Vectra - Classic - Zafira - Todos com sistema a cabo



2319 - PINO + BUCHA CONEXÃO DO CABO TRAMBULADOR

Corsa - Celta - Prisma - Montana - Zafira Agile - Astra - Vectra - Classic



2322 - ARTICULADOR DE SELEÇÃO DE MARCHAS

Vectra 05/... Astra 05/...

Furo Ø 17 mm



2325 - REPARO DA ARTICULAÇÃO INFERIOR

Corsa - Celta - Vectra - Astra Todos com sistema de varão



2328 - BUCHA REPARO DO CABO SELETOR

Captiva Câmbio Automático Todos



2317 - ARTICULADOR INFERIOR DA ALAVANCA DE CÂMBIO COM ANEL

Corsa - Celta - Vectra - Astra Todos com sistema de varão



Nº Orig. 90222571

2320 - BUCHA DO TRAMBULADOR

Vectra - Astra - Zafira - Todos Automáticos



2323 - KIT REPARO DO CABO

Corsa - Celta - Agile - Astra - Prisma - Vectra Classic - Zafira - Montana

Lado Alavanca

Lado Trambulador



2326 - KIT REPARO ARTICULAÇÃO INFERIOR

Corsa - Celta - Vectra - Astra Todos com sistema de varão



2329 - TERMINAL DO CABO DE ENGATE LADO ALAVANCA - Preto

Cobalt - Onix - Prisma Todos após 2013



2330 - TERMINAL DO CABO DE SELEÇÃO LADO ALAVANCA - Branco

Cobalt - Onix - Prisma
Todos após 2013



2331 - BUCHA INF. DA ALAVANCA DE CÂMBIO (Ré p/ trás)

Vectra - Astra - Zafira



2332 - BUCHA INFERIOR DA ALAVANCA DE CÂMBIO

Ômega - Suprema



2333 - SAPATA DO GARFO DA EMBREAGEM

S10 - Blazer - 94/11

O PAR!



2334 - PINO TRAVA DO TRAMBULADOR

GM - Sistema Liame todos



Nº Orig. 90.523.189

2335/1 - BUCHA C/ PINO TRAVA DO TRAMBULADOR

Corsa 02/... (frente Montana)
Montana 04/... - Meriva 03/...



Nº Orig. 90.523.189

2335/2 - BUCHA C/ PINO TRAVA DO TRAMBULADOR - Similar Original

Corsa 02/... (frente Montana)
Montana 04/... - Meriva 03/...



Nº Orig. 90.523.189

2336 - TAMPA DA CAIXA SELETORA DE MARCHAS

Corsa - Celta - Prisma - Astra - Sistema a cabo



Nº Orig. 24581783

2337 - REPARO DOS CABOS DE MARCHAS - Onix - Spin - Cobalt

Prisma todos 2013 /...
Todos câmbio manual



2338 - ARTICULADOR DE SELEÇÃO DE MARCHAS

Agile 10/14 - Montana 11/14
Alavanca Proema



2339 - KIT ARTICULADOR DE SELEÇÃO DE MARCHAS

Agile 10/14 - Montana 11/14
Alavanca Proema



2340 - BUCHA DO SUPORTE CENTRAL DO TRAMBULADOR

Corsa 02/... (frente Montana)
Montana 04/... - Meriva 03/...



Nº Orig. 97460287

2343 - ALAVANCA SELETORA DE TRANSMISSÃO - Corsa - Celta - Agile

Astra - Prisma - Montana - Vectra - Classic
Zafira - Todos com sistema a cabo



2344 - REPARO DA HASTE DO TRAMBULADOR

Monza - Kadett - Ipanema



2345 - PINO DO ARTICULADOR DO TRAMBULADOR

Corsa - Celta - Agile - Astra - Prisma - Vectra
Classic - Zafira - Montana



2346 - KIT REPARO DO CABO + PINO DO ARTICULADOR

Corsa - Celta - Agile - Astra - Prisma - Vectra Classic - Zafira - Montana



PEÇAS MONTADAS EM CONJUNTO NO VEÍCULO

2349 - REPARO DOS CABOS DE MARCHA - Lado Câmbio

Cobalt - Onix - Prisma - Spin
Todos 2013/...



2352 - KIT TERMINAL DOS CABOS DE ENGATE / SELEÇÃO

Celta - Corsa - Agile - Montana - Todos 2014/...



2355 - ALAVANCA SELETORA DA TRANSMISSÃO

Montana 09/12 - Agile 05/12



Nº Orig. 98500174

2358 - SUPORTE DO RADIADOR LADO DIREITO

Corsa 02/... (frente Montana)
Montana 04/... - Meriva 03/...



Nº Orig. 24422257

2347 - KIT DE MOLAS E TRAVAS DO EIXO DO TRAMBULADOR

Corsa - Celta - Agile - Astra - Prisma - Vectra Classic - Zafira - Montana



2350 - TERMINAL DO CABO DE SELEÇÃO

Celta - Corsa - Agile - Montana - Todos 2014/...



2353 - SUPORTE TRASEIRO DO MOTOR - Câmbio Manual

Astra 99/... - Vectra 06/12 - Zafira 01/...



Nº Orig. 90575233

2356 - KIT REPARO DO TRAMBULADOR - Corsa 02/... (frente Montana)

Montana 04/... - Meriva 03/...



Nº Orig. 94706824

2359 - KIT SUPORTE DO RADIADOR LE+LD

Corsa 02/... (frente Montana)
Montana 04/... - Meriva 03/...



Nº Orig. 09230984 / 93364981 / 024422257

2348 - KIT EIXO DO TRAMBULADOR C/ MOLAS E TRAVAS

Corsa - Celta - Agile - Astra - Prisma - Vectra Classic - Zafira - Montana



2351 - TERMINAL DO CABO DE ENGATE

Celta - Corsa - Agile - Montana - Todos 2014/...



2354 - ALAVANCA SELETORA DA TRANSMISSÃO

Cobalt - Onix - Novo Prisma - Celta - Agile Classic 12/14 - Montana 13/14



Nº Orig. 24579047

2357 - SUPORTE DO RADIADOR LADO ESQUERDO

Corsa 02/... (frente Montana)
Montana 04/... - Meriva 03/...



Nº Orig. 09230984 / 93364981

2360 - KIT SUPORTE DO RADIADOR LE+LD - Corsa 94/01 Sem Ar



Nº Orig. 90903946

**2361 - KIT SUPORTE DO RADIADOR
LE+LD - Corsa 94/01 Com Ar**



Nº Orig. 9046947JG

**2364 - KIT REPARO DO
TRAMBULADOR (antigo/moderno)**
Corsa - Celta - Montana - Meriva (todos varão)



**2367 - KIT SUPORTE DO RADIADOR
LE+LD**
Vectra 97/05



**2362 - KIT SUPORTE DO RADIADOR
LE+LD - Celta 01/16**



Nº Orig. 93260415

**2365 - KIT REPARO DO CABO
ENGATE/SELEÇÃO** - Onix 13/19
Spin 15/... - Cobalt 12/... - Montana 14/...



**2368 - TERMINAL DO CABO DE
ENGATE**
Onix Plus 2019/...



2363 - JUNTA TAMPA DE VÁLVULA
Corsa - Celta - Montana - Meriva
MOTORES 1.0 / 1.4 / 1.6 / 1.8 - TDS 8V



Nº Orig. 24579047

2366 - KIT REPARO DA ALAVANCA
Corsa 02/... (frente Montana)
Montana 04/... - Meriva 03/...



2210 - TIRANTE EXTERNO DO CÂMBIO - Curto

206 1.6 e 1.4 Todos



NOVO MODELO

Compatível c/ modelo 161 mm N° Orig. 2454.G5

2213 - TIRANTE EXTERNO DO CÂMBIO - Longo

206 1.0 todos - Partner 1.6 - Berlingo 1.6



Compatível c/ modelo 279 mm N° Orig. 2452.81

2216 - TIRANTE EXTERNO DO CÂMBIO - Curto

106



NOVO MODELO

Compatível c/ modelo 208 mm N° Orig. 2452.E1

2219 - KIT TIRANTE DO CÂMBIO UNIVERSAL

Peugeot - Citroen - Todos



NOVO MODELO

2250 - ALAVANCA SELETORA DO TRAMBULADOR

306 - Partner 1.8 - Berlingo 1.8 - Xsara 1.8



N° Orig. 2449.84 e 2449.86

2211 - TIRANTE EXTERNO DO CÂMBIO - Longo

206 1.6 e 1.4 Todos



Compatível c/ modelo 343 mm N° Orig. 2452.91

2214 - TIRANTE EXTERNO DO CÂMBIO - Curto

306 - Partner 1.8 - Berlingo 1.8 - Xsara 1.8



NOVO MODELO

Compatível c/ modelo 127,5 mm N° Orig. 2454.E6

2217 - TIRANTE EXTERNO DO CÂMBIO - Longo

106



2220 - TIRANTE EXTERNO DO CÂMBIO - Longo

Xsara Break 1.6



Compatível c/ modelo 250 mm N° Orig. 2452.79

2251 - ALAVANCA SELETORA DO TRAMBULADOR

206 1.4 e 1.6 Todos



N° Orig. 2449.89

2212 - TIRANTE EXTERNO DO CÂMBIO - Curto

206 1.0 Todos
Partner 1.6 - Berlingo 1.6



NOVO MODELO

Compatível c/ modelo 122 mm N° Orig. 2454.G4

2215 - TIRANTE EXTERNO DO CÂMBIO - Longo

306 - Partner 1.8 - Berlingo 1.8 - Xsara 1.8



Compatível c/ modelo 287 mm N° Orig. 2452.75

2218 - TIRANTE EXTERNO DO CÂMBIO - Curto com regulagem



206 1.0, 1.4 e 1.6 - 306
Xsara - Berlingo
Partner - 405 - ZX

NOVO MODELO

2221 - TIRANTE EXTERNO DO CÂMBIO - Curto

Xsara Picasso



Compatível c/ modelo 90 mm N° Orig. 2452.86

2252 - ALAVANCA SELETORA DO TRAMBULADOR

206 1.0 - Partner 1.6 - Berlingo 1.6



N° Orig. 2449.88

2253 - ALAVANCA SELETORA DO TRAMBULADOR

Xsara Break 1.6



Nº Orig. 2449.91

2254 - GARFO DE EMBREAGEM

Peugeot 206 1.4 1.6 Todos
106 - 205 - 306 motores 1.0 / 1.4 / 1.6
Citroen Xsara 1.6 16v - Citroen 1.4 8v



Nº Orig. 211756

2254/1 - KIT BUCHAS GARFO DA EMBREAGEM

Peugeot 206 1.4 1.6 Todos
106 - 205 - 306 motores 1.0 / 1.4 / 1.6
Citroen Xsara 1.6 16v - Citroen 1.4 8v



2254/2 - KIT GARFO DE EMBREAGEM + BUCHAS

Peugeot 206 1.4 1.6 Todos
106 - 205 - 306 motores 1.0 / 1.4 / 1.6
Citroen Xsara 1.6 16v - Citroen 1.4 8v



2255 - GARFO DE EMBREAGEM COMPLETO

Peugeot 206 1.4 1.6 todos 106 / 205 / 306
motores 1.0 - 1.4 - 1.6 - Citroen Xsara 1.6 16v
Citroen 1.4 8v



Nº Orig. 211756

2256 - GARFO DE EMBREAGEM

Peugeot 206 1.0 - Partner 1.6
Citroen Berlingo 1.6 - Picasso 2.0 16v



Nº Orig. 211758

2257 - GARFO DE EMBREAGEM

Peugeot 307 1.6 e 2.0
Citroen Picasso todos c/ Atuador
C4 1.4 / 1.6 / 2.0 - 16v



Nº Orig. 211766

2259 - GARFO DE EMBREAGEM

Peugeot 207 1.4 8v / 1.6 16v



Nº Orig. 211763

2260 - MOLA DE APOIO DA TRIZETA

Peugeot 106 - 205 - 206 - 207 - 306 - 307
Citroen C3 - C4 - Picasso - Xsara



Nº Orig. 3287.69

2260/1 - MOLA DE APOIO DA TRIZETA

Peugeot 306 - Partner - Berlingo - Xsara



Nº Orig. 3287.69

2261 - GARFO DE EMBREAGEM

Citroen C3 1.4 8v / 1.6 16v
Peugeot 307 1.6 16v



Nº Orig. 211761

2262 - REPARO DO CABO SELETOR

C3 Mec./Aut.
206 - 307 - C4 - Automático



128

2263 - GUIA DO ROLAMENTO DA EMBREAGEM

Peugeot 205 - 206 - 207 - 306 - 307
Citroen C3 - C4 - C5 - Picasso - Aircross
Xantia - Xsara - Berlingo



Nº Orig. 210535

2264 - GUIA DO ROLAMENTO DA EMBREAGEM

Peugeot 106 - 206 - 207 - 306 - 307 - Partner
Citroen C3 - Xsara - Aircross - Berlingo
Todos a partir de 06/.. Câmbio (MA)



Nº Orig. 210538

2266/1 - BUCHA DA CAIXA DA DIREÇÃO ELÉTRICA

Citroen C3 2013/... Peugeot 208



2269 - KIT REPARO DO PEDAL DA EMBREAGEM (Haste Trava Cabo+ Mola)

206 - 207 - Todos



Nº Orig. 2128.30 / 2148.55

2272 - COPO TAMPA FILTRO DE ÓLEO - Baixo - Peugeot - Citroen
(206 - 207 - 208 - C3 - C4... Diversos)



Nº Orig. 1103L7

2274/1 - SUPORTE SELETOR DO TRAMBULADOR + BUCHA + MOLA
Xsara Picasso 2.0 16V 02/...



2265 - JUNTA DO SUPORTE DO FILTRO DE ÓLEO

Peugeot 206 - 207 - 208 - 307 - 308 - Partner
Citroen C3 - C4 - Aircross - Picasso - Berlingo
Todos motores 1.4 8V / 1.6 16V



2267 - HASTE BIELETA DO PEDAL DA EMBREAGEM (Trava Cabo)

206 - 207 - Todos



Nº Orig. 2128.30

2270 - BUCHA INFERIOR DA ALAVANCA

106 - 206 - 306 - Partner - Berlingo - Xsara
Todos



2273 - COPO TAMPA FILTRO DE ÓLEO - Alto - Peugeot - Citroen
(206 - 207 208 - C3 - C4... Diversos)



Nº Orig. 1103J5

2275- KIT JUNTA RADIADOR ÓLEO
Peugeot 307/308/408
Citroen C4 /C5

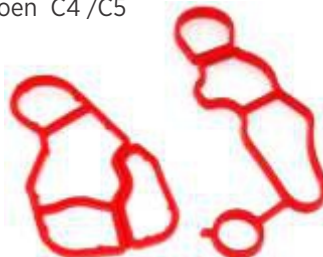

2266 - BUCHA DA CAIXA DA DIREÇÃO ELÉTRICA

Citroen C3 1.4 e 1.6 03/12



2268 - MOLA DO PEDAL DA EMBREAGEM

206 - 207 - Todos



Nº Orig. 2148.55

2271 - TERMINAL DO CABO DE ENGATE / SELEÇÃO

C3 - Aircross - 208
Todos com sistema
A15X - A19X



Nº Orig. 11124152261

2274 - SUPORTE SELETOR DO TRAMBULADOR + BUCHA
Xsara Picasso 2.0 16V 02/...



2276 - MOLA DA ALAVANCA SELETORA
Xsara Picasso 2.0 16V 02/...



2277 - KIT REPARO DA ALAVANCA
Citroen C3 02/12



2278 - BUCHA EIXO TRASEIRO
Eixo 47 mm - Peugeot 206 / 207

✓ **Elimina a folga**
✓ **Elimina o barulho**



2279 - KIT BUCHA EIXO TRASEIRO
Eixo 47 mm - Peugeot 206 / 207

✓ **Kit econômico**



2280 - BUCHA EIXO TRASEIRO
Eixo 50 mm - Peugeot 206 / 207

✓ **Elimina a folga**
✓ **Elimina o barulho**



2281 - KIT BUCHA EIXO TRASEIRO
Eixo 50 mm - Peugeot 206 / 207

✓ **Kit econômico**



2282 - PINO EIXO TRASEIRO COM PORCA - Freio a tambor
Peugeot 206 / 207 Todos



2283 - PINO EIXO TRASEIRO COM PORCA - Freio a disco
Peugeot 206 / 207 Todos



2284 - BUCHA DO EIXO TRASEIRO
Peugeot 306 - Citroen XSara - ZX



2285 - BUCHA DO CILINDRO ATUADOR PEDAL EMBREAGEM
Citroen C3 2013/... Aircross - DS3
Peugeot 207 / 208 / 307 / 308



LANÇAMENTO

Nº Orig. 9205839483938

5501 - PONTEIRA DE COMANDO DO CÂMBIO 10 mm

Palio - Siena - Strada



Nº Orig. 46784359TS

5502 - PONTEIRA DE COMANDO DO CÂMBIO 13 mm

Palio - Siena - Strada



Nº Orig. 46784358TE

5503 - HASTE DO TRAMBULADOR

Escort - Verona - Apollo



5504 - MOLA DA ALAVANCA DO CÂMBIO

Gol - Saveiro - Voyage - Fox (G5/...)



5505 - BUCHA DE REPARO DA ALAVANCA DE CÂMBIO

Gol - Saveiro - Voyage - Fox (G5/...)



5506 - KIT REPARO DA ALAVANCA DO CÂMBIO

Gol - Saveiro - Voyage - Fox (G5/...)



5507 - REPARO DA ALAVANCA DO CÂMBIO COM PINO

Punto 1.4 e 1.8



5508 - ARTICULADOR DE SELEÇÃO DE MARCHAS

Punto 1.4 e 1.8



5509 - KIT ARTICULADOR DE SELEÇÃO DE MARCHAS

Punto 1.4 e 1.8



5510 - GARFO DE ENGRENAGEM 1ª/2ª

Palio - Siena - Strada
Doblô - Marea
Brava - Uno - Tipo
Fiorino - Tempra



Nº Orig. 46750826

5511 - GARFO DE ENGRENAGEM 3ª/4ª

Palio - Siena - Strada
Doblô - Marea
Brava - Uno - Tipo
Fiorino - Tempra



Nº Orig. 46750827

5512 - GARFO DE ENGRENAGEM 5ª MARCHA

Clio - Megane - Logan
Scenic - Sandero



5513 - MOLA DO TRAMBULADOR RENAULT

Clio - Megane - Scenic - Laguna



5514 - GARFO DE ENGRENAGEM 1ª/2ª

Gol - Voyage - Parati
Saveiro
Motor AP 1.6 /
1.8 / 2.0 8V



5515 - GARFO DE ENGRENAGEM 3ª/4ª

Gol - Voyage - Parati
Saveiro
Motor AP 1.6 /
1.8 / 2.0 8V



5516 - BUCHA DA COLUNA DE DIREÇÃO

I30 - Veloster - Elantra - Kia Soul



5517 - PINO PEDAL DA EMBREAGEM

Fiesta - Ecosport



5518 - BUCHA DO TERMINAL DO CABO DE SELEÇÃO

Fiesta - Ecosport
KA - Focus



**NOVO MODELO
SIMILAR AO
MODELO ORIGINAL**

5519 - KIT REPARO DO TRAMBULADOR RENAULT

Clio - Megane - Scenic - Twingo - Kangoo
R19 - Laguna



5520 - KIT REPARO DO TRAMBULADOR RENAULT + MOLLA

Clio - Megane - Scenic - Twingo - Kangoo
R19 - Laguna



5521 - HASTE DA EMBREAGEM

Golf - Escort - Verona - Apollo
Todos 1.8 e 2.0



5522 - BUCHA DA HASTE DA EMBREAGEM

Golf - Escort - Verona - Apollo
Todos 1.8 e 2.0



5523 - ROLAMENTO DA EMBREAGEM

Golf - Escort - Verona - Apollo
Todos 1.8 e 2.0



5524 - KIT ACIONAMENTO DA EMBREAGEM

Golf - Escort - Verona - Apollo
Todos 1.8 e 2.0



5525 - KIT REPARO PARCIAL ALAVANCA CÂMBIO

Gol - Saveiro - Voyage - Fox (G5/...)



5525/1 - REPARO PARCIAL DA ALAVANCA C/ GUIA DE ENGATE

Gol - Saveiro - Voyage - Fox (G5/...)



5526 - KIT REPARO COMPLETO ALAVANCA CÂMBIO

Gol - Saveiro - Voyage - Fox (G5/...)



5526/1 - REPARO DA ALAVANCA DE CÂMBIO C/ BUCHA GUIA

Gol - Saveiro - Voyage - Fox (G5/...)



5526/2 - BUCHA GUIA DA ALAVANCA

Gol - Saveiro - Voyage - Fox (G5/...)
Golf - Bora - Polo - Audi A3



5526/3 - GUIA DE ENGATE DA ALAVANCA

Gol - Saveiro - Voyage - Fox (G5/...)



5527 - BUCHA REPARO CABO SELETOR
Fiat 500 Todos



5528 - REPARO DO CABO DE COMANDO DE MARCHAS
Punto 1.4 e 1.8 Todos



5529 - LIAME DO TRAMBULADOR
Mercedes Classe A 160 / 190



5530 - KIT REPARO DO TRAMBULADOR RENAULT
Logan - Sandero



5531 - BUCHA REPARO CABO SELETOR
Focus Automático



5532 - BUCHA DO PEDAL DA EMBREAGEM / FREIO
Fiesta - Ecosport - KA



Nº Orig. 25612461

5533 - CONEXÃO MANGUEIRA BLOCO COLETOR
Fiesta - Ecosport - Focus



5534 - ANEL DA TULIPA
Gol - Golf - Polo - Fox



5535 - SUPORTE DA ALAVANCA DO TRAMBULADOR
Gol - Saveiro - Voyage
Dox (G5/...)



Nº Orig. 6R0711202

5535/1 - SUPORTE DA ALAVANCA DO TRAMBULADOR



UP - todos manual

Nº Orig. 1S0711202B

5536 - BATENTE LIMITADOR DO PEDAL DA EMBREAGEM
Clio II



Nº Orig. 77.00.415.713

5537 - BUCHA DA CAIXA DE DIREÇÃO ELÉTRICA
Ford - New Fiesta - Nova Ecosport
Renault - Megane - Gran Tour 06/...



5538 - BUCHAS DA ALAVANCA
Palio - Siena - Doblo - Strada 02/...



5538/1 - REPARO DA ALAVANCA DE CÂMBIO
Palio - Siena - Doblo - Strada 02/...



5538/2 - REPARO PARCIAL DA ALAVANCA - Palio - Siena - Doblo
Strada 02/...



✓ **NOVA CONFIGURAÇÃO + Componentes pelo mesmo preço!**

**5539 - GARFO DE ENGRENAGEM
5ª MARCHA / RÉ**

Hyundai HR - H-100 - Motor HR 2.5
TCI após 2005



Nº Orig. 43862 4A001

**5540 - GARFO DE ENGRENAGEM
1ª/2ª**

Hyundai HR - H-100 - Motor HR 2.5
TCI após 2005



Nº Orig. 43841 4A001

**5541 - GARFO DE ENGRENAGEM
3ª/4ª**

Hyundai HR - H-100 - Motor HR 2.5
TCI após 2005



Nº Orig. 43861 4A001

**5542 - JUNÇÃO COM PINOS DO
VARÃO DO TRAMBULADOR**

Fiesta - KA - Courier - Até 2006



Nº Orig. 98FU7C453

**5543 - TERMINAL DO CABO
SELEÇÃO**

Fiesta - Ecosport - KA - Todos 2010/...



Nº Orig. AN157H401AA

**5543/1 - TERMINAL DO CABO DE
ENGATE**

Fiesta - Ecosport - KA - Todos 2010/...



Nº Orig. AN157H401BA

**5544 - KIT REPARO DOS CABOS
ENGATE / SELEÇÃO**

Fiesta - Ecosport - KA - Todos 2010/...



**5544/1 - KIT REPARO DOS CABOS
ENGATE / SELEÇÃO**

Fiesta - Ecosport - KA - Todos 2010/...



Nº Orig.
AN157H401AA / AN157H401BA

**5545 - BUCHA DA CAIXA DA
DIREÇÃO ELÉTRICA**

Hyundai 130 - Elantra - Kia Soul

Maior Durabilidade



Nº Orig. 56521-1H000

**5546 - BUCHA DA CAIXA DA
DIREÇÃO HIDRÁULICA**

Civic 01/06



**5547 - BUCHA DA CAIXA DA
DIREÇÃO**

Nissan Sentra - Tiida - Livina - Versa
Todos 07/...



**5548 - BUCHA DE CAIXA DA
DIREÇÃO**

Renault Clio II - Kangoo - Acima de 99/...



Nº Orig. 7700799093

**5549 - BUCHA DA ALAVANCA 4X4
REDUZIDA**

Mitsubishi L200 - Pajero - TR4



**5550 - JUNTA DE VEDAÇÃO DO
SUPORTE DO FILTRO DE ÓLEO**

Fiat todos motor Etorq - Jeep Renegade



5551 - FLANGE SEMI EIXO - Câmbio

Palio - Siena - Uno - Doblô - Marea - Strada
Argo



Nº Orig. 55263297

5552 - TUBO DA CARÇAÇA DA VÁLVULA TERMOSTÁTICA - Alumínio

Ford Ranger - Troller Motor 3.0



5553 - REPARO DA ALAVANCA DO CÂMBIO - Caixa EATON

Ranger 01/... - S10 01/... - Silverado 96/...
Frontier 02/...



Caixa EATON Fs02305 - Fs02405

5554 - TERMINAL DO CABO DE ENGATE

Golf 98/... - Bora 00/02 - Polo 00/...
A3 99/... - A4 98/... New Beetle 99/06



Nº Orig. 1J0711761A

5555 - ARTICULADOR DO CABO DE SELEÇÃO MARCHA RÉ

Golf 98/01 - Polo 96/00 - Passat Variant Importado - Seat



Nº Orig. 1J0.711256

5556 - KIT ALAVANCA DO CÂMBIO RENAULT

Clio - Megane - Scenic - Twingo Kangoo - R19 - Laguna



Nº Orig. 7700738263

5557- TERMINAL DO CABO DE ENGATE (10 mm)

Uno - Palio - Siena - Strada - Todos 2014/...



5558 - TERMINAL DO CABO DE SELEÇÃO (13 mm)

Uno - Palio - Siena - Strada - Todos 2014/...



5559- KIT REPARO TERMINAL DO CABO DE MARCHAS (Engate/Seleção)

Uno - Palio - Siena - Strada - Todos 2014/...



5560 - TERMINAL DO CABO DE ENGATE / SELEÇÃO

Gol - Fox - Polo - Saveiro (G5/...) Sistema a cabo



Nº Orig. 5Z0711761

5560/1 - KIT TERMINAL DO CABO DE ENGATE / SELEÇÃO

Gol - Fox - Polo - Saveiro (G5/...) Sistema a cabo



Nº Orig. 5Z0711761

5561 - TERMINAL DO CABO DE ENGATE - Furo 8 mm

Gol - Fox - Polo - Saveiro (G5/...)
Golf 01/... - Bora 05/...
UP - New Beetle 05/...
A3 99/...
A4 01/...



Furo: 8 mm

Nº Orig. 1J0711761C

5562 - TERMINAL DO CABO DE SELEÇÃO - Furo 10 mm

Gol - Fox - Polo - Saveiro (G5/...)
Golf 01/... - Bora 05/...
UP - New Beetle 05/...
A3 99/...
A4 01/...



Furo: 10 mm

Nº Orig. 1J0711761B

5563 - KIT TERMINAL DOS CABOS DE ENGATE / SELEÇÃO

Gol - Fox - Polo - Saveiro (G5/...)
Golf 01/... - Bora 05/...
UP - New Beetle 05/...
A3 99/...
A4 01/...



Furo: 8 mm

Furo: 10 mm

Nº Orig. 1J0711761C / 1J0711761B

5564 - KIT DE BUCHAS REPARO DO TRAMBULADOR - Contra Peso

Golf 94/98 - Polo Classic - Cordoba - Ibiza



5565 - BUCHA DO VARÃO DO TRAMBULADOR

Golf 94/98 - Polo Classic - Cordoba - Ibiza



5566 - KIT REPARO DO PEDAL DA EMBREAGEM - Catraca

Clio - Megane - Scenic 99/...



Nº Orig. 7700701597

5569 - MOLA DA ALAVANCA SELETORA

Fiesta - KA - Ecosport



5567 - TERMINAL DO CABO DE ENGATE

Fiesta - Ecosport - KA - Todos 02/10



Nº Orig. 2S657E395TR

5570 - MOLA DA ALAVANCA SELETORA

Focus 00/09 - Câmbio IB5



5568 - KIT REPARO DOS CABOS DE ENGATE / SELEÇÃO

Fiesta - Ecosport - KA - Todos 02/10



5571 - PIVÔ E MOLA GARFO EMBREAGEM

Gol - Fox - Bora - Voyage



5572 - KIT TRAVA DO CÂMBIO RENAULT (trava grossa)

Clio - Megane - Kangoo - Scenic



Nº Orig. 8200295074 (anel aberto)
Nº Orig. 7700720854 (anel fechado)

5572/1 - KIT TRAVA DO CÂMBIO RENAULT (trava fina)

Clio - Megane - Kangoo - Scenic



5573 - RETENTOR DO TRAMBULADOR RENAULT

Clio - Megane - Kangoo - Scenic



Nº Orig. 8201048885

5574 - BUCHA COLUNA DIREÇÃO Escamotiável

Golf - Bora - Fox - Polo - Jetta - Audi A3



Nº Orig. J0419578

5575 - REPARO TAMPÃO DE SELEÇÃO CÂMBIO I- MOTION

Gol - Polo - Voyage - Fox - Up - Spacefox

✓ **Elimina o vazamento de óleo**



5576 - HASTE DO TRAMBULADOR Curta

Golf 98/01 - Audi A4 98/01

Motor 1.6



Compatível c/ Modelo 105 mm

5577 - HASTE DO TRAMBULADOR Longa

Golf 98/01 - Audi A4 98/01

Motor 1.6



Compatível c/ Modelo 230 mm

5578 - KIT HASTE DO TRAMBULADOR

Golf 98/01 - Audi A4 98/01 - Motor 1.6



Compatível c/ Modelos 105 e 230 mm

5579 - REPARO DA ALAVANCA DO CÂMBIO

Golf 99/ - Bora - New Beetle - Audi A3



5580 - HASTE DO TRAMBULADOR
Sprinter 12/...



5581 - REPARO DA ALAVANCA
Fiesta - Ka - Courier - Escort - Todos sistema varão



5582 - BUCHA DO PEDAL DA EMBREAGEM / FREIO
Civic - Fit - HRV - CRV - City
Accord todos



Nº Orig. 46505-SA5-000

5583 - SUPORTE ARTICULADOR DO RETROVISOR
Amarok - todas



5584 - GUIA DE ROLAMENTO DE EMBREAGEM - 40 mm
Clio - Logan - Sandero - Scenic



5585 - GARFO DA EMBREAGEM
Clio - Logan - Sandero - Scenic



Nº Orig. 7700112818

5586 - BUCHA DA CAIXA DE DIREÇÃO (Coluna Elétrica)
Toyota Corolla .../12



5587 - REPARO DA ALAVANCA DO CÂMBIO
Escort - Verona 93/... - Logus - Pointer



5588 - CONEXÃO MANGUEIRA RADIADOR
Stilo 1.8 8V todos



Nº Orig. 51.714.542

5589 - SUPORTE SENSOR ROTAÇÃO
Palio - Siena - Strada 96/... todos 1.6 16V



Nº Orig. 46.462.157

5590 - BUCHA CAIXA DIREÇÃO ELÉTRICA
New Civic - Civic Si 10/11



5591 - BUCHA CAIXA DIREÇÃO ELÉTRICA
Honda Fit - City 09/14 - VW Fox 15/16
Caixa de Direção NSK



✓ **Maior vida útil**

5592 - KIT COXIM RADIADOR
Gol - Saveiro - Voyage - Fox (G5/G6)



Nº Orig. 6Q0121367A / 6QE121367

5593 - KIT SUPORTE DO COXIM DO RADIADOR
Gol - Saveiro - Voyage - Fox (G5/G6)



Nº Orig. 5Z0805757 / 5Z0805757B

5594 - KIT SUPORTE + COXIM DO RADIADOR
Gol - Saveiro - Voyage - Fox (G5/G6)



5595 - GARFO DE EMBREAGEM

HB20 1.0 12/20



Nº Orig. 41430-02700

5596 - KIT BUCHAS GARFO EMBREAGEM

HB20 1.0 12/20



Nº Orig. MF40117154

5597 - KIT GARFO DE EMBREAGEM COM BUCHAS

HB20 1.0 12/20



Nº Orig. 41430-02700 / MF40117154

5599 - BUCHA BATENTE SENSOR PEDAL FREIO / EMBREAGEM

Hyundai - KIA- JAC (Diversos)
Ford Fusion



5600 - BUCHAS FIXAÇÃO CAIXA DIREÇÃO - Amarak todas



✓ **Reforçada em PU**

5601 - BUCHAS FIXAÇÃO CAIXA DIREÇÃO

Hilux SRV / SW4 todas 05/...



5602 - BUCHAS FIXAÇÃO CAIXA DIREÇÃO

Chery Face 09/16



5603 - BUCHAS FIXAÇÃO CAIXA DIREÇÃO - Fiesta 03/12

Ecosport 04/12 - Courier



5604 - KIT BUCHAS GARFO EMBREAGEM (Base Plana)

Gran Siena - Uno - Fiat 500 - Palio



Nº Orig. 46543812 / 46543813

5605 - KIT BUCHAS GARFO EMBREAGEM (Base Chanfrada)

Fiat Argos - Cronos - Mobi - Palio Siena



Nº Orig. 46784963 / 46784964

5606 - KIT REPARO DA ALAVANCA UP 1.0 Todos Manual



5608 - BUCHA DO CABO DO ENGATE

Gol - Saveiro - Voyage - Fox (G5/...)



5609 - KIT REPARO DO CABO DE ENGATE /SELEÇÃO - C3 12/... Aircross

Peugeot 208 - Renault - Logan - Sandero Duster - Nissan Tiida - Versa - Sentra Todos caixa de câmbio A15X/A19X



2365 - KIT REPARO DO CABO ENGATE / SELEÇÃO

Focus 10/13



5613 - KIT REPARO DA ALAVANCA

Ecosport - Fiesta - KA - 2015/...



5616 - REPARO ALAVANCA

RENAULT - Logan - Sandero - Duster



Nº Orig. 770146411

5619 - KIT JUNTA DO RESFRIADOR + JUNTA SUPORTE FILTRO DE ÓLEO

Golf - Jetta - Passat - Tiguan
Audi A3/A4/A5/Q3/Q5



Nº Orig. 06J117070C / 06J115441A
Motores TSI / TFSI / CCZA / CDAA
/ CDNC / CCTA

5622 - BUCHA GUIA DO TRAMBUADOR

Gol - Saveiro - Voyage - Fox (G5/...) - Golf Bora - Polo - Audi A3



5611 - KIT REPARO DA ALAVANCA

Ecosport - Fiesta - KA - Todos até 2009



5614 - BUCHA DA HASTE CILINDRO EMBREAGEM

S10 - F250 - F350
F4000 98/... - Blazer 95/... - Ford Ranger Silverado 97/... - Explorer 95/97



Nº Orig. 93221087

5617 - SELO DO MOTOR

Honda Fit - City - Civic (Diversos)



Nº Orig. 12513p72003

5620 - GARFO DE EMBREAGEM C/ BUCHAS

Gran Siena 1.4/1.6 - Novo Palio 1.4/1.6
Doblo - Bravo - Fiat 500 - Palio
Sienna Todos 6 marchas



Nº Orig. 55250936

5623 - BUCHAS ALAVANCA

RENAULT
Honda Fit - City - Civic (Diversos)
Clio - Megane - Scenic - Logan - Sandero



139

5612 - KIT REPARO DA ALAVANCA

Ecosport - Fiesta - KA - 2010 a 2014



5615 - HASTE CILINDRO MESTRE EMBREAGEM

S10 - Blazer 95/... - Silverado 97/...



Nº Orig. 93348754

5618 - BUCHA DO CABO (Lado Alavanca)

Fiesta - KA
Ecosport (New)



5621 - BUCHAS DE FIXAÇÃO CAIXA DE DIREÇÃO

Frontier 2008/...



✓ Buchas reforçadas em PU

5625 - GARFO ENGRENAGEM 5ª MARCHA FORD

Ka - Fiesta - Ecosport
Focus - Courier
(Diversos)



Nº Orig. YS4Z7230BA
Todos os câmbios IB5 (Antigo/Moderno)

5626 - GARFO ENGRENAGEM
3ª/4ª HYUNDAI
HB20 1.0 3CC - Todos



5627 - KIT PARAFUSO COM BUCHA
GARFO EMBREAGEM
HB20 1.0 12/20



5628 - PINO ESFÉRICO DO SELETOR
(Contra Peso)
KA 2018/... Todos Câmbio MX65



5629 - JUNTA FILTRO DE ÓLEO
Todos Motores 1.6 THP (Mini - Peugeot
Citroen)



5630 - EXTENSOR Sonda LAMB.
UNIVERSAL



5631 - KIT REPARO PARCIAL
TRAMBULADOR RENAULT
Clio - Megane - Scenic - Twingo - Kangoo
R19 - Laguna



5632 - BUCHAS FIXAÇÃO CAIXA
DIREÇÃO
Mitsubishi L200 07/15



5633 - COXIM INFERIOR DO
RADIADOR
Logan - Sandero - Duster - Oroch



5634 - TERMINAL DO CABO
DE MARCHA
Gran Siena - Novo Palio



5635 - REPARO PARCIAL DA
ALAVANCA - Golf 99/... - Audi A3 99/05
Bora 01/07 - Polo 00/... - New Beetle 99/...



LANÇAMENTO

5636 - KIT REPARO DA ALAVANCA
Golf 99/... - Audi A3 99/05 - Bora 01/07
Polo 00/... - New Beetle 99/...



LANÇAMENTO

5637 - KIT REPARO COMPLETO DA
ALAVANCA - Golf 99/... - Audi A3 99/05
Bora 01/07 - Polo 00/... - New Beetle 99/...



LANÇAMENTO

5638 - REPARO DOS CABOS
SEL/ENG COM TRAVA
Golf 99/... - Audi A3 99/05 - Bora 01/07
Polo 00/... - New Beetle 99/...



LANÇAMENTO

5639 - EIXO DO TRAMBULADOR
Palio - Uno - Siena - Strada - Idea
Todos Motores Fire

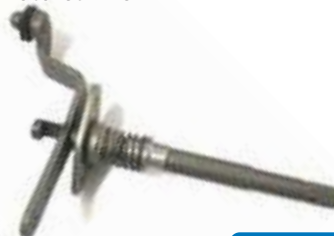

Nº Orig. 46428085 / 55217740

LANÇAMENTO

5640 - SELETOR DO
TRAMBULADOR (Contrapeso)
KA 2018/...



LANÇAMENTO

Nº Orig. H1BZ7210BF

5641 - KIT ALAVANCA SELETORA
KA 2018/...



LANÇAMENTO

Nº Orig. H1BZ7F116A

5644 - KIT PINO ESFÉRICO COM BUCHAS
KA 2018/...



LANÇAMENTO

5642 - BUCHA GUIA DO TRAMBULADOR (Par)
KA 2018/...



LANÇAMENTO

Nº Orig. 97ZT7C445AE

5646 - JUNTA COLETOR DE ADMISSÃO

Jetta - Passat - Golf - Tiguan
Audi A3 - A4 - A5 - Q3 - Q5
Motores VW 2.0 TSI / Audi 2.0 TFSI



LANÇAMENTO

5643 - BUCHA GUIA DO TRAMBULADOR (Unit.)
Fiesta - Ecosport - KA - Focus (Todos)



LANÇAMENTO

Nº Orig. 97ZT7C445AE

5647 - TAMPÃO RADIADOR FORD
Fiesta - Ecosport - KA - Focus (Todos)



LANÇAMENTO



ITENS	CÓDIGO	DESCRIÇÃO	APLICAÇÃO	ANO
	409.0033	Tirante externo do cambio 14,5cm	Uno 1.0/1.3/1.5 Elba 1.3/1.5 Fiorino 1.3/1.5 Premio 1.0/1.5	
	409.0034	Tirante externo do cambio 25,5cm	Uno 1.0/1.3/1.5 Elba 1.3/1.5 Fiorino 1.3/1.5 Premio 1.0/1.5	
	409.0029	Tirante externo do cambio 14cm	Uno 1.0/1.3/1.5 Elba 1.3/1.5 Fiorino 1.3/1.5 Premio 1.0/1.5	
	409.0030	Tirante externo do cambio 16cm	Uno 1.0/1.3/1.5 Elba 1.3/1.5 Fiorino 1.3/1.5 Premio 1.0/1.5	
	409.0031	Tirante externo do cambio 28cm	Uno 1.0/1.3/1.5 Elba 1.3/1.5 Fiorino 1.3/1.5 Premio 1.0/1.5	
	409.0032	Tirante externo do cambio 35 cm	Uno 1.0/1.3/1.5 Elba 1.3/1.5 Fiorino 1.3/1.5 Premio 1.0/1.5	



409.0021

Cupula
da alavanca
de cambio

corpo alto

Palio

Todos



409.0022

Cupula
da alavanca
de cambio

corpo baixo

Palio

Todos



109.0009

Reparo do
conjunto do
trambulador

04 Marchas

(Completo)
09 Peças

**Gol
Parati
Voyage
Saveiro
Passat
Santana**

**Todos
Todos
Todos
Todos
Todos
Todos**



109.0008

Reparo do
conjunto do
trambulador

05 Marchas
(com coifas)

07 Peças

**Gol
Parati
Saveiro
Passat
Santana
Voyage**

**94/07
94/07
94/07
95/...
95/...
95/...**



109.0010

Reparo do
conjunto do
trambulador

05 Marchas

(Completo)
11 Peças

**Gol
Parati
Saveiro
Passat
Santana
Voyage**

**94/07
94/07
94/07
95/...
95/...
95/...**



109.0018

Caixa rotula da alavanca de cambio

Gol
Voyage
Parati
Saveiro
Santana
Passat

.../04
.../04
.../04
.../04
.../04
.../04



109.0019

Caixa rotula da alavanca de cambio

Gol
Voyage
Parati
Saveiro
Santana

05/...
05/...
05/...
05/...
05/...



209.0013

Buchas do trambulador

Monza
Kadett

Todos
Todos



209.0014

Reparo do liame da alavanca de cambio

Monza
Kadett

Todos
Todos



ARRUELA ENCOSTO ROLAMENTO RODA SEDAM 10/74 38X20 N.OR. 113.405.661.1

NV-266



ARRUELA ENCOSTO ROLAMENTO RODA VW PASSAT, GOL ,QUANTUM,VOY,PARAT ,SEDAM 11/74 N.OR. 311.465.661

NV-267



BUCHA HASTE DE CÂMBIO UNO-ELBA-PREMIO- FIAT O.NR.5.939.762.

NV-379



RODA TRASEIRA GM NOVO CORSA HATCH-SEDAN N.OR.93.328.660

NV-275



Flexíveis de Freio

NORFLEX
FLEXÍVEIS PARA FREIOS



Código	Aplicação	Ano	D/T	Cód. Original	MM
F-7001	Fusca 1200/1300/1500/1600 Disco, Brasília, Karman Guia	Todos	T	113.611.775.3	270
F-7002	Fusca 1200/1300/1500 TL Karman Guia	.../75	D	113.611.701	480
F-7003	Fusca 1500, Saveiro, Voyage, Parati	79/...	T	303.611.775.1	300
F-7004	Kombi 1500 2 lados, 1600, Brasília - Kombi Diesel TE	73/...	T	113.611.775.2	285
F-7005	Fusca 1500/1600(D), Brasília Disco, Kombi 73/...	73/...	D	311.611.701.3	355
F-7005B	Kombi Disco 83, Brasília	83/...	D	311.611.701.3	355
F-7008	Gol, Passat, Saveiro	79/...	T	305.611.775.1	241
F-7010	Karman Ghia Lona 1300/1300L	76/81	D	311.611.701.1	442
F-7011	Kombi Luxo, Furgão (75/86) Pick-Up, Ambulância	.../82	D	211.611.701.2	445
F-7014	Kombi Cliper (D), Variant (T)	83/...	vide aplicação	311.611.701	370
F-7015	Kombi, VW 1600 Diesel	75/99	T/D	211.611.775.1	295
F-7015B	Kombi, 1600 Diesel	81/86	T/E	231.611.775.1	295
F-7016	Passat	74/...	D	ZBA 611.707	330
F-7017	Passat, Versailles, Santana, Quantum, Royale	84/...	T	ZBC 611.775	200
F-7018	Gol, Voyage, Santana, Quantum, Parati, Saveiro	79/...	D	305.611.707.1	350
F-7019	Fusca 1300, 1500, 1600, Kombi Disco(82), Variant 75/...	81/...	D	311.611.701A	380
F-7020	Variant II	77/...	D	301.611.707.1	410
F-7021	Variant II	77/...	T	301.611.775.1	245
F-7022	Gol, Parati, Saveiro	94/...	D	303.611.707	360
F-7023	Gol, Parati, Saveiro	94/...	T	377.611.775.B	215
F-7030	Polo, Golf	95/...	D	6K0611701	490
F-7031	Polo, Golf	95/...	T	6N06-11775-A	170
F-7035	Logus, Pointer	93/...	T	547611775A	440
F-7036	Logus, Pointer, Apollo	.../96	D	547611707	440
F-7039	Golf GTI/GL/GLX/GLM, Passat	.../...	T	1H0611701	190
F-7050	Golf	00/...	D	1J0611701	470
F-7052	Fox	05/...	D	6Q0611701F	550



Código	Aplicação	Ano	D/T	Cód. Original	mm
F-2001	Fiat 147, Panorama, Oggi City, Fiorino .../88	.../...	D	5.966.930-1	304
F-2002	Fiat 147, Panorama, Oggi City, Fiorino .../88	.../...	T	5.930.453-1	257
F-2003	Uno, Prêmio, Elba, Fiorino	88/92	D	5.954.603-1	380
F-2004	Uno, Prêmio, Elba, Fiorino	89/...	T	7.573.858	275
F-2005	Tempra, Tipo	92/...	T	7.706.859	430
F-2006	Tempra	92/...	D	7.730.632	445
F-2007	Palio, Strada, Siena, Marea, Brava	96/...	T	46.456.877	220
F-2008	Palio, Strada, Siena, Marea, Brava	96/...	D	46.448.474-1	500
F-2011	Tipo, Tempra Turbo, Tipo	95/...	T	7.730.632	450
F-2012	Tipo, Brava, Marea, Tempra	93/...	T	7.667.806	250
F-2013	Tipo	93/...	D	82.468.102	410
F-2014	Uno SX, SR e 1.5R	89/...	D	5.995.681	390
F-2015	Uno S e CS, Prêmio, Elba	.../85	D	7.725.169	400
F-2110	Palio Weekend	.../...	T	82.442.878	250
F-2111	Fiorino Fire	05/...	T	N/C	430
F-2112	Strada	.../...	D	N/C	400
F-2113	Idea	.../...	D	51.739.693	513
F-2114	Punto	.../...	D	51.763.160	445
F-2115	Punto	.../...	T	51.790.084	197
F-2116	Stilo	.../...	D	46.554.126	434
F-2117	Stilo Mangueira 1	.../...	T	46.809.897	305
F-2118	Stilo Mangueira 2	.../...	T	46.809.898	210





Flexíveis de Freio

NORFLEX
FLEXÍVEIS PARA FREIOS



Código	Aplicação	Ano	D/T	Cód. Original	mm
F-4002	Opala série 3100 e 3200, Veraneio e Caravan	76/...	T	3.696.551	460
F-4006	Chevette, Chevy	73/86	T	94.602.614	285
F-4009	Chevette 79 disco, Chevette 73/86		D	94.602.615	390
	A/C/D-10	80/...	T		
F-4011	Monza	.../...	T	N/C	230
F-4012	Monza, Kadett, Ipanema Freio a Disco	88/...	D	52.277.463	360
F-4013	Monza	.../87	D	90.147.349	360
F-4017	Monza, Kadett, Ipanema, Corsa, Pick-Up, Omega Suprema	88/...	T	90.235.999	231
F-4018	Opala, Caravan	80/92	D	94.609.698	660
F-4019	Opala, Caravan (Disco) 6 cil.	64/79	D	7.323.868	650
F-4020	Chevette, Chevy	87/...	D	94.651.667	390
F-4021	Chevette, Chevy	87/...	T	94.651.666	280
F-4031	Monza	82/87	T	90.121.718	230
F-4034	Omega, Suprema GLS e CD	93/...	D	90.445.764	459
F-4035	Omega, Suprema GLS e CD	93/...	T	90.235.999	240
F-4040	Corsa, Pick-up, Wind, Wagon, Sedan, Tigra	94/...	D	90.473.452	350
F-4041	Corsa/Pick-up (94/...), Monza s/ ABS (85/...), Kadett (92/95) Omega/Suprema (93/98), Tigra (98/...), Vectra (97/...) Calibra (89/94), Astra (95/96), Celta (01/...)	.../...	T	90.235.999	231
F-4046	Vectra	94/96	D	90.468.319	340
F-4060	S-10, Blazer	95/...	T	93.219.200	650
F-4070	Vectra, Astra 235mm (Importado)	97/05	T	90.445.758	235
				93.364.969	
F-4071	Vectra	97/99	D	90.495.787	440
F-4074	S-10, Blazer 97 2X4	95/...	D/D	93248636	585
F-4075	S-10, Blazer 97 2X4	95/...	D/E	93248637	585
F-4076	S-10, Blazer 4X4	97/...	D/D	93.275.024	590
F-4077	S-10, Blazer 4X4	97/...	D/E	93.275.023	590
F-4079	Astra	95/98	D	90.468.319	345
F-4081	Astra, Montana, Zafira	99/...	T	90.498.330	250
F-4082	Corsa, Montana	99/...	D	N/C	345
F-4083	Celta	01/04	D	93.364.971	360
F-4087	Monza, Kadett GS/GLS Freio a Disco nas 4 Rodas	.../...	---	52.267.770	198
F-4090	Astra	99/...	T	90.498.330	250
F-4100	Corsa Novo, Montana	09/...	D	9191262	325
F-4101	Corsa Novo, Montana	01/...	T	93.388.850	220
F-4102	Astra, Zafira, Vectra, Meriva	99/...	D	90.483.319	420
F-4103	Omega	99/...	T	92.057.158	240
F-4105	Omega	99/...	T/D	95.053.162	250





Flexíveis de Freio

NORFLEX
FLEXÍVEIS PARA FREIOS



Código	Aplicação	Ano	D/T	Cód. Original	mm
F-3003	Corcel, Belina, Del Rey, Pampa 4X2	69/77	D	80NU2078A	355
F-30033	Corcel, Del Rey (Todos)	77/...	D	77NU2078A	355
F-3004	Corcel, Belina, Del Rey, Pampa 4X2C	78/...	T	73MU2282A	406
F-3005	Escort, Verona, Apollo	84/...	D	84AU2078B	410
F-30055	Hobby	84/...	D	542.611.775	312
F-3006	Corcel, Del Rey, Belina, Pampa 4X2C	78/...	T	73 MU 2282 A	406
F-3007	Escort, Verona, Hobby, Apollo	84/...	T-E	84 AU 2282 A	305
F-30071	Escort, Verona, Hobby, Apollo	84/...	T-D	84 AU 2282 B	320
F-3008	Escort, Verona	93/94	T	547.611.7756A	440
F-3009	Escort, Verona	93/97	D	547.611.707	440
F-3010	F-1000 Freio a Disco	85/92	D-D	79TU2B171A	640
F-3011	F-1000 Freio a Disco	85/92	D-E	79TU2B218A	640
F-30110	F-1000 Direito	93/96	D-D	T71.607.183	525
F-30111	F-1000 Esquerdo	93/96	D-E	T71.607.183	525
F-3012	F-1000	.../...	T	BEOC 2282D	530
F-3024A	F-1000 (Intermediário)	93/96	vide aplicação	T71.607.306	480
F-3024B	F-1000/2000 (Intermediário) - Cilindro Mestre	.../92	vide aplicação	BEOC2A566B	300
F-3034	Fiesta	95/96	D-D	XC61.2078-CA	440
F-3035	Fiesta	95/96	D-E	XC61.2078-DA	440
F-3034C	Fiesta/ Courier (Flexível Melhorado)	96/...	D-D	N/C	375
F-3035C	Fiesta/ Courier (Flexível Melhorado)	96/...	D-E	N/C	375
F-3036	Fiesta	95/...	T	96FB.2282.CG	370
F-3040	Fiesta Importado	.../95	D	96FB.2078.DA	440
F-3042	Fiesta Importado	.../95	T	89FB.2282.AB	350
F-3046	Ka	97/...	D	97KB.2078.BB	540
F-3047	Ka	97/...	T	97KB/2282/AA	395
F-3050	Escort	97/...	D-D	95AB/2078/AD	400
F-3051	Escort	97/...	D-E	95AB/2078/BC	400
F-3052	Escort	97/...	T	95AB/2282/DB	330
F-3068	Ecosport 4X4	03/...	T	2N15/2282/BC	210
F-3080	Ranger	98/...	D/E	F87Z/2078/DA	290
F-3081	Ranger	98/...	D/D	F87A/2078/DA	335
F-3090	Fiesta Hatch/Sedan	02/...	D	2S65/2078/AD	570
F-3091	Fiesta Hatch/Sedan	02/...	T	2S65/2282/AC	370
F-3093	Fiesta Sedan	00/...	T	96FB/2982/AC	340
F-3094	Courier	99/...	T	98FU/2282/AB	430
F-3095	Ecosport 4X2	03/...	T	2N15/2282/AB	380
F-3096	Focus 1.4/ 1.6 Tambor	98/...	T	98AG/2282/AB	240
F-3098	Focus Hatch/Sedan	00/01	D	98AG/2078/AS	450
F-3100	Ecosport 4X2	03/...	D	N/C	590





Flexíveis de Freio

NORFLEX
FLEXÍVEIS PARA FREIOS

Citroën

Código	Aplicação	Ano	D/T	Cód. Original	MM
F-8001	Picasso Todos	98/...	D	N/C	480
F-8002	Picasso Todos	99/...	T	N/C	290
F-8003	C3	04/...	D	4806A9	480
F-8004	C3	04/...	T	4806A1	210

Honda

Código	Aplicação	Ano	D/T	Cód. Original	MM
F-4201	Civic	96/00	D/D	01468SR3902	450
F-4202	Civic	96/00	D/E	01466SR3903	450
F-4203	Civic	95/...	T	46430SR3031	278
F-4204	Civic	01/...	D/D	01464S5AJ02	580
F-4205	Civic	01/...	D/E	01465S5AJ02	580
F-4206	Civic	91/95	D/D	46410690	---
F-4207	Civic	91/95	D/E	46411690	---
F-4208	Fit	04/08	T/E	01468SAA000	300
F-4209	Fit	04/08	T/D	01466SAA000	300
F-4210	Fit Todos (com e sem ABS)	04/08	D/E	01464SADM00	555
F-4211	Fit Todos (com e sem ABS)	04/08	D/D	01465SADM00	555

Hyundai

Código	Aplicação	Ano	D/T	Cód. Original	MM
F-4801	Tucson	05/...	D	N/C	490
F-4802	Tucson	05/...	T	N/C	350

Mercedes-Benz

Código	Aplicação	Ano	D/T	Cód. Original	MM
F-5195	Classe A	98/...	T	A1684280235	360

Peugeot

Código	Aplicação	Ano	D/T	Cód. Original	MM
F-8115	Peugeot 206	98/...	D	480666	325
F-8116	Peugeot 206	98/...	T-E	480693	263
F-8117	Peugeot 206	98/...	T-D	480694	214

Renault

Código	Aplicação	Ano	D/T	Cód. Original	MM
F-8222	Clio	00/...	D	770.042.397.5	350
F-8223	Clio	98/...	T	770.400.392.2	280
F-8230	Megane, Scenic	98/...	D	N/C	425
F-8231	Megane, Scenic	98/...	T	770.083.486.3	310

Toyota

Código	Aplicação	Ano	D/T	Cód. Original	MM
F-6007	Corolla	.../02	D/D	9094702914	490
F-6008	Corolla	.../02	D/E	N/C	490
F-6013	Corolla XEI/XLI/SEG/GLI/WG	97/...	T	9094702921	330

D - Dianteiro (Direito e Esquerdo)	D-D - Dianteiro Direito	D-E - Dianteiro Esquerdo
T - Traseiro (Direito e Esquerdo)	T-D - Traseiro Direito	T-E - Traseiro Esquerdo





Cilindros de Roda

Tabela de Equivalência



FORTEC	TRW/Varga	BOSCH	ATE	Controil
CCR-9210	RCCR-0076.7	B-2299294	A-5903	C-3366.9
CCR-9213	RCCR-0139.0	B-2299167	A-5841	C-3356.1
CCR-9214	RCCR-0038.4	B-2262002	A-5345	C-3350.2
CCR-9219	RCCR-0001.5	-	-	C-3440.1
CCR-9220	-	B-2260905	-	C-3471.1
CCR-9221	RCCR-2329.5	B-2269875	A-5100	C-3375.8
CCR-9222	RCCR-2380.5	B-2269874	A-5102	C-3352.9
CCR-9223	-	-	-	-
CCR-9224	RCCR-0289.0	-	-	C-3500.9
CCR-9225	-	-	A-6098	C-3496.7
CCR-9226	RCCR-0288.0	-	A-5958	C-3472.0
CCR-9227	-	-	-	-
CCR-9228	-	-	-	C-3486.0
CCR-9229	RCCR-0199.0	B-2299291	A-5727	C-3437.1
CCR-9230	RCCR-0212.0	B-2261687	A-5780	C-3411.8
CCR-9231	RCCR-2345.7	-	A-5103	-
CCR-9232	RCCR-2398.8	-	-	C-3357.0
CCR-9233	RCCR-2157.8	B-2269851	A-5105	C-3351.0
CCR-9234	RCCR-2321.1	-	A-5105	C-3351.0
CCR-9235	RCCR-2156.1	B-2269873	A-5101	C-3407.0
CCR-9236	RCCR-0141.0	B-2258415	A-5744	C-3355.3
CCR-9237	RCCR-0089.9	B-2262230	A-5465	C-3404.5
CCR-9238	RCCR-0140.0	B-2262230	A-5760	C-3353.7
CCR-9239	RCCR-0196.0	B-2299157	A-6000	C-3413.4
CCR-9240	RCCR-0036.8	-	A-5515	C3397.9
CCR-9241	RCCR-0037.6	-	A-5514	C-3398.7
CCR-9242	-	B-2256921	-	-
CCR-9243	-	B-2256922	-	-
CCR-9244	RCCR-2473.9	-	-	-
CCR-9245	RCCR-2474.7	-	-	-
CCR-9246	-	B-2258252	A-5713	C-3358.8
CCR-9247	-	B-2258253	A-5714	C-3359.6
CCR-9248	RCCR-0010.4	-	-	-
CCR-9249	RCCR-0009.0	-	-	-
CCR-9250	RCCR-0084.8	-	-	C-3368.5
CCR-9256	RCCR-0094.5	B-2269858	A-5516	C-3360.0
CCR-9257	RCCR-0095.3	B-2269859	A-5516	C-3360.0
CCR-9258	RCCR-0128.3	-	A-6014	C-3412.6
CCR-9259	-	-	-	C-3438.0
CCR-9260	RCCR-0012.0	-	-	-
CCR-9261	RCCR-0011.2	-	-	-
CCR-9262	-	B-2257569	-	C-3459.2
CCR-9263	-	B-2257568	-	C-3458.4
CCR-9265	-	B-2259816	-	-
CCR-9266	RCCR-0191.0	B-2269858	A-5516	C-3439.8
CCR-9267	RCCR-0192.0	-	-	C-3462.2
CCR-9270	RCCR-0201.0	-	-	C-3470.3
CCR-9271	RCCR-0034.1	-	-	C-3468.1
CCR-9272	RCCR-0035.1	-	-	C-3469.0
CCR-9273	RCCR-2400.3	-	-	C-3395.2
CCR-9274	RCCR-2401.1	-	-	C-3396.0
CCR-9275	RCCR-0052.1	-	A-5519	C-3371.5
CCR-9276	RCCR-0053.8	-	A-5520	C-3372.3
CCR-9277	RCCR-0210.0	B-2258667	-	C-3354.5
CCR-9278	RCCR-2774.6	-	-	-
CCR-9279	RCCR-0138.0	B-229177	A-5795	C-3394.4
CCR-9280	RCCR-0015.5	B-2299178	A-6085	C-3373.1
CCR-9281	RCCR-0032.5	B-2269828	A-5302	C-3364.2
CCR-9282	RCCR-0033.3	B-2269829	A-5303	C-3365.0
CCR-9283	RCCR-0137.0	B-2269809	A-5821	C-3370.7
CCR-9284	RCCR-0136.0	B-2269808	A-5820	C-3369.3

FORTEC	TRW/Varga	BOSCH	ATE	Controil
CCR-9285	RCCR-0082.1	B-2269866	A-5448	C-3405.3
CCR-9286	RCCR-0083.1	B-2269867	A-5449	C-3406.1
CCR-9287	RCCR-0211.0	B-2259416	A-6086	C-3374.0
CCR-9288	RCCR-0204.0	B-2260699	A-6087	C-3408.8
CCR-9289	RCCR-0205.0	B-2260700	A-6088	C-3409.6
CCR-9290	RCCR-0130.5	B-2262754	A-6013	C-3410.0
CCR-9291	RCCR-0136.0	B-2299190	A-5820	C-3369.3
CCR-9292	RCCR-0137.0	B-2299191	A-5821	C-3370.7
CCR-9293	-	B-2258704	-	C-3446.0
CCR-9294	-	B-2258705	-	C-3447.9
CCR-9295	RCCR-0206.0	B-2260701	A-6089	C-3414.2
CCR-9296	RCCR-0207.0	B-2260702	A-6090	C-3415.0
CCR-92101	-	-	-	C-3450.9
CCR-92102	-	-	-	C-3451.7
CCR-92103	-	-	-	-
CCR-92104	-	-	-	C-3453.3
CCR-92105	-	-	-	C-3448.7
CCR-92106	-	-	-	C-3449.5
CCR-92107	-	-	-	-
CCR-92108	-	-	-	-
CCR-92113	RCCR-0239.0	-	-	C-3464.9
CCR-92114	RCCR-0240.0	-	-	C-3465.7
CCR-92118	RCCR-0291.0	-	-	C-3490.8
CCR-92122	RCCR-0146.0	B-2257186	-	C-3419.3
CCR-92123	RCCR-0147.0	B-2257187	-	C-3420.7
CCR-92127	-	-	-	-
CCR-92131	RCCR-0098.0	-	-	C-3466.5
CCR-92132	RCCR-0099.0	-	-	C3467.3
CCR-92133	RCCR-0002.3	B-2299204	-	C-3304.9
CCR-92144	RCCR-0124.0	B-2262057	-	C-3376.6
CCR-92145	RCCR-0125.9	B-2262058	-	C-3377.4
CCR-92150	RCCR-0144.0	B-2250765	-	C-3392.8
CCR-92151	RCCR-0145.0	B-2250766	-	C3393.6
CCR-92155	RCCR-0194.0	B-2259792	-	C-3306.5
CCR-92156	-	-	-	-
CCR-92157	-	-	-	-
CCR-92158	-	-	-	-
CCR-92159	-	-	-	-
CCR-92160	-	-	-	-
CCR-92161	-	B-2261459	-	C-3435.5
CCR-92162	-	B-2261460	-	C-3436.3
CCR-92163	-	B-2257188	-	C-3313.8
CCR-92164	-	B-2257189	-	C-3314.6
CCR-92169	RCCR-0142.0	B-2257924	-	C-3362.4
CCR-92179	-	-	-	C
CCR-92190	RCCR-0161.0	-	-	C-3484.3
CCR-92191	RCCR-0162.0	-	-	C-3485.1
CCR-92192	RCCR-0200.0	-	-	C-3491.6
CCR-92221	RCCR-0181.0	-	-	C-3481.9
CCR-92222	RCCR-0182.0	-	-	C-3482.7
CCR-92233	-	-	-	-
CCR-92234	-	-	-	-
CCR-92236	-	-	-	-
CCR-92237	-	-	-	-
CCR-92238	-	-	-	-
CCR-92241	-	-	-	-
CCR-92242	-	-	-	-
CCR-92243	-	-	-	-
CCR-92250	-	-	-	-
CCR-92252	-	-	-	-





Cilindros de Roda



Volkswagen

	Aplicação - VW		Ano	
	Kombi Clipper		81/...	
	Eixo	Lado	Pol. Ø	Pol. mm
	T	E/D	15/16"	23,81
Cód. Original				
V-RCCR-0076.7/ B-CR-9294				

	Aplicação - VW		Ano	
	Sedan 1300/ 1300L		76/...	
	Sedan 1500		76/82	
	Sedan 1600		10-70/...	
Karmann Ghia 1500		70/75		
Eixo	Lado	Pol. Ø	Pol. mm	
T	E/D	3/4"	19,05	
Cód. Original				
V-RCCR-2380.5/ B-CR-9874				

	Aplicação - VW		Ano	
	Saveiro/ Parati		82/...	
	Santana Aut./Quantum		86/...	
	Quantum Automático		96/98	
Golf G1 (México)		95/...		
Gol 2.0 (novo)/ Santana		95/...		
Eixo	Lado	Pol. Ø	Pol. mm	
T	E/D	11/16"	17,46	
Cód. Original				
V-RCCR-0139.0/ B-CR-2003				

	Aplicação - VW		Ano	
	Pólo (novo)/ Fox		2002/...	
	Golf		96/...	
Eixo	Lado	Pol. Ø	Pol. mm	
T	E/D	11/16"	17,46	
Cód. Original				
TRW/ FTE (alumínio)				

	Aplicação - VW		Ano	
	Gol/ Gol GTI		80/...	
	Passat		73/...	
	Voyage		82/...	
Santana		84/94		
Eixo	Lado	Pol. Ø	Pol. mm	
T	E/D	9/16"	14,29	
Cód. Original				
V-RCCR-0038.4/ B-CR-2002				

	Aplicação - VW		Ano	
	Brasília		73/76	
	TL/ TC/ Variant 1600		69/03-72	
Eixo	Lado	Pol. Ø	Pol. mm	
T	E/D	3/4"	19,05	
Cód. Original				
V-RCCR-2345.7				

	Aplicação - VW		Ano	
	Gol/ Parati (c/ ABS)		98/...	
	Golf GL/ Golf GLX		95/98	
	Parati (s/ ABS)		96/...	
Saveiro		82/86		
Saveiro (c/ ABS)		2000/...		
Pólo Classic		97/2001		
Eixo	Lado	Pol. Ø	Pol. mm	
T	E/D	3/4"	19,05	
Cód. Original				
V-RCCR-0001.5				

	Aplicação - VW		Ano	
	Brasília		77/...	
	SP1/ SP2		72/75	
	TL/ TC 1600		04-72/...	
Variant 1600		04-72/78		
Variant II		78/80		
Eixo	Lado	Pol. Ø	Pol. mm	
T	E/D	7/8"	22,22	
Cód. Original				
V-RCCR-2398.8				

	Aplicação - VW		Ano	
	Parati (sem ABS)		2001/...	
	Saveiro		96/...	
Eixo	Lado	Pol. Ø	Pol. mm	
T	E/D	13/16"	20,63	
Cód. Original				
B-226.0905				

	Aplicação - VW		Ano	
	Sedan/ Karman 1200		57/66	
	Sedan 1300/ 1300L		67/76	
Eixo	Lado	Pol. Ø	Pol. mm	
D	E/D	7/8"	22,22	
Cód. Original				
V-RCCR-2157.8/ B-CR-9851				

	Aplicação - VW		Ano	
	Sedan 1300/ 1300L		67/76	
	Sedan 1500		70/75	
	Sedan 1600		09-70/...	
Eixo	Lado	Pol. Ø	Pol. mm	
T	E/D	11/16"	17,46	
Cód. Original				
V-RCCR-2329.5/ B-CR-9875				

	Aplicação - VW		Ano	
	Sedan 1300/ 1300L		77/...	
	Sedan 1500		70/75	
Eixo	Lado	Pol. Ø	Pol. mm	
D	E/D	7/8"	22,22	
Cód. Original				
V-RCCR-2321.1				

	Aplicação - VW		Ano	
	Sedan/ Karman 1200		57/66	
	Sedan 1300L		67/76	
Eixo	Lado	Pol. Ø	Pol. mm	
T	E/D	3/4"	19,05	
Cód. Original				
V-RCCR-2156.1/ B-CR-9873				





Cilindros de Roda



	Aplicação - VW		Ano	
	Apollo		90/92	
	Eixo	Lado	Pol. Ø	Pol. mm
	T	E	11/16"	17,78
Cód. Original				
V-RCCR-0094.5/ B-CR-9858				

	Aplicação - FIAT		Ano	
	Ducato 1.8 toneladas		Todos	
	Eixo	Lado	Pol. Ø	Pol. mm
	T	E/D	1.1/8"	28,57
Cód. Original				

	Aplicação - VW		Ano	
	Apollo		90/92	
	Eixo	Lado	Pol. Ø	Pol. mm
	T	D	11/16"	17,78
Cód. Original				
V-RCCR-0095.3/ B-CR-9859				

	Aplicação - FIAT		Ano	
	Ducato 1.4 toneladas		Todos	
	Eixo	Lado	Pol. Ø	Pol. mm
	T	E/D	1.1/16"	27,00
Cód. Original				

	Aplicação - VW		Ano	
	Logus		93/...	
	Pointer		94/...	
	Eixo	Lado	Pol. Ø	Pol. mm
T	E/D	3/4"	19,05	
Cód. Original				
V-RCCR-0128.3				

	Aplicação - FIAT		Ano	
	Palio		04-96/08-98	
	Siena		97/08-98	
	Eixo	Lado	Pol. Ø	Pol. mm
T	E/D	3/4"	19,05	
Cód. Original				
A-5727/ V-RCCR-0199.0				

	Aplicação - VW		Ano	
	Logus		09-94/96	
	Pointer		94/96	
	Eixo	Lado	Pol. Ø	Pol. mm
T	E	3/4"	19,05	
Cód. Original				
B-226.1459				

	Aplicação - FIAT		Ano	
	Tempra		92/...	
	Uno Fiorino 1.0/1.5		04-93/...	
	Uno Turbo		93/...	
Strada		99/...		
Palio Weekend		97/...		
Brava/ Marea		2000/...		
Doblo		2001/...		
Stilo		2003/...		
Ideia		2006/...		
Eixo	Lado	Pol. Ø	Pol. mm	
T	E/D	13/16"	20,64	
Cód. Original				
A-5780/ V-RCCR-0001.5/ B-226.1687				

	Aplicação - VW		Ano	
	Logus		09-94/96	
	Pointer		94/96	
	Eixo	Lado	Pol. Ø	Pol. mm
T	D	3/4"	19,05	
Cód. Original				
B-226.1460				

	Aplicação - FIAT		Ano	
	147/ Spazio		76/87	
	Panorama/ Pick-Up		79/87	
	Oggi/ Fiorino		82/87	
Eixo	Lado	Pol. Ø	Pol. mm	
T	E/D	3/4"	19,05	
Cód. Original				
A-5744/ V-RCCR-0141.0/ B-225.8415				



	Aplicação - FIAT		Ano	
	Siena		2001/...	
	Eixo	Lado	Pol. Ø	Pol. mm
	T	E/D	13/16"	20,64
Cód. Original				
A-6098 (alumínio)				

	Aplicação - FIAT		Ano	
	Uno 1.5 R/ 1.6 R		87/...	
	Eixo	Lado	Pol. Ø	Pol. mm
	T	E/D	11/16"	17,46
Cód. Original				
A-5465/ RCCR-0089.9				

	Aplicação - FIAT		Ano	
	Palio		09-98/...	
	Siena		09-98/2000	
	Eixo	Lado	Pol. Ø	Pol. mm
T	E/D	3/4"	19,05	
Cód. Original				
A-5958/ V-RCCR-0288.0 (alumínio)				







Cilindros de Roda



	Aplicação - FIAT		Ano	
	Uno/ Elba/ Prêmio		84/...	
	Fiorino/ Pick-Up		88/...	
	Eixo	Lado	Pol. Ø	Pol. mm
T	E/D	3/4"	19,05	
Cód. Original				
A-5760/ V-RCCR-0140.0				

	Aplicação - FORD		Ano	
	Del Rey/ Scala		81/...	
	Corcel II/ Belina II		09-79/...	
	Eixo	Lado	Pol. Ø	Pol. mm
T	D	3/4"	19,05	
Cód. Original				
V-RCCR-0037.6				

	Aplicação - FIAT		Ano	
	Tipo		93/...	
	Eixo	Lado	Pol. Ø	Pol. mm
	T	E/D	---	22,00
Cód. Original				
B-229.9157/ RCCR-0196.0				

	Aplicação - FORD		Ano	
	Corcel		69/09-77	
	Eixo	Lado	Pol. Ø	Pol. mm
	T	E	5/8"	15,87
Cód. Original				
B-225.6921				





	Aplicação - FORD		Ano	
	Royale/ Versailles Aut.		91/...	
	Versailles		94/...	
	Eixo	Lado	Pol. Ø	Pol. mm
T	E/D	11/16"	17,46	
Cód. Original				
V-RCCR-0139.0/ B-CR-2003				

	Aplicação - FORD		Ano	
	Corcel		69/09-77	
	Eixo	Lado	Pol. Ø	Pol. mm
	T	D	5/8"	15,87
Cód. Original				
B-225.6922				

	Aplicação - FORD		Ano	
	Versailles		91/94	
	Eixo	Lado	Pol. Ø	Pol. mm
	T	E/D	9/16"	14,29
Cód. Original				
V-RCCR-0038.4/ B-CR-2002				

	Aplicação - FORD		Ano	
	Corcel		73/77	
	Eixo	Lado	Pol. Ø	Pol. mm
	T	E	5/8"	15,87
Cód. Original				
V-RCCR-2473.9				

	Aplicação - FORD		Ano	
	Fiesta 1.0/1.4/1.6 (novo-c/ ABS)		05-2002/...	
	Fiesta Sedan		2005/...	
	Ecosport		2003/...	
Eixo	Lado	Pol. Ø	Pol. mm	
T	E/D	13/16"	20,64	
Cód. Original				
A-6098 (alumínio)				

	Aplicação - FORD		Ano	
	Corcel		73/77	
	Eixo	Lado	Pol. Ø	Pol. mm
	T	D	5/8"	15,87
Cód. Original				
V-RCCR-2474.7				

	Aplicação - FORD		Ano	
	Fiesta 1.0 NA (novo-s/ ABS)		05-2002/...	
	Eixo	Lado	Pol. Ø	Pol. mm
	T	E/D	3/4"	19,05
Cód. Original				
A-5958/ V-RCCR-0288.0 (alumínio)				

	Aplicação - FORD		Ano	
	Belina		69/09-77	
	Del Rey		81/91	
	Corcel II/ Belina II		10-77/...	
Eixo	Lado	Pol. Ø	Pol. mm	
T	E	3/4"	19,05	
Cód. Original				
B-225.8252				

	Aplicação - FORD		Ano	
	Del Rey/ Scala		81/...	
	Corcel II/ Belina II		09-79/...	
	Eixo	Lado	Pol. Ø	Pol. mm
T	E	3/4"	19,05	
Cód. Original				
V-RCCR-0036.8				

	Aplicação - FORD		Ano	
	Belina		69/09-77	
	Del Rey		81/91	
	Corcel II/ Belina II		10-77/...	
Eixo	Lado	Pol. Ø	Pol. mm	
T	D	3/4"	19,05	
Cód. Original				
B-225.8253				







Cilindros de Roda





	Aplicação - FORD		Ano	
	Belina II		07-77/08-79	
	Eixo	Lado	Pol. Ø	Pol. mm
	T	D	7/8"	22,22
Cód. Original				
V-RCCR-0010.4				

	Aplicação - FORD		Ano	
	Corcel II		07-77/08-79	
	Eixo	Lado	Pol. Ø	Pol. mm
	T	D	13/16"	20,64
Cód. Original				
V-RCCR-0012.0				

	Aplicação - FORD		Ano	
	Belina II		07-77/08-79	
	Eixo	Lado	Pol. Ø	Pol. mm
	T	E	7/8"	22,22
Cód. Original				
V-RCCR-0009.0				

	Aplicação - FORD		Ano	
	Corcel II		07-77/08-79	
	Eixo	Lado	Pol. Ø	Pol. mm
	T	E	13/16"	20,64
Cód. Original				
V-RCCR-0011.2				

	Aplicação - FORD		Ano	
	Pampa		82/...	
	Eixo	Lado	Pol. Ø	Pol. mm
	T	E/D	3/4"	19,05
Cód. Original				
V-RCCR-0084.8				

	Aplicação - FORD		Ano	
	Pampa 4x4		84/...	
	Eixo	Lado	Pol. Ø	Pol. mm
	T	D	13/16"	20,64
Cód. Original				
B-225.7569				

	Aplicação - FORD		Ano	
	Escort		83/10-92	
	Verona		90/92	
	Hobby		93/...	
	Eixo	Lado	Pol. Ø	Pol. mm
	T	E	11/16"	17,78
Cód. Original				
V-RCCR-0094.5/ B-CR-9858				

	Aplicação - FORD		Ano	
	Pampa 4x4		84/...	
	Eixo	Lado	Pol. Ø	Pol. mm
	T	E	13/16"	20,64
Cód. Original				
B-225.7568				

	Aplicação - FORD		Ano	
	Escort		83/10-92	
	Verona		90/92	
	Hobby		93/...	
	Eixo	Lado	Pol. Ø	Pol. mm
	T	D	11/16"	17,78
Cód. Original				
V-RCCR-0095.3/ B-CR-9859				

	Aplicação - FORD		Ano	
	Belina 4x4		84/...	
	Eixo	Lado	Pol. Ø	Pol. mm
	T	E	3/4"	19,05
Cód. Original				
B-225.9815				

	Aplicação - FORD		Ano	
	Escort		11-92/96	
	Verona		11-93/96	
	Fiesta 1.4/ 1.6		96/...	
	Ka 1.6		2001/...	
	Eixo	Lado	Pol. Ø	Pol. mm
T	E/D	3/4"	19,05	
Cód. Original				
V-RCCR-0128.3				

	Aplicação - FORD		Ano	
	Belina 4x4		84/...	
	Eixo	Lado	Pol. Ø	Pol. mm
	T	D	3/4"	19,05
Cód. Original				
B-225.9816				

	Aplicação - FORD		Ano	
	Fiesta (importado)		94/95	
	Eixo	Lado	Pol. Ø	Pol. mm
	T	E/D	---	19,00
Cód. Original				
F-711.7257				

	Aplicação - FORD		Ano	
	Fiesta 1.0/ 1.3		96/...	
	Ka 1.0/ 1.3		97/...	
	Eixo	Lado	Pol. Ø	Pol. mm
T	E/D	11/16"	17,78	
Cód. Original				
V-RCCR-0191-0				

	Aplicação - FORD		Ano	
	Escort 16v/ SW/ Sedan/ Diesel		97/...	
	Focus		2001/...	
	Eixo	Lado	Pol. Ø	Pol. mm
	T	E/D	13/16"	20,64
	Cód. Original			
V-RCCR-0192.0				







Cilindros de Roda



	Aplicação - FORD		Ano	
	Courier		98/...	
	Mondeo SW		94/...	
	Ecosport 4x4		2003/...	
Eixo	Lado	Pol. Ø	Pol. mm	
T	E/D	7/8"	22,22	
Cód. Original				
V-RCCR-0201.0				

	Aplicação - FORD		Ano	
	Escort		09-94/97	
	Verona		09-94/96	
	Eixo	Lado	Pol. Ø	Pol. mm
T	E	3/4"	19,05	
Cód. Original				
B-226.1459				

	Aplicação - FORD		Ano		
	Ranger 4x2/ 4x4 (tambor 10")		98/...		
	Eixo	Lado	Pol. Ø	Pol. mm	
	T	E/D	13/16"	20,64	
Cód. Original					
1L5Z-2261-GA					

	Aplicação - FORD		Ano	
	Escort		09-94/97	
	Verona		09-94/96	
	Eixo	Lado	Pol. Ø	Pol. mm
T	D	3/4"	19,05	
Cód. Original				
B-226.1460				

	Aplicação - FORD		Ano		
	Ranger (tambor 10")		94		
	Eixo	Lado	Pol. Ø	Pol. mm	
	T	E/D	13/16"	20,64	
Cód. Original					
E9TZ-2261-A					





	Aplicação - GM		Ano	
	Celta		08-2002/...	
	Prisma		2007/...	
	Eixo	Lado	Pol. Ø	Pol. mm
T	E/D	9/16"	14,29	
Cód. Original				
V-RCCR-0289.0				

	Aplicação - FORD		Ano		
	Ranger (tambor 10")		95		
	Eixo	Lado	Pol. Ø	Pol. mm	
	T	E/D	3/4"	19,05	
Cód. Original					
F57Z-2261-A					

	Aplicação - GM		Ano		
	Celta		00/07-02		
	Eixo	Lado	Pol. Ø	Pol. mm	
	T	E/D	11/16"	17,78	
Cód. Original					
V-RCCR-0191-0					

	Aplicação - FORD		Ano		
	Ranger (tambor 11")		96/...		
	Eixo	Lado	Pol. Ø	Pol. mm	
	T	E/D	13/16"	20,64	
Cód. Original					
F87A-2261-AA					

	Aplicação - GM		Ano		
	Opala/ Caravan		79/80		
	Eixo	Lado	Pol. Ø	Pol. mm	
	T	E	3/4"	19,05	
Cód. Original					
V-RCCR-0034.1					

	Aplicação - FORD		Ano		
	Ranger (tambor 9")		94/95		
	Eixo	Lado	Pol. Ø	Pol. mm	
	T	E/D	3/4"	19,05	
Cód. Original					
E3TZ-2261-B					

	Aplicação - GM		Ano		
	Opala/ Caravan		79/80		
	Eixo	Lado	Pol. Ø	Pol. mm	
	T	D	3/4"	19,05	
Cód. Original					
V-RCCR-0035.1					

	Aplicação - FORD		Ano		
	Explorer (tambor 9")		92/94		
	Eixo	Lado	Pol. Ø	Pol. mm	
	T	E/D	7/8"	22,22	
Cód. Original					
E99Z-2261-A					

	Aplicação - GM		Ano	
	Opala (todos)		71/78	
	Caravan		75/78	
	Eixo	Lado	Pol. Ø	Pol. mm
T	E	3/4"	19,05	
Cód. Original				
V-RCCR-2400.3				







Cilindros de Roda





	Aplicação - GM		Ano	
	Opala (todos)		71/78	
	Caravan		75/78	
	Eixo	Lado	Pol. Ø	Pol. mm
T	D	3/4"	19,05	
Cód. Original				
V-RCCR-2401.1				

	Aplicação - GM		Ano	
	Monza		82/87	
	Eixo	Lado	Pol. Ø	Pol. mm
	T	D	3/4"	19,05
Cód. Original				
A-5303/ V-RCCR-0033.3				

	Aplicação - GM		Ano	
	Opala/ Caravan		81/...	
	Eixo	Lado	Pol. Ø	Pol. mm
	T	E	7/8"	22,22
Cód. Original				
V-RCCR-0052.1				

	Aplicação - GM		Ano	
	Monza/ Ipanema		88/...	
	Eixo	Lado	Pol. Ø	Pol. mm
	T	D	7/8"	22,22
Cód. Original				
A-5821/ V-RCCR-0048.1				

	Aplicação - GM		Ano	
	Opala/ Caravan		81/...	
	Eixo	Lado	Pol. Ø	Pol. mm
	T	D	7/8"	22,22
Cód. Original				
V-RCCR-0053.8				

	Aplicação - GM		Ano	
	Monza/ Ipanema		88/...	
	Eixo	Lado	Pol. Ø	Pol. mm
	T	E	7/8"	22,22
Cód. Original				
A-5820/ V-RCCR-0047.3				

	Aplicação - GM		Ano	
	Chevette/ Marajó		09-80/03-87	
	Chevy		83/03-87	
	Eixo	Lado	Pol. Ø	Pol. mm
T	E/D	3/4"	19,05	
Cód. Original				
B-225.8667				

	Aplicação - GM		Ano	
	Kadett		89/...	
	Eixo	Lado	Pol. Ø	Pol. mm
	T	E	13/16"	20,64
Cód. Original				
A-5448/ V-RCCR-0082.1				

	Aplicação - GM		Ano	
	Chevette		78/04-80	
	Eixo	Lado	Pol. Ø	Pol. mm
	T	E/D	11/16"	17,46
Cód. Original				
V-RCCR-2774.6				

	Aplicação - GM		Ano	
	Kadett		89/...	
	Eixo	Lado	Pol. Ø	Pol. mm
	T	D	13/16"	20,64
Cód. Original				
A-5449/ V-RCCR-0083.1				

	Aplicação - GM		Ano	
	Chevette		05-80/86	
	Chevy		83/86	
	Marajó		81/86	
Eixo	Lado	Pol. Ø	Pol. mm	
T	E/D	3/4"	19,05	
Cód. Original				
V-RCCR-0138.0				

	Aplicação - GM		Ano	
	Chevette/ Chevy/ Marajó		04-87/...	
	Eixo	Lado	Pol. Ø	Pol. mm
	T	E/D	7/8"	22,22
Cód. Original				
B-225.9416/ V-RCCR-0211.0				

	Aplicação - GM		Ano	
	Chevette/ Chevy/ Marajó		87/...	
	Eixo	Lado	Pol. Ø	Pol. mm
	T	E/D	7/8"	22,22
Cód. Original				
V-RCCR-0015.5				

	Aplicação - GM		Ano	
	Monza/ Ipanema		89/...	
	Eixo	Lado	Pol. Ø	Pol. mm
	T	E	7/8"	22,22
Cód. Original				
B-226.0699/ V-RCCR-0204.0				

	Aplicação - GM		Ano	
	Monza		82/87	
	Eixo	Lado	Pol. Ø	Pol. mm
	T	E	3/4"	19,05
Cód. Original				
A-5302/ V-RCCR-0032.5				

	Aplicação - GM		Ano	
	Monza/ Ipanema		89/...	
	Eixo	Lado	Pol. Ø	Pol. mm
	T	D	7/8"	22,22
Cód. Original				
B-226.0700/ V-RCCR-0205.0				





Cilindros de Roda



	Aplicação - GM		Ano	
	Corsa		94/...	
	Astra (ABS)		95/...	
	Vectra		97/...	
Tigra		98/99		
Zafira		2001/...		
Meriva		2003/...		
Eixo	Lado	Pol. Ø	Pol. mm	
T	E/D	3/4"	19,05	
Cód. Original				
V-RCCR-0130.5/ B-CR-2754				

	Aplicação - GM		Ano	
	Corsa		02/...	
	Eixo	Lado	Pol. Ø	Pol. mm
	T	E/D	3/4"	19,05
Cód. Original				
GM-9049.8300 (alumínio)				

	Aplicação - GM		Ano	
	Pick-Up Corsa		95/...	
	Eixo	Lado	Pol. Ø	Pol. mm
	T	E	7/8"	22,22
Cód. Original				
V-RCCR-0136.0/ B-CR-9190				

	Aplicação - GM		Ano	
	Montana		04/...	
	Eixo	Lado	Pol. Ø	Pol. mm
	T	E/D	7/8"	22,22
Cód. Original				
93313891				

	Aplicação - GM		Ano	
	Pick-Up Corsa		95/...	
	Eixo	Lado	Pol. Ø	Pol. mm
	T	D	7/8"	22,22
Cód. Original				
V-RCCR-0137.0/ B-CR-9191				

ASIA Asia

	Aplicação - GM		Ano	
	Opala/ Caravan		09-80/04-83	
	Eixo	Lado	Pol. Ø	Pol. mm
	T	E	7/8"	22,22
Cód. Original				
B-225.8704				

	Aplicação - ASIA		Ano	
	Townner		Todos	
	Eixo	Lado	Pol. Ø	Pol. mm
	T	E	11/16"	17,46
Cód. Original				
AA-100.26.710				

	Aplicação - GM		Ano	
	Opala/ Caravan		09-80/04-83	
	Eixo	Lado	Pol. Ø	Pol. mm
	T	D	7/8"	22,22
Cód. Original				
B-225.8705				

	Aplicação - ASIA		Ano	
	Townner		Todos	
	Eixo	Lado	Pol. Ø	Pol. mm
	T	D	11/16"	17,46
Cód. Original				
AA-100.26.610				

	Aplicação - GM		Ano	
	Opala/ Caravan		09-80/04-83	
	Eixo	Lado	Pol. Ø	Pol. mm
	T	D	7/8"	22,22
Cód. Original				
B-225.8705				

	Aplicação - ASIA		Ano	
	Topic		Todos	
	Eixo	Lado	Pol. Ø	Pol. mm
	T	E	3/4"	19,05
Cód. Original				
KB-01.26.710-A				

	Aplicação - GM		Ano	
	Kadett		89/...	
	Eixo	Lado	Pol. Ø	Pol. mm
	T	E	13/16"	20,64
Cód. Original				
B-226.0701/ V-RCCR-0206.0				

	Aplicação - ASIA		Ano	
	Topic		Todos	
	Eixo	Lado	Pol. Ø	Pol. mm
	T	D	3/4"	19,05
Cód. Original				
KB-01.26.610-A				

Audi

	Aplicação - GM		Ano	
	Kadett		89/...	
	Eixo	Lado	Pol. Ø	Pol. mm
	T	D	13/16"	20,64
Cód. Original				
B-226.0702/ V-RCCR-0207.0				

	Aplicação - AUDI		Ano	
	A3		96/...	
	Eixo	Lado	Pol. Ø	Pol. mm
	T	E/D	11/16"	17,46
Cód. Original				
TRW/ FTE (alumínio)				





Cilindros de Roda



Citroën

	Aplicação - CITROËN		Ano	
	Jumper		96/...	
	Eixo	Lado	Pol. Ø	Pol. mm
	T	E/D	1.1/16"	27,00
Cód. Original				

	Aplicação - CITROËN		Ano	
	Xsara s/ ABS		98/...	
	ZX s/ ABS		92/98	
	Eixo	Lado	Pol. Ø	Pol. mm
T	D	13/16"	20,64	
Cód. Original				
V-RCCR-0296.0 B-CR-2728 Sist. Bendix com Válvula				

	Aplicação - CITROËN		Ano	
	Xsara s/ ABS		98/...	
	ZX s/ ABS		92/98	
	Eixo	Lado	Pol. Ø	Pol. mm
T	E	13/16"	20,64	
Cód. Original				
V-RCCR-0295.0 B-CR-2727 Sist. Bendix com Válvula				

Honda

	Aplicação - HONDA		Ano	
	Civic EX/ CRX		92/2000	
	Accord		90/93	
	Eixo	Lado	Pol. Ø	Pol. mm
T	E	3/4"	19,05	
Cód. Original				
V-RCCR-0181.0 (alumínio)				

	Aplicação - HONDA		Ano	
	Civic EX/ CRX		92/2000	
	Accord		90/93	
	Eixo	Lado	Pol. Ø	Pol. mm
T	D	3/4"	19,05	
Cód. Original				
V-RCCR-0182.0 (alumínio)				

	Aplicação - HONDA		Ano	
	Civic		2001/...	
	Eixo	Lado	Pol. Ø	Pol. mm
	T	E	3/4"	19,05
Cód. Original				
(alumínio)				

	Aplicação - HONDA		Ano	
	Civic		2001/...	
	Eixo	Lado	Pol. Ø	Pol. mm
	T	D	3/4"	19,05
Cód. Original				
(alumínio)				

	Aplicação - HONDA		Ano	
	Fit		2003/...	
	Eixo	Lado	Pol. Ø	Pol. mm
	T	E/D	11/16"	17,46
Cód. Original				
43300-SAA-G01				

Hyundai

	Aplicação - HYUNDAI		Ano	
	Atos		00/...	
	Eixo	Lado	Pol. Ø	Pol. mm
	T	E/D	11/16"	17,78
Cód. Original				
V-RCCR-0191-0				

	Aplicação - HYUNDAI		Ano	
	H-100		95/99	
	Eixo	Lado	Pol. Ø	Pol. mm
	T	E	3/4"	19,05
Cód. Original				
58.320.44010				

	Aplicação - HYUNDAI		Ano	
	H-100		95/99	
	Eixo	Lado	Pol. Ø	Pol. mm
	T	D	3/4"	19,05
Cód. Original				
58.320.44011				

	Aplicação - HYUNDAI		Ano	
	Tucson		05/...	
	Eixo	Lado	Pol. Ø	Pol. mm
	T	E/D	13/16"	20,64
Cód. Original				
58330-2E500 (alumínio)				

KIA

	Aplicação - KIA		Ano	
	Besta GS		98/...	
	Eixo	Lado	Pol. Ø	Pol. mm
	T	E	3/4"	19,05
Cód. Original				
KB-01.26.710-A				

	Aplicação - KIA		Ano	
	Besta GS		98/...	
	Eixo	Lado	Pol. Ø	Pol. mm
	T	D	3/4"	19,05
Cód. Original				
KB-01.26.610-A				







Cilindros de Roda





	Aplicação - KIA		Ano	
	Besta		93/97	
	Eixo	Lado	Pol. Ø	Pol. mm
	T	E	11/16"	17,46
CCR-92105				
Cód. Original				
OKB-01.26.710-A				

	Aplicação - KIA		Ano	
	Besta		93/97	
	Eixo	Lado	Pol. Ø	Pol. mm
	T	D	11/16"	17,46
CCR-92106				
Cód. Original				
OKB-01.26.610-A				

Mercedes-Bens

	Aplicação - MB		Ano	
	Classe A		99/...	
	Eixo	Lado	Pol. Ø	Pol. mm
	T	E/D	11/16"	17,78
CCR-92127				
Cód. Original				
(alumínio)				

	Aplicação - MB		Ano	
	MB-310 Sprinter		Todos	
	Eixo	Lado	Pol. Ø	Pol. mm
	T	E	13/16"	20,64
CCR-92131				
Cód. Original				
V-RCCR-0098-0				

	Aplicação - MB		Ano	
	MB-310 Sprinter		Todos	
	Eixo	Lado	Pol. Ø	Pol. mm
	T	D	13/16"	20,64
CCR-92132				
Cód. Original				
V-RCCR-0099-0				

	Aplicação - MB		Ano	
	L-608D		72/86	
	LO-608		76/86	
	Eixo	Lado	Pol. Ø	Pol. mm
T/D	E/D	7/8"	22,22	
CCR-92133				
Cód. Original				
V-RCCR-0002.3/ B-CR-9204				

Peugeot

	Aplicação - PEUGEOT		Ano	
	206		99/...	
	306 s/ ABS		94/04	
	Eixo	Lado	Pol. Ø	Pol. mm
T	D	13/16"	20,64	
CCR-92236				
Cód. Original				
V-RCCR-0296.0				
B-CR-2728 Sist. Bendix com Válvula				

	Aplicação - PEUGEOT		Ano	
	206		99/...	
	306 s/ ABS		94/04	
	Eixo	Lado	Pol. Ø	Pol. mm
T	E	13/16"	20,64	
CCR-92237				
Cód. Original				
V-RCCR-0295.0				
B-CR-2727 Sist. Bendix com Válvula				

Renault

	Aplicação - RENAULT		Ano	
	R19		92/99	
	Clio		96/99	
	Eixo	Lado	Pol. Ø	Pol. mm
T	E	---	22,00	
CCR-92113				
Cód. Original				
RCCR-0239.0				

	Aplicação - RENAULT		Ano	
	R19		92/99	
	Clio		96/99	
	Eixo	Lado	Pol. Ø	Pol. mm
T	D	---	22,00	
CCR-92114				
Cód. Original				
RCCR-0240.0				

	Aplicação - RENAULT		Ano	
	Clio		00/...	
	Eixo	Lado	Pol. Ø	Pol. mm
	T	E/D	11/16"	17,78
CCR-92118				
Cód. Original				
RCCR-0291-0 TRW				

	Aplicação - RENAULT		Ano	
	R-19 RN		92/98	
	Eixo	Lado	Pol. Ø	Pol. mm
	T	D	13/16"	20,64
CCR-92236				
Cód. Original				
V-RCCR-0296.0				
B-CR-2728 Sist. Bendix com Válvula				

	Aplicação - RENAULT		Ano	
	R-19 RN		92/98	
	Eixo	Lado	Pol. Ø	Pol. mm
	T	E	13/16"	20,64
CCR-92237				
Cód. Original				
V-RCCR-0295.0				
B-CR-2727 Sist. Bendix com Válvula				

	Aplicação - RENAULT		Ano	
	Logan		08/...	
	Eixo	Lado	Pol. Ø	Pol. mm
	T	E/D	11/16"	17,46
CCR-92250				
Cód. Original				
6001.551.410				
(alumínio)				







Cilindros de Roda





	Aplicação - SEAT		Ano	
	Cordoba/ Ibiza		95/99	
	Eixo	Lado	Pol. Ø	Pol. mm
	T	E/D	11/16"	17,46
Cód. Original				
V-RCCR-0139.0/ B-CR-2003				

	Aplicação - SEAT		Ano	
	Cordoba Vario/ Ibiza		95/02	
	Eixo	Lado	Pol. Ø	Pol. mm
	T	E/D	3/4"	19,05
Cód. Original				
V-RCCR-0001.5				



	Aplicação - TOYOTA		Ano	
	Corolla DX/ LX/ Paseo		92/98	
	Eixo	Lado	Pol. Ø	Pol. mm
	T	E	11/16"	17,46
Cód. Original				
V-RCCR-0161.0				

	Aplicação - TOYOTA		Ano	
	Corolla DX/ LX/ Paseo		92/98	
	Eixo	Lado	Pol. Ø	Pol. mm
	T	D	11/16"	17,46
Cód. Original				
V-RCCR-0162.0				

	Aplicação - TOYOTA		Ano	
	Hilux SW4		96/...	
	Eixo	Lado	Pol. Ø	Pol. mm
	T	E/D	15/16"	23,81
Cód. Original				
V-RCCR-0200.0				

	Aplicação - TOYOTA		Ano	
	Corolla		98/...	
	Eixo	Lado	Pol. Ø	Pol. mm
	T	E	3/4"	19,05
Cód. Original				
47570-20060				

	Aplicação - TOYOTA		Ano	
	Corolla		98/...	
	Eixo	Lado	Pol. Ø	Pol. mm
	T	D	3/4"	19,05
Cód. Original				
47550-20060				



KPA 162 8151



Aplicação

Ano

Citroën:

Xsara (sem ABS) 98/...
ZX (sem ABS) 92/98

Peugeot:

206 (sem ABS) 99/...
207 (sem ABS) 09/...
306 (sem ABS) 94/04

Renault:

R-19 RN 92/98

Eixo	Lado	Ø Pol	Ø MM
T	D	13/76"	20,64

Código Original

Código Original
8-CR-2727 Sistema Bendix com Válvula
V-RCCR-0295.0



KPA 162 8152



Aplicação

Ano

Citroën:

Xsara (sem ABS) 98/...
ZX (sem ABS) 92/98

Peugeot:

206 (sem ABS) 99/...
207 (sem ABS) 09/...
306 (sem ABS) 94/04

Renault:

R-19 RN 92/98

Eixo	Lado	Ø Pol	Ø MM
T	E	13/76"	20,64

Código Original

Código Original
8-CR-2727 Sistema Bendix com Válvula
V-RCCR-0295.0



Código	Descrição		Cod. Original
KPA 212 814	Kombi 67/82	Dianteiro	Superior esquerdo 2296-5
KPA 212 815	Kombi 67/82		Superior direito 2297-3
KPA 212 816	Kombi 67/82		Inferior esquerdo 2298-1
KPA 212 817	Kombi 67/82		Inferior direito 2299-1
KPA 212 809	Kombi 75/80	Traseiro	Esquerdo/Direito 2785-1
KPA 212 811	Kombi 66/74		Esquerdo/Direito 2295-7





Caixas de Direção

Totalmente Revisadas - 1ª Linha - Garantia de 6 Meses

(Todas as peças são substituídas por novas, somente a carcaça Original da Montadora é aproveitada)



10240007
Fusca, Brasilia, Variant



10320035
Kombi 69/83 (Chavetada)



10320036
Kombi Clipper 84/97 (Estriada)



10320039
Kombi Carat 97/07



7X041905
Kombi Flex 07/...

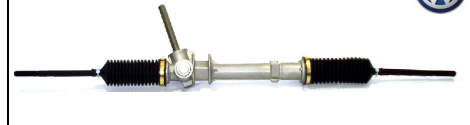

15902926
Fox 02/...



15900132
Gol (até geração IV), Voyage, Parati, Saveiro



54741906
Escort/ Sapão, Logus, Pointer 93/...



15900134
Uno, Elba, Premio, Fiorino, 147, Oggi, Spazio .../92 -Med. 12,0 x 1,5-Rosca Fina



15900135
147 .../84



15900136
Uno, Elba, Premio, Fiorino 92/94 Rosca Grossa - Med. 14,0 x 1,5



15900137
Uno, Elba, Premio, Fiorino 95/... Med. 14,0 x 1,5 - Com Pino



15900126
Palio, Siena 96/... - Med. 12,0 x 1,5



15900161
Palio, Siena Fire 01/...



37502387
Stilo 03/...



10300003
Corcel, Del Rey, Belina, Pampa 80/97



15900057
Escort, Verona, Apollo .../92



15900172
Fiesta 96/...





Caixas de Direção

Totalmente Revisadas - 1ª Linha - Garantia de 6 Meses

(Todas as peças são substituídas por novas, somente a carcaça Original da Montadora é aproveitada)

 15902929 Fiesta Novo 02/... e Fiesta Supercharger	 15900173 Ka 97/...	 15900131 Chevette
 2010110 Corsa, Celta .../03 - Rosca Fina (DHB)	 15900207 Corsa, Celta .../03 - Rosca Grossa (ZF)	 15900206 Corsa, Celta (DHB) 03/...
 15900022 Monza, Kadett	 682000007 Renault Clio	 15902922 Renault Logan, Sandero
 96272420 Peugeot 206		





Kit Estabilizador



Volkswagen



102 0202
Sedan 1200/1300 .../07-81



102 0203
Sedan 1500/1600/1300L/
Brasília, Variant 08-81/...



102 0204
Kombi - Esquerdo



102 0205
Kombi - Direito



102 0206
Passat 74/... - Externo



102 0207
Passat 74/... - Interno



102 0208
Gol, Voyage, Parati, Saveiro
82/... - Externo



102 0209
Gol, Voyage, Parati, Saveiro
82/... - Interno



102 0210
Passat 74 - Interno/ Externo



102 0211
Santana 84/... Gol 1.8 - Interno



102 0212
Santana 84/... Gol 1.8 - Externo



102 0213
Santana 84/... Gol 1.8 - Int/ Ext



102 0219
Escort, Logus, Pointer 93/...



102 0221
Gol, Voyage, Parati, Saveiro -
Interno/ Externo (1 Lado)



102 0230
Fox Todos, Polo exceto Classic,
Seat - Direito



102 0231
Fox Todos, Polo exceto Classic,
Seat - Esquerdo



402 0351
Uno, Premio, Elba 83/91



402 0353
Uno 91/... (Exc. R/Mille),
Furgão - AZUL





Kit Estabilizador



402 0354
Pick-Up, Fiorino .../93



402 0355
Uno R, Premio, Elba 91/...
Central - VERMELHA

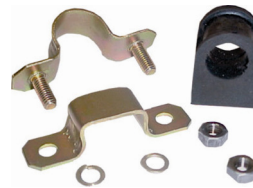

402 0356
Uno R, Premio, Elba 91/...
Ponta



402 0360
Palio EL- Esquerdo (Furo19mm)



402 0361
Palio EL - Direito (Furo19mm)



402 0362
Palio 16V- Esquerdo (Furo
20mm)



402 0363
Palio 16V - Direito (Furo20mm)



202 0255
Monza 84/90 Todos exceto SR



202 0256
Monza 91/...



202 0260
Corsa 1.0/ 1.4 94/...



202 0261
Corsa, Pick-Up 95/...



202 0263
Vectra 96/...



202 0273
Meriva, Novo Corsa, Astra
99/...



202 0274
Zafira



302 0304
Escort 84/86 - 90/92



302 0305
Escort 87/92



302 0306
Escort Hobby Todos



302 0307
Fiesta Todos, Courier, Escort
Zetec 97/...





Kit Estabilizador



302 0308
Ka Todos



302 0311
Ecosport, Fiesta 03/...



Peugeot



602 0375
Peugeot 206 - Todos



602 0376
306, Partner, Xsara, Berlingo
(19mm)



602 0377
306, Partner, Xsara, Berlingo
(21mm)



602 0378
306, Partner, Xsara, Berlingo
(23mm)



Renault



502 0390
Clio, R-19 93, Megane 97/...
Externa



502 0391
Clio, R-19 93, Megane 97/...
Interna



Toyota



902 0392
Toyota Corolla 92/97 - Esquerdo



902 0393
Toyota Corolla 92/97 - Direito



902 0394
Toyota Corolla 92/97 - Traseiro





Volkswagen



	<p>101 0001 Reparo Semi-Eixo completo Sedan, Brasília, Kombi</p>	<p>101 0002 Lado Roda com Graxa Passat, Gol, Voyage, Parati, Saveiro, Santana</p>	<p>101 0003 Reparo Semi-Eixo Lado Câmbio com Graxa Passat, Gol, Voyage, Parati, Santana, Quantum</p>
<p>101 0007 Reparo Semi-Eixo Lado Roda com Graxa Santana, Quantum 90/95</p>	<p>101 0010 Reparo Semi-Eixo Lado Roda com Graxa Santana 96/... Gol 2.0 16V 95/...</p>	<p>101 0006 Reparo Semi-Eixo Lado Roda com Graxa Logus, Escort, Verona 93/...</p>	<p>101 0008 Reparo Semi-Eixo Lado Câmbio com Graxa Logus, Santana, Gol 2.0 16V Escort 95/...</p>
<p>101 0005 Reparo Semi-Eixo Lado Câmbio/Roda com Graxa Kombi Clipper 78/97</p>	<p>101 0018 Reparo Semi-Eixo Lado Roda/ Câmbio com Graxa Kombi 98/...</p>	<p>301 0022 Reparo Semi-Eixo Lado Câmbio/Roda c/ Graxa Apollo, Escort, Verona .../92</p>	<p>101 0056 Reparo Semi-Eixo Lado Câmbio com Flange e Graxa Kombi 1.6 (exportação)</p>
<p>101 0019 Reparo do Semi-Eixo Lado Roda com Graxa Fox 03/... Polo 02/06</p>	<p>101 0020 Reparo do Semi-Eixo Lado Câmbio com Flange e Graxa Fox 03/...</p>	<p>101 0009 Reparo Semi-Eixo Lado Roda com Graxa Golf .../96</p>	<p>101 0054 Reparo Semi-Eixo Direito Lado Câmbio com Flange e Graxa Golf 94/98</p>
<p>101 0055 Reparo Semi-Eixo Esquerdo Lado Câmbio com Flange e Graxa Golf 94/98</p>	<p>101 0150 Reparo Semi-Eixo Direito Lado Câmbio com Graxa Golf 94/98, Polo Classic 96/00</p>	<p>101 0151 Reparo Semi-Eixo Esquerdo Lado Câmbio com Graxa Golf 94/98, Polo Classic 96/00</p>	<p>101 0158 Reparo Semi-Eixo Lado Roda com Graxa Gol GV 1.0 09/...</p>



Reparos Semi-Eixos

 <p>101 0159 Reparo Semi-Eixo Lado Roda com Graxa Gol GV 1.6 09/...</p>	 <p>101 0004 Reparo Semi-Eixo Lado Roda com Graxa Gol, Parati 95/...</p>	 	 <p>401 0033 Reparo Semi-Eixo Lado Câmbio Uno, Elba, Premio .../93</p>
 <p>401 0036 Reparo Semi-Eixo Lado Câmbio sem Rolamento Uno, Elba, Premio 91/95</p>	 <p>401 0037 Reparo Semi-Eixo Lado Câmbio com Rolamento Uno, Elba, Premio 91/95</p>	 <p>401 0044 Reparo Semi-Eixo Lado Câmbio com Rolamento Importado Uno, Elba, Premio 91/95</p>	 <p>401 0031 Reparo Semi-Eixo Lado Roda com Graxa Uno, Premio, Elba .../95</p>
 <p>401 0032 Reparo Semi-Eixo Lado Câmbio Fiat 147</p>	 <p>401 0034 Reparo Semi-Eixo Lado Roda com Graxa Tempra, Tipo 2.0</p>	 <p>401 0035 Reparo Semi-Eixo Lado Câmbio com Graxa Tempra, Tipo 2.0</p>	 <p>401 0046 Reparo Semi-Eixo Lado Roda com Graxa Marea 99/... Brava 00/...</p>
 <p>401 0038 Reparo Semi-Eixo Lado Roda com Graxa Palio 1.0</p>	 <p>401 0041 Reparo Semi-Eixo Lado Roda com Graxa Palio 1.5 16V 96/...</p>	 <p>401 0042 Reparo Semi-Eixo Lado Câmbio com Rolamento Palio 1.5 16V</p>	 <p>401 0040 Reparo Semi-Eixo Lado Câmbio com Rolamento Palio 1.0/Tipo 1.6, Uno 96/...</p>
 <p>401 0045 Reparo Semi-Eixo Lado Câmbio com Rolamento Importado Palio 1.0, Tipo 1.6, Uno 96/...</p>	 <p>401 0039 Reparo Semi-Eixo Lado Câmbio sem Rolamento Palio 1.0, 1.5 16V, Tipo 1.6, Uno 96/...</p>	 	 <p>201 0011 Reparo Semi-Eixo Lado Roda com Graxa Monza .../92, Astra 95/96 Kadett 89/98</p>



Reparos Semi-Eixos



 <p>201 0012 Reparo Semi-Eixo Lado Câmbio com Graxa Monza, Kadett, Ipanema, Astra 99/...</p>	 <p>201 0016 Reparo Semi-Eixo Lado Roda com Graxa Vectra 97/05, Monza 93/...</p>	 <p>201 0015 Reparo Semi-Eixo Lado Roda com Graxa Omega, Suprema, Vectra .../96</p>	 <p>201 0062 Reparo Semi-Eixo Lado Câmbio com Flange e Graxa Omega, Suprema, Vectra .../96</p>
 <p>201 0017 Reparo Semi-Eixo Lado Câmbio com Graxa Vectra 97/05</p>	 <p>201 0118 Reparo Semi-Eixo Lado Roda com Graxa Vectra 06/...</p>	 <p>201 0119 Reparo Semi-Eixo Lado Câmbio com Graxa Vectra 06/...</p>	 <p>201 0014 Reparo Semi-Eixo Lado Câmbio com Graxa Corsa 94/01, Celta 01/...</p>
 <p>201 0013 Reparo Semi-Eixo Lado Roda com Graxa Corsa 94/01, Celta 01/...</p>	 <p>201 0068 Reparo Semi-Eixo Lado Câmbio com Graxa Corsa Novo 02/...</p>	 <p>201 0067 Reparo Semi-Eixo Lado Roda com Graxa Corsa Novo 02/...</p>	 <p>201 0117 Reparo Semi-Eixo Lado Câmbio com Graxa Meriva 02/...</p>
 <p>201 0069 Reparo Semi-Eixo Lado Roda com Graxa Meriva 02/...</p>	 <p>201 0066 Reparo Semi-Eixo Lado Roda com Graxa Astra 99/... Zafira 01/...</p>		 <p>101 0006 Reparo Semi-Eixo Lado Roda com Graxa Escort, Verona, Logus 93/...</p>
 <p>101 0008 Reparo Semi-Eixo Lado Câmbio com Graxa Escort , Logus, Santana, Gol 2.0 16V 95/...</p>	 <p>301 0022 Reparo Semi-Eixo Lado Câmbio/Roda c/ Graxa Escort, Verona, Apollo .../92</p>	 <p>301 0024 Reparo Semi-Eixo Lado Roda com Graxa Fiesta 1.0/1.4 96/...</p>	 <p>301 0025 Reparo Semi-Eixo Lado Câmbio com Graxa Fiesta 1.0 1.4 .../96</p>



Reparos Semi-Eixos

 <p>301 0130 Reparo Semi-Eixo Lado Câmbio com Graxa Fiesta 03/...</p>	 <p>301 0131 Reparo Semi-Eixo Lado Roda com Graxa Fiesta 03/...</p>	 <p>301 0026 Reparo Semi-Eixo Lado Roda com Graxa Ka 97/... Fiesta 1.6 96/02</p>	 <p>301 0027 Reparo Semi-Eixo Lado Câmbio com Graxa Ka 97/... Fiesta 1.6 96/02</p>
 <p>301 0021 Reparo Semi-Eixo Lado Roda com Graxa Corcel, Del Rey, Belina, Pampa</p>	 <p>301 0023 Reparo Semi-Eixo Lado Câmbio com Graxa Corcel, Del Rey, Belina, Pampa</p>	 <p>KPA-9129 Reparo Semi-Eixo Lado Câmbio Completo Focus 01/...</p>	 <p>KPA-9128 Reparo Semi-Eixo Lado Roda Completo Focus 01/...</p>
 <p>Honda ➔</p>	 <p>801 0094 Reparo do Semi-Eixo Lado Roda com Graxa Fit 04/...</p>	 <p>801 0095 Reparo Semi-Eixo Lado Roda com Graxa Civic 95/00</p>	 <p>801 0093 Reparo do Semi-Eixo Lado Câmbio com Graxa Civic 01/... (Exceto New Civic)</p>
 <p>901 0087 Reparo do Semi-Eixo Lado Roda com Graxa Civic 01/... Corolla 03/...</p>	 <p>Peugeot ➔</p>	 <p>KPA-9189 Reparo Semi-Eixo Lado Roda com Graxa 206, 306 (Eixo 34mm)</p>	 <p>KPA-9192 Reparo Semi-Eixo Lado Câmbio Completo 106, 205, 206, 306, 405, 605, 806, Boxer, Partner</p>
 <p>KPA-9193 Reparo Semi-Eixo Lado Roda com Graxa 106, 205, 206, 405, 608, 806</p>	 <p>Renault ➔</p>	 <p>501 0096 Reparo Semi-Eixo Lado Roda com Graxa Clio .../96</p>	 <p>501 0190 Reparo Semi-Eixo Direito Lado Câmbio com Graxa Clio 01/... Kangoo 03/...</p>



Reparos Semi-Eixos



 <p>501 0189 Reparo Semi-Eixo Lado Roda com Graxa Clio 01/... Kangoo 03/...</p>	 <p>KPA-9153 Reparo Semi-Eixo Esquerdo Lado Câmbio com Rolamento Importado Clio todos, Laguna 8V Kangoo, Twingo, R19, R21</p>	 <p>501 0073 Reparo Semi-Eixo Esquerdo Lado Câmbio Clio todos, Laguna 8V Kangoo, Twingo, R19, R21</p>	 <p>501 0072 Reparo Semi-Eixo Lado Roda com Graxa Renault 19, Clio, Express, Kangoo</p>
 <p>KPA-9152 Reparo Semi-Eixo Lado Esq. Câmbio c/ Rolamento Scenic todos, Megane, Laguna 2.0 16V</p>	 <p>501 0197 Reparo Semi-Eixo Lado Dir. Câmbio com Graxa Sander, Logan</p>	 <p>KPA-9194 Reparo Semi-Eixo Lado Esquerdo Câmbio Sander, Logan</p>	 <p>KPA-9196 Reparo Semi-Eixo Lado Roda com Graxa Sander, Logan</p>
 <p>Toyota</p>	 <p>901 0086 Reparo do Semi-Eixo Lado Câmbio com Graxa Corolla 03/...</p>	 <p>901 0087 Reparo do Semi-Eixo Lado Roda com Graxa Corolla 03/... Civic 01/...</p>	

Reparos Semi-Eixos Universais

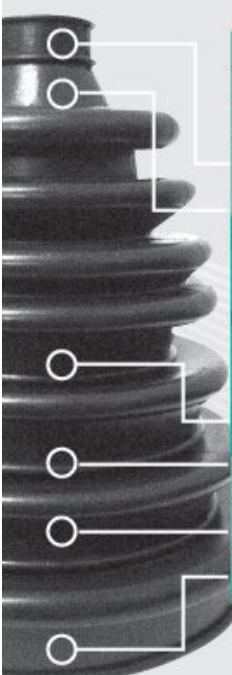
Tamanho da coifa (em mm)			
9960		9961	
Ø menor	Ø maior	Ø menor	Ø maior
17	21	20	24
21	27	24	34

EFETUE O CORTE SEGUNDO SUAS NECESSIDADES

45	55	81	92
55	65	92	106
65	75	106	116
75	90	125	125

KPA-9960
▪ Veículos Leves e Comerciais Pequenos



- Evite esperar por reposição.
- Evite desmontar a homocinética.



Cobre mais de **90%** das aplicações do mercado*

KPA-9961
▪ Veículos Comerciais Médios e 4x4



*Com os dois modelos de coifas universais GRIFFO





Rolamentos

Linha Capa e Cone



Código	Descrição - Marca
11749/710	Rolamento Roda Traseira - Externo GM: Monza, Kadett e Ipanema Hyundai: Atos VW: Apollo, Fusca, Gol, Gol BX, Golf 94/98, Passat, Parati, Quantum, Santana, Saveiro, Voyage e Van Mercedes-Benz: 190E e 230E Marca: VTO e DSI
11949/910	Rolamento Roda Dianteira/Traseira - Externo Audi (Traseiro): A4 e A4 Avant 1.8, 2.4 e 2.8, A6 e A6 Avant 95/97, Audi 80 e 100 Ford (Traseiro): Corcel II, Belina II, Del Rey, Scalla e Pampa 78/90 Ford (Dianteiro): F10083/... F1000 79/... Ranger e Explorer 4X2 /95 GM (Dianteiro): Opala e Caravan 2.5 e 4.1 75/... Chevet GM (Câmbio): S10 e Blazer - eixo secundário dianteiro GAS/DIESEL 4cil 2.2 e 2.5 Lada (Dianteiro): Laika VW (Dianteiro): Kombi 1500 .../78 e Kombi 1600 78/... VW (Traseiro): Van 1.6 11/98>07/99 Códigos: SKF: LM 11949/910/Q. TIMKEN: LM 11910/949. FORD: B5A 1216 A GM: 93209060. LADA: 2101-3103025. VW: 211405645.1 Marca: VTO
44649/610	Rolamento Roda Dianteira/Traseira - Interno Ford (Traseiro): Corcel II, Belina II, Del Rey, Scalla e Pampa 78/90 GM (Dianteiro): Opala e Caravan 2.5 e 4.1 75/... Chevette, Junior, Chevy 500 e Marajó. Hyundai: Atos Ford: 59721 GM: 9415132 Marca: VTO
45449/410	Rolamento Roda Traseira - Interno Audi: A3, S3 e TT 1.6, 1.8, 1.8T - nacional e importado - câmbio manual GM: Monza, Kadett, Ipanema VW: Gol, Gol BX, Passat, Golf 94/98, Santana, Parati, Saveiro, Voyage, Quantum, Van, Apollo e Fusca Marca: VTO
78349/310	Rolamento Roda Dianteira Ford: Corcel II, Belina, Pampa Del Rey - Todos Código Ford: 551407625 Marca: VTO
67048/010	Rolamento Roda Dianteira Interno Ford: Explorer 95/... Ranger 94/97 GM: Blazer, S10, Camaro, Opala/Caravan 75/... Mercedes-Benz: 190E e 230E VW: Kombi Marca: VTO
68145	Rolamento Roda Dianteira Ford: Escort e Verona .../93 Marca: VTO



Linha 3000



30304	Roda Dianteira – Corcel I - Marca: VTO
30305	Roda Dianteira – Corcel e Volkswagen - Marca: VTO



Linha 6000



6000-2RS	Industriais diversos, embreagem CB 400, alternador Delco, CS 144, Ford, USA - Marca: VTO
6003-2RS	Alternador Bosch, Magnet Marelli Fiat Palio, Yamaha XT 600 - Marca: VTO
6201-ZZ	Alternador L polia MB, Bosch, VW28043160, Alavanca embreagem Scania - Marca: KYB
6201-2RSVTO	Alternador L polia MB, Bosch, VW28043160, Alavanca embreagem Scania - Marca: VTO
6201-2RS	Alternador L polia MB, Bosch, VW28043160, Alavanca embreagem Scania - Marca: DSI
6202-2RSVTO	Alternador/gerador, L coletor Bosch, Dimano VW, Ford motor de partida Bosch JE-MB, VW - Marca: VTO
6202-2RS	Alternador/gerador, L coletor Bosch, Dimano VW, Ford motor de partida Bosch JE-MB, VW - Marca: DSI
6203-2RSVTO	Dínamo Bosch e Wapsa, VW 1.2/1.3/1.5/1.6, Alternador Wapsa, Bosch, VW, Ford - Marca: VTO
6203-2RS	Dínamo Bosch e Wapsa, VW 1.2/1.3/1.5/1.6, Alternador Wapsa, Bosch, VW, Ford - Marca: DSI
6204-2RS	Alternador F1000, F4000, Cargo, Suporte Cardan, Agrale, Trator 4100 - Marca: VTO
6301-ZZ	Roda Dianteira Moto Honda CG, ML, XL 125, Industriais Diversos - Marca: DSI
6303-2RS	Alternador MB LP 321L e LO 608/708/709 - Marca: VTO
6304-2RS	Câmbio Passat piloto traseiro 84/... ventilador MB - Marca: DSI





Rolamentos

Kit de Roda Traseira e Dianteira



Código	Marca	Referência	Roda	Descrição
VK4TV	VTO	VKBA 4529	Traseira	VW: Gol, Parati, Saveiro, Voyage, Santana, Quantum, Passat (nacional), Golf (06/94 à 07/98), Polo Classic (.../08/00), Passat Importado 11/94 à 07/97 Seat: Cordoba, Ibiza GLX e SXE de 96 até 09/99 Ford: Versailles, Royale 1.8, 2.0 todos
Este Kit Contém: 1 rolamento 45449/10, 1 rolamento 11749/10, 1 retentor 988, 1 cupilha, 1 graxa 40g				
VK22DV	VTO		Dianteira	VW: Fusca, Brasília 1.3, 1.5 e 1.6 .../74
Este Kit Contém: 1 rolamento 30304, 1 rolamento 30305, 1 retentor 109, 1 cupilha, 1 graxa 40g				
VK23DV	VTO		Dianteira	VW: Fusca, Brasília 1.3, 1.5 e 1.6 74/...
Este Kit Contém: 1 rolamento 45449/10, 1 rolamento 11749/10, 1 retentor 979, 1 cupilha, 1 graxa 40g				
VK6DV	VTO	VKBA 4505	Dianteira	VW: Kombi 74/...
Este Kit Contém: 1 rolamento 67048/10, 1 rolamento 11949/10, 1 retentor 324, 1 cupilha, 1 graxa 40g				
VK7TV	VTO		Traseira	VW: Kombi 1600 78/...
Este Kit Contém: 1 rolamento V6207, 2 retentores 139, 1 rolamento 45226				
VK11TG	VTO		Traseira	GM: S10, Blazer
Este Kit Contém: 1 rolamento 399/360L, 1 retentor 395, 1 flange, 1 anel elástico, 1 graxa 40g.				
VK3TF	VTO	VKBA 4533	Traseira	VW: Logus, Pointer 93/97 Ford: Escort (sapão), Verona 94/... , Fiesta (exceto Novo Fiesta), Ka
Este Kit Contém: 2 rolamentos 329013, 1 retentor 972, 1 cupilha, 1 graxa 40g				
VK2TF	VTO	VKBA 4528	Traseira	Ford: Escort, Verona .../93, Apolo 1.8
Este Kit Contém: 1 rolamento 45449/10, 1 rolamento 11749/10, 1 retentor 972, 1 cupilha, 1 graxa 40g				
VK16TF	VTO		Traseira	Ford: Ranger
Este Kit Contém: 1 rolamento 45087, 1 retentor 871				
VK19TF	VTO		Traseira	Ford: F1000 79/92
Este Kit Contém: 1 rolamento 399/365L, 1 retentor 693				
VK21TF	VTO		Traseira	Ford: Corcel I e II, Pampa, Del Rey, Scala todos
Este Kit Contém: 1 rolamento 44649/10, 1 rolamento 11949/10, 1 retentor 832, 1 cupilha, 1 graxa 40g				
VK1DF	VTO	VKBA4687 WBK 0006	Dianteira	Ford: Escort 1.6 E 1.8, Verona 83/96, Hobby, Apolo 90/92
Este Kit Contém: 2 rolamentos 68145/11, 1 retentor 442, 1 retentor 392, 1 cupilha, 1 graxa 40g				
VK5TG	VTO	VKBA 4544	Traseira	GM: Kadett, Ipanema, Monza 1.8, 2.0, Celta, Corsa .../01, Tigrá
Este Kit Contém: 1 rolamento 45449/10, 1 rolamento 11749/10, 1 retentor 212, 1 cupilha, 1 graxa 40g				
VK1432	VTO		Dianteira	Ford: Escort, Verona 94/... Fiesta, Ka, Courier, Logus, Pointer
Este Kit Contém: 1 rolamento B0036, 1 anel elástico, 1 porca				



Rolamento Agulha



Código	Descrição - Marca
NB 101	Rolamento de Roleta Grande GM: Opala, Monza e D20 - GM: 7451931 - INA 45853 Ford: Corcel II, Maverick, F350, F600 - Ford: BC7A10A-303B Chrysler: Dodge 1800 Alternador: Wapsa e Arno Marca: VTO
NB 102	Rolamento de Roleta Pequeno GM: C10, Chevette, Marajó, Opala, Caravan - GM: 7332316 Fiat: 147, Oggi, Fiorino - N° INA: F-45713 Marca: VTO



Rolamentos



Rolamento Roda Traseira



12025S9 (VTO)	Renault: Clio 1.0, 1.6 - 8v, 16v sem ABS, Megane, R19 sem ABS Citroën: C3 sem ABS, Xsara Peugeot: 106, 205, 206, 306 Marca: VTO
6306-2RS	VW: Brasília, Fusca, Karmann Ghia, TC, TL, Variant I, Kombi. - Marca: VTO
F45226	VW: Kombi 78/... (com rolete) - Original: 211.501.283.1 - Marca: VTO
329013	Interno e Externo Ford: Escort 1.6/1.8/2.0 94/... Verona 1.6 e 1.8 94/... Fiesta .../02, Ka VW: Logus 1.6 e 1.8 e Pointer 1.8 e 2.0 Código Ford: 547405645, 89FB1238AD VW: 547405645B Marca: DSI
U298/261L	GM: Chevette, Opala tipo DANA - Marca: DSI
V3601	GM: Corsa 02/... Meriva 04/... - Marca: VTO (Similar:40650)
FC40096	Renault: Master - Marca: DSI
801023VTO	Ford: Ecosport, Fiesta novo, Focus (dupla esfera) Marca: VTO



Rolamento Duplo da Roda Dianteira



Código	Descrição - Marca
311315VTO	Ford: Versailles, Royale 1.8/2.0 94/... VW: Passat, Variant II, Gol, Parati, Saveiro, Voyage .../93, Santana, Quantum .../93 Marca: VTO
311396VTO	Daewoo: Espero 2.0 <06/96 Ford: Escort 1.0/1.6/1.8/2.0 94/..., Verona 1.6/1.8 94/..., Ka, Courier, Fiesta .../02 Novo Fiesta, Focus e Ecosport s/ ABS, Versailles, Royale 1.8/ 2.0 04-94/... GM: Astra .../96, Calibra, Kadett, Ipanema, Monza, Vectra .../96 GM (Traseira): Omega e Suprema 2.0/ 2.2 VW: Gol Bola 04-94/... Fox s/ ABS, Parati, Voyage, Saveiro, Santana e Quantum - Todos 04-94/... Logus e Pointer Códigos Ford: 96FB1215 AA, 97FB1215 AA GM: 90279332, 90486460, 94655750, 94655750, 90486461, 1603191 INA: 45.920-1 Código Similar: B0036 Marca: VTO
311443	VW: Golf Importado (01/02/94 à 31/07/98), Polo Classic .../98 Seat: Ibiza, Cordoba Código VW: 357498625 Marca: VTO
801136VTO	VW: Golf 96/... Bora, New Beetle todos, Jetta Audi: A3, S3, TT Kia: Sephia Marca: VTO
801663	Ford: EcoSport, Fiesta Novo, Focus, Fusion s/ABS Marca: VTO
801065M	Ford: EcoSport, Fiesta novo, Focus c/ABS Marca: VTO
401288	Toyota: Corolla 02/... Código: 40BW12CA88 Marca: VTO
B0031 (633967)	Fiat: 147, Spazio, Elba, Oggi, Premio, Fiorino 95/94, Uno, Palio, Siena 1.6 Código FIAT: 500005010, 46439334 Código Similar: INA: 45.951-1 Marca: VTO
B3245	Honda: Civic 1.6 16V 95/... Fit 1.6 s/ABS Marca: VTO
B3246	Honda: Civic 1.6 16V 96/... 1.7 01/... 2.0 97/... c/ABS, Fit 1.6 c/ABS Marca: VTO
B0055	Fiat: Brava c/ABS, Marea 1.8 16V c/ABS, Palio, Siena 1.6 2000 c/ABS, Tempra 8V/16V c/ABS, Strada 1.5 8V, 1.6 8V/16V c/ABS, Punto, Linea 1.8 8V c/ABS Marca: VTO



B3598	Fiat: Stilo, Idea s/ ABS Marca: VTO
B3598M	Fiat: Stilo, Idea c/ ABS Marca: VTO
633313	Fiat: 147, Fiorino, Spazio, Elba, Oggi, Premio, Uno 85/... Lada: Samara 1.3/1.5 Aplica também no cubo roda traseira Uno Marca: VTO
636114VTO	GM: Astra antigo (Belga) 94/96, Celta, Corsa .../02, Tigra 1.4/1.6, Prisma 06/... Código GM: 93293729, 90447280, 93328044, 93273303, 1603195 Marca: VTO
803775	GM: Novo Corsa 02/... Meriva 04/... Montana 1.0/1.8 Todos Código Similar: F553648 Marca: VTO
548083VTO	Fiat: Tipo 1.6 95/... Punto, Linea 1.4 8V Fire Peugeot: 205, 306 1.4 sem ABS Citroën: AX, ZN, Xsara 1.4, 1.6, 1.5D Código Fiat: 5890990/7555466 Marca: VTO
B0004	Alfa Romeo: 164 2.0/3.0 V6 Fiat: Marea 2.0/2.4 16V/20V Código Similar: VKBA 1488 Marca: VTO
B0012 (633531)	Alfa Romeo: 164 2.0 TS <CH0014991 – Blindado Fiat: Tempra 8V/16V s/ABS, Tipo 2.0, Brava s/ABS, Strada 1.5 8V/1.6 8V/16V s/ABS, Marea 1.8 16V, Brava e Doblò s/ ABS, Punto, Linea 1.8 8V Código Fiat: 5890987/464238690 Código Similar: 633531 Marca: VTO
B3729	Toyota: Corolla 1.6/1.8 02/... c/ABS D3872W8CS81 Marca: VTO
B3730	Toyota: Corolla 1.6/1.8 02/... s/ABS Marca: VTO
636096 (581108)	GM: Vectra 97/... Código GM: 1603196, 90425658, VKBA 3410 Marca: VEP
12033	Renault: Clio s/ABS, R19 1.6, Twingo Marca: VTO
40547	Citroën: Xsara Peugeot: 106 4 furos, 206 Marca: VTO
40574	Citroën: Xsara 1.8/2.0 16V Peugeot: 205, 306, 307, 405, 406, Boxer c/ ABS Marca: VTO
487844M	Honda: Civic 06/... c/ABS Marca: VTO



ROLT 1102

Ø Ext. 70,2 mm
Ø Int. 17 mm
Larg. 26 mm



NY 1129 / VTO7080

Polia Alternador Astra, Corsa, Celta, Vectra, Fox, Polo, Golf, Escort, Ducato

ROLT 1151

Ø Ext. 70 mm
Ø Int. 17 mm
Larg. 25 mm



NY 1133 / VTO8010

Polia Alternador Palio, Punto, Siena, Idea, Doblo, Strada 1.8 8v

ROLT 1155

Ø Ext. 66 mm
Ø Int. 17 mm
Larg. 23,5 mm



NY 1143 / VTO7061

Polia Alternador Uno Mille, Palio, Siena, Doblo, Strada Fire 8v / 16v

ROLT 1155CP

Ø Ext. 66 mm
Ø Int. 17 mm
Larg. 23,5 mm



NY ---- / VTO7060

Polia Alternador Uno Mille, Palio, Siena, Doblo, Strada Fire 8v / 16v - **com parafuso**

ROLT 1156

Ø Ext. 80 mm
Ø Int. 10,3 mm
Larg. 28 mm



NY 1144 / VTO7085

Polia Alternador Fiorino, Strada, Uno 1.5 97/ Palio, Siena 1.0/1.5

ROLT 1158

Ø Ext. 80 mm
Ø Int. 17 mm
Larg. 26 mm

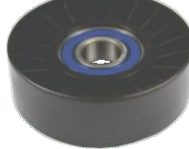

NY 1167 / VTO7058

Polia Alternador Palio, Siena, Strada Fiorino 1.0/1.5 99/ - exeto 6 marchas

ROLT 1160

Ø Ext. 77 mm
Ø Int. 17 mm
Larg. 23 mm

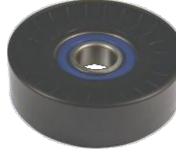

NY 1178 / VTO7017

Polia Alternador Corsa 02/ Meriva, Montana 1.8 8/16V, Classe A 160 / 190

ROLT 1178

Ø Ext. 59 mm
Ø Int. 30 mm
Larg. 24 mm



NY 7732 / VTO7070

Polia Correia Dent. Uno 93/ Palio 96/ Fiorino 89/ Elba, Premio, Siena, Tipo, Strada - **sem cubo**

ROLT 1178CP

Ø Ext. 59 mm
Ø Int. 30 mm
Larg. 24 mm



NY 7732CP / VTO7060

Polia Correia Dent. Uno 93/ Palio 96/ Fiorino 89/ Elba, Premio, Siena, Tipo, Strada - **com cubo**

ROLT 1221

Ø Ext. 70 mm
Ø Int. 17 mm
Larg. 26 mm



NY 1160 / VTO7080N

Polia Alternador Corsa, Celta, Astra, Fox, Polo, Golf, Ka, Fiesta, Corola etc

ROLT 1230

Ø Ext. 76,2 mm
Ø Int. 8,3 mm
Larg. 31 mm



NY 1179 / VTO8012

Polia Alternador Ecosport 2.0 16v Duratec, Mondeo 2.0 16v, Fusion 2.3 Duratec

ROLT 1234

Ø Ext. 69,5 mm
Ø Int. 17 mm
Larg. 24 mm



NY 1225 / VTO7015

Polia Alternador Ka, Fiesta, Courier, Focus, Ecosport, S10 e Blazer 4.3 V6 96/

ROLT 1374

Ø Ext. 56,2 mm
Ø Int. 10,3 mm
Larg. 21 mm



NY 1150 / VTO8087

Polia Correia Dent. Peugeot 206 1.0 16v Clio, Kangoo 1.0 16v - **com ar / direção**

ROLT 1501

Ø Ext. 80 mm
Ø Int. 17 mm
Larg. 26 mm



NY 1130 / VTO7019

Polia Alternador Honda Fit 1.4 Omega, Suprema 3.0

ROLT 1605

Ø Ext. 56 mm
Ø Int. 8,3 mm
Larg. 26,2 mm



NY 2092 / VTO7089

Polia Correia Dent. Gol, Parati AT 1.0 16v Cordoba, Ibiza 1.0 16v

ROLT 1121

Ø Ext. 72 mm
Larg. 26 mm



NY 7711 / VTO8182

Tensor Correia Dent. Golf GTI 98/09, Audi A3, S3, TT Turbo 97/06

ROLT 1150

Ø Ext. 60,3 mm
Larg. 26 mm



NY 7829 / VTO8231

Tensor Alternador Peugeot 206, 207, 307 Partiner, Picasso, Xsara 1.4/1.6 16v - **cl ar**

ROLT 1182

Ø Ext. 55,5 mm
Ø Int. 8,5 mm
Larg. 29 mm



NY 7741 / VTO7062

Tensor Correia Dent. Uno, Palio, Siena, Strada Fire 8v

ROLT 1183

Ø Ext. 60 mm
Ø Int. 8,2 mm
Larg. 29 mm



NY 7742 / VTO7063

Tensor Correia Dent. Palio, Siena, Doblo, Idea, Punto Fire 16v

ROLT 1187

Ø Ext. 59,5 mm
Ø Int. 10,5 mm
Ø Int. 6,1 mm
Larg. 26 mm



NY 7747 / VTO7071

Tensor Correia Dent. Tempra 2.0 8v 92/95

ROLT 1250

Ø Ext. 70 mm
Larg. 26 mm



NY 7775 / VTO8013

Tensor Alternador Fiesta, Ka, Courier 1.0/1.6 Zetec Rocam - **sem ar / direção**

ROLT 1254

Ø Ext. 76 mm
Ø Int. 10,2 mm
Larg. 31 mm



NY 7801 / VTO8000

Tensor Alternador Gol, Parati, Saveiro, Santana, Versailles Todos AP - **com Ar**

ROLT 1420

Ø Ext. 65 mm
Ø Int. 8,3 mm
Larg. 32 mm



NY 7759 / VTO8099

Tensor Correia Dent. Clio, Megane, Scenic, Logan, Sandero, Symbol, Kangoo 1.6 16v

ROLT 1421

Ø Ext. 51,5 mm
Ø Int. 10,5 mm
Larg. 31 mm



NY 7765 / VTO8092

Tensor Correia Dent. Megane, Scenic, R19 1.8/2.0 8v

ROLT 1520

Ø Ext. 72 mm
Ø Int. 9,2 mm
Larg. 22 mm



NY 7790 / VTO7082

Tensor Correia Dent. Monza, Kadett, Ipanema 89/95, Espero

ROLT 1522

Ø Ext. 59 mm
Ø Int. 8,4 mm
Larg. 22 mm



NY 7793 / VTO7074

Tensor Correia Dent. Corsa 1.0/1.6 16v Tigrá 1.6 16V

ROLT 1609

Ø Ext. 60 mm
Ø Int. 8,3 mm
Larg. 26,9 mm



NY 7743 / VTO7079

Tensor Correia Dent. Gol, Parati AT 1.0 16v Polo, Cordoba, Ibiza 1.0 16v

ROLT 1626

Ø Ext. 71,8 mm
Ø Int. 10,5 mm
Larg. 21,6 mm



NY 7782 / VTO9243PG

Tensor Correia Dent. Gol, Saveiro, Santana, Parati, Apollo, Pointer, Escort, Verona Tds AP

A **NCK** Distribuidora pensando sempre em facilitar a agilizar a localização de suas peças desenvolveu seu catálogo da Linha de Tensores e Polias com todas as suas marcas em uma só descrição, com isso será possível haver até 3 diferentes marcas (Defabri; Defabri *Premium* e VTO) em um só produto. Também cada Linha (Volkswagen, Ford, Fiat, GM etc.) está separada por tipo: Tensores e Polias, assim a procura ficará muito mais fácil e rápida para nossos clientes e colaboradores. Segue exemplo abaixo:



Tabela de Conversão

VTO	Defabri	Nytron	Cobra	Original
VTO6821	9909	7784	8182	GM: 08.966.821 - 09.275.148
VTO6821-S10				GM: 52.251.292 - 70.670.195 - 70.810.058 Ford: F87A6A228AA - BF5T19W629A - 3L556A228AA Mercedes-Benz: 000.230.0010
VTO7001	9923	1128	177 026PP	Agrale: 9.407.0.380.002.4 MWM/ Ford: BF9T19A216BA GM: 940703800024 MWM/ Nissan / Troller: 9.407.0.380.002.4 MWM
VTO7002	9930		LH177626	Agrale: 9.407.0.381.009.4 MWM/ Ford: BF9T19A216AA GM: MSB38103 - 92.056.290/ Nissan / Troller: 9.407.0.381.009.4 MWM
VTO7003		7722	1350	Toyota: 13505-15050
VTO7009	99138	1117	LH107025	BMW: 112.817.481.31
VTO7015	9949	1225	LH177425	Ford: XS6E19A216CB - XS6E19A216CC - XS6E19A216CC - 97BB6A228AG - 1S7Q6A228AC - F77Z6B209AA - F3TZ6B209C GM: 10.239.670, 12.456.152, 12.561.094, 12.580.296, 89.017.309
VTO7017	9948	1178	LH177622	Fiat: 73.500.717/ GM: 90.571.758/ Mercedes-Benz: 166.202.0519
VTO7019	9986	1130	FE178026	GM: 90.324.036/ Honda: N3.1141.PWA.004
VTO7022	9987	1171	FE176526	GM: 933.361.84
VTO7025	99139	1118	LH108025	BMW: 112.817.481.30
VTO7029	9910	7736	6002LH	Audi / VW: 030.109.243.L
VTO7030	9942	1161	LH177024	VW/ Audi / Seat: 06A.903.315.E - 06A903.315.D/ GM: 90.530.764
VTO7031	9905	1114	FE177024	VW/ Audi: 032.145.299A, 03.145.276
VTO7034	99112	7772	2919	Citroën: 97.535.002 / Peugeot: 0829.19
VTO7038	99112	7762	2929	Citroën/ Peugeot: 975.350.02/ 082.919 / 082.929
VTO7039		7770	6015LH	Citroën/ Peugeot: 082.982 / 082.9C7
VTO7041	99122	1250	LH106027	Citroën/ Peugeot: 5751.98
VTO7043	99125	1280	LH106031	Citroën / Peugeot: 0830.42
VTO7044	99123	1251	LH085732	Citroën/ Peugeot: 083.020
VTO7045	9977	1146	LH179025	Citroën / Peugeot: 5751.20
VTO7046		1233	1096	Fiat: 464.410.96/ 777.856.4
VTO7047		7724		Fiat: 71734799
VTO7049	9951	7744	1718	Fiat: 754.171.8
VTO7051		7785	4820	Fiat: 46.524.820
VTO7052		7813	5519	Fiat: 55.193.730
VTO7054		7858	5717	Fiat: 73.500.717/ GM: 90.571.758
VTO7055	9944	1225	LH177425 CP	Ford: XS6E19A216CC/ XS6E19A216 CB
VTO7058	9950	1167	178026LH	Fiat: 46.524.820



Rolamentos de Tensão - Tensores e Polias



VTO	Defabri	Nytron	Cobra	Original
VTO7059		7726	7716	Citroën/ Peugeot: 082.990
VTO7060			LH176523 CP	Fiat: 467.569.37
VTO7061	9940	1143	LH176523	Fiat: 46.756.937
VTO7062	9928	7741	6886	Fiat: 46.736.886
VTO7063	9938	7797	46406010LH	Fiat: 46.817.666
VTO7064	9965	7750	1105	Fiat: 50.006.132
VTO7068C		7768CS	7069CS	Fiat: 4.427.068
VTO7068S	9972	7786	7069	Fiat: 4.427.069
VTO7070	9907	7732	3632	Fiat: 5.972.277
VTO7070CT	9906	7732CP	3632CP	Fiat: 5.972.277
VTO7071		7747	6109	Fiat: 5.997.325
VTO7071A		7745	6935	Fiat: 7.726.935
VTO7072	9980	7746	7325	Fiat: 599.732.5
VTO7074		7723	6013LH	Fiat: 7.083.589 / GM: 93.304.891
VTO7076	9914	1142	208025LH	Fiat: 7.702.173 - 46.424.716
VTO7077	9935	7735	6016LH	Fiat: 46.416.489
VTO7077C		7735CP	6016CS	Fiat: 46.416.489 - 46.415.744 - 46.415.746
VTO7078	9911	7737	6003LH	VW: 030.109.243.K
VTO7079	9912	7743	6005LHX	VW/ Seat: 036.109.243.J
VTO7080	9904	1129	FE177624	Agrale: 9.407.0.341.007.4/ Fiat: 500.344.132 Ford: 928FA228AB / BF9T10B300AA/Nissan /Troller: 9.407.0.341.0074MWM GM: 90.411.025 - 90.412.430 - 90.448.219 - 90.500.229 - 90.502.129 - MSB34101 MSB34102
VTO7080N	9915	1160	LH177026	Ford: 96BF6A228AB / WV / Seat: 030.145.299.C - 030.145.299.F Toyota: 16620.00020
VTO7081	9933	7792	6004LH	GM: 09.202.478 - 90.467.439 - 90.499.401 - 93.225.749
VTO7082	9901	7790	6006LH	GM/ Daewoo: 93.202.400
VTO7083	9976	7730	6341	Fiat: 46557953
VTO7084	9915	7742	4640	Fiat: 46.537.101/ GM: 90.412.884
VTO7085	9913	1144	108028LH	Fiat: 46.440.604
VTO7087	9908	1114-1152	FE177624	VW: 036.145.299
VTO7087N		1152	FE177624	VW: 036.145.299
VTO7088	9939	2054	4655	Fiat: 46.554.826
VTO7089	9927	2092	2180	VW/ Seat: 036.109.244.A
VTO7090	9926	1223	LH088030	GM: 90.409.238 - 93.297.272 - 93.310.600
VTO7091		1258	4021	Ford: 928M6K254AC
VTO7092	9925	1259	4022	Ford: 928M6M250BC
VTO7093	9924	1260	4023	Ford: 928M6M250DC
VTO7094	9937	7797	6010LH	GM: 09.158.004 - 90.411.774 - 90.530.125 - 90.528.603 - 90.530.126
VTO7095	9934	7793	6011LH	Fiat: 7.083.388 / GM: 09.128.516 - 90.412.783 - 90.530.123 - 09.128.656
VTO7096	9919	2040	1731	Fiat: 7.083.886 / GM: 09.128.740 - 90.412.731 - 90.570.913
VTO7097	9918	2039	1730	Fiat: 7.083.385 / GM: 09.128.739 - 90.412.730
VTO7098	9917	2041	1782	GM: 09.128.738 - 90.411.782
VTO8000		7801	9701	Ford / VW: 377.260.299
VTO8001		7802	9702	Ford/ VW: 377.145.299
VTO8002	99104	1111	FE177631	Ford/ VW: 377.145.299 B / 068.145.299
VTO8003	99113	1252	9704	Ford / VW: 377.145.299/ GM: MWM34101
VTO8006	99121	1239	LH106527	Fiat: 46.460.702/ Peugeot: 5751.52
VTO8009	9902	1125	FE177626CP	VW/ Audi: 032.145.276
VTO8010	9994	1133	FE177028CA	Fiat: 551.937.30 / 551.934.52
VTO8012	99120	1179	1776	Ford: 1S7Q19A216AB / 1S7Q19A216AC
VTO8013		7775	1921	Ford: XS6E 19A216BC / XS6E 19A216BB
VTO8021		7720	6007LH	Ford: 988M6K254AC - 988M6K254AD - 988M6K254AE
VTO8022		7721	5928	Ford: 928F6A228AB
VTO8025		7830	6032LH	Ford: 96MM6M250 AC
VTO8026		7826	6228	Ford: 96BF 6A228 AB
VTO8028	9960	1164	6250	Ford: XS7G6M250AA - XS7G6M250BA
VTO8034	9993	1169	086227LH	Ford: 96MM6M250AC



Rolamentos de Tensão - Tensores e Polias



VTO	Defabri	Nyton	Cobra	Original
VTO8035	9985	1115	FE177025	Ford: 2N1U10K018 BA
VTO8036	9922	1129-CP	FE177026CP	Ford: 928F6A228AB/ GM: 90.500.229 - 90.502.129
VTO8037	9916	1160-CP	177026CP	Ford: 96BF6A228AB
VTO8040	9953	1145	FE107030	Renault: 770.085.060.3
VTO8042		7817	1025	GM: 904.110.25
VTO8043	9920	2038	1783	GM: 90.411.773
VTO8046		7814	4496	GM: 933.848.13/ 933.744.96
VTO8048		7815	5229	GM: 905.002.29 / 905.021.29 / 933.754.64
VTO8049		7825	5216	GM: 90530764
VTO8050		7809	5310	GM: 90412884
VTO8055	9971	7794	7256	GM: 93397256
VTO8058	99114	7795	9330	GM: 551.920.180 / 552.013.640
VTO8059	9979	1155	LH088125	GM: 90.324.097
VTO8060	9921	2042	9810	GM: 90.529.810
VTO8062	9970	1139	FE177025	GM: 93374496
VTO8086		7769	6014LH	Peugeot/ Renault: 082986
VTO8087	9952	1150	LH085621	Peugeot/ Renault: 4003A3 / 820.004.016.1
VTO8088	99132	1244	LH107027	Peugeot: 575152
VTO8090	9989	1151	LH176026	Citroën/ Peugeot: 57.51.A2 / Renault: 770.010.293.1 / 770.010.287.2
VTO8093	99128	1235	1321	Peugeot/ Renault: 770.085.132.1
VTO8095	99151	1148	2612	Renault: 770.027.327.7 / 820.010.261.2
VTO8096		1147	5325	Renault: 770.087.532.5 / 820.019.284.3
VTO8097		7868	5916	Renault: 770.010.287.2
VTO8098	99111	1154	6224	Peugeot/ Renault: 820.013.622.4 / 820.043.473.2
VTO8099		7759	6017LH	Renault: 770.010.811.7
VTO8100	99131	7768	6021LH	Renault: 770.011.486.0 / 820.006.134.5 / 770.010.287.2
VTO8101	99109	1156	LH105432	Renault: 770.010.715.0
VTO8102		1149	6085	Renault: 770.073.608.5
VTO8103		1153		Renault: 770.010.862.6 / 770.087.532.5
VTO8104		1182		Renault: 820.006.466.4
VTO8108	9955	1173	LH077826	GM/ VW: 028.145.278E
VTO8109		7799	7765	Seat/ VW: 030.145.299C/ 030.145.299F
VTO8110		1120	8844	Toyota: 88440-17010
VTO8111	99105	1111	2971	VW: 027.260.297.1
VTO8112	9957	2053	2181	VW: 036.109.244.D
VTO8113	91115	7729	2182	Audi/ VW: 058.109.244
VTO8114	99100	1229	5285	VW: 5X0145285 / 028.145.299.1
VTO8115	9929	7749	6001LH	VW: 036.109.243.AB
VTO8117		7753	6000LH	VW: 036.109.243AC
VTO8118	9966	7781	9243	VW: 068.109.243.B
VTO8121	9992	1140	LH176624	VW: 030.145.299H
VTO8124		7822	6902	Fiat: 46.548.452/ 46.756.902
VTO8126	9997	1177	FE177025CP	Ford: YS4E19A216 AA / 95WF19A216 AC
VTO8127	9936	7796	6009LH	GM: 09.158.003 - 90.530.122 - 90.530.124 - 90.411.769/ Fiat: 7.085.784
VTO8129		1267		Citroën/ Peugeot: 57.51.50/ Renault: 77.00.851.321
VTO8134				Ford: E2333A840.010
VTO8136			LH176525	Peugeot: 963.620.74
VTO8145		2060	8835	Toyota: 88440-35030
VTO8147		7779	1354	Toyota: 13505-54020/ 13505-54021
VTO8151				Honda: 04145.PLC.315
VTO8161		7709	9330	Fiat: 55210364
VTO8178				Toyota: 13505.67041
VTO8182		7713	9443	Audi/ VW: 06B.109.243
VTO8184				Honda: 14510-PM7-003/004
VTO8185				Honda: 14510-P30-003
VTO8231				Peugeot: 57.51.91
VTO9243N		7782	2610	VW: 026.109.243 - 026.109.243E - 026.109.243.NAC
VTO9243PG	9903	7782	2610	Ford/ VW: 026.109.243 - 026.109.243E - 026.109.243.NAC



Rolamentos de Tensão - Tensores e Polias



Volkswagen Tensores



VTO7029 - VTO
Tensor - Correia Dentada
Fox , Golf, Polo 1.6 8V EA111,
Gol, Kombi, Voyage 1.0/1.4/1.6
8V, Power EA111
Dimensões: 60x27 cm



VTO7078 - VTO
9911 / 9911P - DEFABRI
Tensor - Correia Dentada
Gol e Parati AT 1.0 8V 96/98
Gol Special MI 1.0 96/02
Dimensões: 8,2x62x22 cm



VTO7079 - VTO
9912 - DEFABRI
Tensor - Correia Dentada
Gol, Parati AT 1.0 16V Turbo,
Polo
Dimensões: 8,2x60x26,9 cm



VTO8000 - VTO
Tensor Completo - Direção Hid.
Gol, Parati, Santana, Saveiro AP
1.6, 1.8, 2.0, 2.0 16V 96/... - c/ ar
Dimensões: 76,2x31 cm



VTO8001 - VTO
Tensor Completo - Direção Hid.
Gol, Parati, Santana, Saveiro AP
1.6, 1.8, 2.0, 2.0 16V 96/... - s/ ar
Dimensões: 76x21,8/ 76,2x31 cm



VTO8109 - VTO
Tensor - Alternador
Fox, Polo, 1.0 8V, 1.0 16V, 1.6
8V, Golf 1.6 EA111 01/...
Polo 1.0 16V/1.6 8V
Dimensões: 60x27 cm



VTO8115 - VTO
9929 / 9929P - DEFABRI
Tensor - Correia Dentada
Gol Power, Saveiro 16V 00/...
Dimensões: 8,2x60x24,4 cm



VTO8117 - VTO
Tensor - Correia Dentada
Gol, Parati (Power e Highway)
Polo AT 1.0 16V - cabeçote rotelado
Dimensões: 8,2x60x19 cm



VTO8182 - VTO
Tensor - Correia Dentada
Golf, Polo, Passat, New Beetle 1.8
20V Turbo
Dimensões: 72x23,6 pfs M10 cm



VTO9243PG - VTO
9903 / 9903P - DEFABRI
Tensor - Correia Dentada
Apollo, Gol, Logus, Parati, Pointer,
Polo Classic, Santana, Saveiro, Van,
Todos AP 1.6, 1.8/2.0, Golf Imp. 1.8/
2.0 94/98, Passat , Variant 2.0 94/97
Dimensões: 10,4x71,8x22,4 cm



VTO9243N - VTO
Tensor - Correia Dentada
Apollo, Gol, Logus, Parati, Saveiro,
Polo Classic, Santana, Van AP 1.6, 1.8/
2.0 Golf Imp. 1.8 /2.0 94/98, Passat,
Variant 2.0 94/97 - Nylon
Dimensões: 10,4x71,8x22,4 cm



Volkswagen Polias



VTO7030 - VTO
9942 / 9942P - DEFABRI
Polia Auxiliar - Alternador
Golf 1.8, 1.8T/2.0 98/... Bora,
Polo, New Beetle 1.8/2.0 98/...
Dimensões: 17x70x24 cm



VTO7031 - VTO
9905 / 9905P - DEFABRI
Polia Auxiliar - Alternador
Gol, Parati AT 1.0 8V/16V/16V
Turbo c/ direção e ar, Golf 1.6
EA111 c/ ar
Dimensões: 17x70x24 cm



VTO7080 - VTO
9904 / 9904P - DEFABRI
Polia Auxiliar - Alternador
Fox, Polo 1.0 8V/ 1.0 16V/ 1.6 8V,
Golf 1.6 EA111 01/... - s/ ar
Dimensões: 17x70x26 cm



VTO7080N - VTO
9915 / 9915P - DEFABRI
Polia Auxiliar - Alternador
Fox, Polo 1.0 8V/ 1.0 16V/ 1.6 8V,
Golf 1.6 EA111 01/... - s/ ar
Dimensões: 17x70x26 cm



VTO7087 - VTO
9908 / 9908P - DEFABRI
Polia Auxiliar - Alternador
Golf, Parati (AT 1.0
8V/16V/Turbo) c/ direção - Ferro
Dimensões: 17x76x24 cm



VTO7087N - VTO
Polia Auxiliar - Alternador
Golf, Parati (AT 1.0
8V/16V/Turbo) c/ direção - Nylon
Dimensões: 17x76x24 cm



VTO7089 - VTO
9927 / 9927P - DEFABRI
Polia Auxiliar - Correia Dentada
Gol, Parati (AT 1.0 16V/Turbo)
c/ direção - Nylon
Dimensões: 12,5x56x26 cm



Rolamentos de Tensão - Tensores e Polias

 <p>VTO8002 - VTO 99104 / 99104P - DEFABRI Polia - Tensor Gol, Parati, Santana, Saveiro AP 1.6/1.8/2.0/16V 96/... - c/ ar Dimensões: 17x76,2x31 cm</p>	 <p>VTO8003 - VTO Polia - Tensor Gol, Parati, Santana, Saveiro AP 1.6/1.8/2.0/16V 96/... - s/ ar Dimensões: 17x76x21,8 cm</p>	 <p>VTO8009 - VTO Polia Auxiliar - Alternador Fox, Polo 1.0 16V e 1.6 - c/ ar Dimensões: 70x26 pfs M10</p>	 <p>VTO8108 - VTO 9955 / 9955P - DEFABRI Polia Auxiliar - Alternador Golf 1.8 2.0 94/98, Passat, Variant 2.0 94/97, Polo Classic 1.8, Van 1.6 - c/ ar Dimensões: 78x26,8 cm</p>
 <p>VTO8111 - VTO Polia Auxiliar - Alternador Gol AE, CHT 1.0 93/96 c/ direção e ar Dimensões: 76,2x31 cm pfs M10</p>	 <p>VTO8112 - VTO Polia Auxiliar - Correia Dentada Gol, Parati (Power e Highway) Polo AT 1.0 16V 00 Dimensões: 66x21,9 cm pfs M10</p>	 <p>VTO8113 - VTO Polia Auxiliar - Correia Dentada Gol, Parati (Turbo, Power, Highway), Polo AT 1.0 16V, Passat, Variant 1.8/T 98/01 Dimensões: 8,3x28,3x29 cm</p>	 <p>VTO8114 - VTO Polia Auxiliar - Alternador Gol Special AT 1.0 8V s/ direção c/ ar, Gol, Parati, Saveiro 1.9 diesel exportação Dimensões: 74x24,5 cm pfs M10</p>
 <p>VTO8121 - VTO Polia Auxiliar - Alternador Fox, Polo 1.0 16V 02/... - c/ ar Dimensões: 17x65,7x23,6 cm</p>	 <p>9966 / 9966P - DEFABRI Tensor - Correia Dentada Kombi e Saveiro - Diesel Dimensões: 11,2x72x27 cm</p>	 <p>9957 / 9957P - DEFABRI Polia Inversão (maior) Correia Dentada Gol, Parati Power 1.0 00/... Polo 16V Dimensões: 56x22 cm pfs M10</p>	
 <p>Tensores ➔</p>	 <p>VTO7046 - VTO Tensor - Alternador Marea 2.0/2.4, Marea Weekend Dimensões: 65x24 cm</p>	 <p>VTO7047 - VTO Tensor - Correia Dentada Brava, Doblò, Palio, Siena, Strada 1.6 16V, Marea 01/... Dimensões: 8,2x60x29 cm</p>	 <p>VTO7049 - VTO Tensor - Correia Dentada Tempra 2.0 8V 90/96, Tempra SW 94/97, Tipo 2.0 8V 94/95 Dimensões: 10,3x60,2x25 cm</p>
 <p>VTO7051 - VTO Tensor Completo - Alternador Fiorino, Palio, Siena e Strada 99/... c/ motor 1.0 (exceto 6 marchas) e 1.5 Dimensões: 80,3x26 cm</p>	 <p>VTO7052 - VTO Tensor Completo - Alternador Doblò, Palio, Siena, Strada 1.8 8V 04/... Dimensões: 70x25 cm</p>	 <p>VTO7054 - VTO Tensor Completo - Alternador Stilo 1.8 8V e 16V Dimensões: 76,7x23 cm</p>	 <p>VTO7062 - VTO 9928 / 9928P - DEFABRI Tensor - Correia Dentada Fiorino, Palio, Siena, Strada, Uno Fire 8V Dimensões: 8,3x55,5x29 cm</p>



Rolamentos de Tensão - Tensores e Polias

 <p>VTO7063 - VTO Tensor - Correia Dentada Doblò, Siena, Palio, Idea Fire 16V Punto Fire 1.4 16V Dimensões: 8,2x60x29,2 cm</p>	 <p>VTO7068C - VTO Tensor Completo-Corr. Dentada 147 1050 e 1.3, Elba, Fiorino, Prêmio, Uno 1.3, Elba, Fiorino, Prêmio, Uno 1.5 91 Dimensões: 62,6x25,2 cm</p>	 <p>VTO7071 - VTO Tensor - Correia Dentada Tempra 2.0 8V 92/95 Dimensões: 10,5x59,5x26 cm</p>	 <p>VTO7071A - VTO Tensor - Correia Dentada Tempra 2.0 8V Turbo 96/98 Tempra 2.0 8V 96/99 Dimensões: 8,3x59,5x26 cm</p>
 <p>VTO7072 - VTO Tensor - Correia Dentada Tipo 2.0 16V 94/95, Tempra 2.0 16V 96/99, Coupe 2.0 16V 95/97, Uno 1.5/R 8V 87/89, Elba 1.5 8V 86/89, Prêmio 1.5 8V 85/89 Dimensões: 10,5x57,5x27 cm</p>	 <p>VTO7074 - VTO Tensor - Correia Dentada Stilo 1.8 16V Dimensões: 8,2x59x22 cm</p>	 <p>VTO7077 - VTO 9935 / 9935P - DEFABRI Tensor - Correia Dentada Brava, Doblò, Palio, Siena, Strada 1.6 16V Dimensões: 08x60x30 cm</p>	 <p>VTO7077C - VTO Tensor Completo-Corr. Dentada Brava, Doblò, Palio, Siena e Strada 1.6 16V 00/... (com suporte) Dimensões: 60x30 cm</p>
 <p>VTO7083 - VTO Tensor - Correia Dentada Fiorino, Palio, Siena, Strada, Uno (motor Fiasa 1.0 8V/ 1.5 8V) Dimensões: 8,4x60x23,9 cm</p>	 <p>VTO7095 - VTO Tensor - Correia Dentada Palio, Siena, Stilo e Strada 1.8 8V Dimensões: 8,2x59x22 cm</p>	 <p>VTO8124 - VTO Tensor Completo - Alternador Doblò, Fiorino, Palio, Siena, Strada e Uno Mille Fire 8V e 16V Dimensões: 65,7x23,6 cm</p>	 <p>VTO8127 - VTO Tensor - Correia Dentada Palio, Stilo, Strada, Doblò, Idea, Punto, Siena, Linea 1.8 8V 04/... Dimensões: 8,2x59x22 cm</p>
 <p>Polias ➔</p>	 <p>VTO7070 - VTO 9907 / 9907P - DEFABRI Polia Auxiliar - Correia Dentada s/ Cubo ➔ Descrição Dimensões: 30x58x24 cm</p>	 <p>VTO7070CT - VTO 9906 / 9906P - DEFABRI Polia Auxiliar - Correia Dentada c/ Cubo ➔ Descrição Dimensões: 30x58x24 cm</p>	<p>Elba 1.5 8v 91/96, Elba 1.6 8v 90/96, Fiorino 1.0 8v 94/96, Fiorino 1.5 8v 89/... Palio 1.0 e 1.6 8v 98/... Palio 1.5 8v 96/98, Prêmio 1.5 8v 91/94, Prêmio 1.6 8v 90/95, Siena 1.0 8v (6 marchas) 99/... Siena 1.5 8v 99/... Siena 1.6 8v 98/... Strada 1.5 8v e 1.6 8v 99/... Tipo 1.6 8v 93/97, Uno 1.0 8v 93/... Uno 1.4 8v Turbo 94/96, uno 1.5 8v 91/..., uno 1.6 8v 91/96, Uno 1.6R 8v 90/93</p>
 <p>VTO7058 - VTO Polia Auxiliar - Alternador Fiorino, Palio, Siena e Strada 1.0 e 1.5 (exceto 6 marchas) 99/... Dimensões: 17x80,3x26,3 cm</p>	 <p>VTO7060 - VTO Polia Auxiliar - Alternador Doblò, Palio, Siena, Strada, Uno Mille Fire 8V/16V (refil completo pfs, calço, arruela) Dimensões: 65,7x23,6 cm pfs M8</p>	 <p>VTO7061 - VTO 9940 / 9940P - DEFABRI Polia Auxiliar - Alternador Doblò, Palio, Siena, Strada, Uno Mille Fire 8V/16V (somente polia) Dimensões: 17x65,7x23,6 cm</p>	 <p>VTO7064 - VTO Polia Auxiliar - Correia Dentada Tempra 2.0 8V/ 2.0 8V Turbo 95/99, Tempra 2.0 16V 93/99 Dimensões: 8,3x65,8x30 cm</p>



Rolamentos de Tensão - Tensores e Polias



VTO7068S - VTO
9972 / 9972P - DEFABRI
Polia Auxiliar - Correia Dentada
 147 1050 e 1.3, Elba, Fiorino,
 Prêmio, Uno 1.3, Elba, Fiorino,
 Prêmio, Uno 1.5 91
Dimensões: 62,6x25,2 cm



VTO7076 - VTO
9914 / 9914P - DEFABRI
Polia Auxiliar - Alternador
 Uno 1.4 8V Turbo 95/96 - c/ ar
 Tipo 1.6 8V, Brava, Doblo, Palio,
 Siena, Strada 1.6 8V, 1.6 16v 00/...
Dimensões: 20x80x25 cm



VTO7080 - VTO
9904 / 9904P - DEFABRI
Polia Auxiliar - Alternador
 Ducato 2.8 e 2.8T 91/...
Dimensões: 17x70x26 cm



VTO7084 - VTO
9915 / 9915P - DEFABRI
Polia Auxiliar - Alternador
 Brava, Doblo, Palio, Siena,
 Strada 1.6 16V
Dimensões: 17x70x25 cm



VTO7085 - VTO
9913 / 9913P - DEFABRI
Polia Auxiliar - Alternador
 Fiorino, Strada, Uno 1.5 97/...
 Palio, Siena 1.0/ 1.5
Dimensões: 10,3x80x28 cm



VTO7088 - VTO
9939/ 9939P - DEFABRI
Polia Auxiliar - Correia Dentada
 Brava, Doblo, Palio, Siena, Marea,
 Strada 1.6 16V
Dimensões: 12,5x65x30,8 cm



VTO7096 - VTO
9919 / 9919P - DEFABRI
Polia Auxiliar - Correia Dentada
 Stilo 1.8 16V
Dimensões: 8,3x52,5x23,5 cm



VTO7097 - VTO
9918 / 9918P - DEFABRI
Polia Auxiliar - Correia Dentada
 Stilo 1.8 16V
Dimensões: 8,3x62,7x23,4 cm



VTO8006 - VTO
Polia Auxiliar - Alternador
 Marea 2.0 Turbo
Dimensões: 10,3x65x26,6 cm



VTO8010 - VTO
Polia Auxiliar - Alternador
 Doblo, Idea, Palio, Punto, Siena,
 Strada 1.8 8V
Dimensões: 17x70x25 cm



VTO8161 - VTO
Polia Auxiliar - Alternador
 Doblo, Idea, Punto, Stilo 1.8 8V
Dimensões: 56x25 cm pfs M8



9948 / 9948P - DEFABRI
Polia Auxiliar - Alternador
 Stilo 1.8 8V/16V
Dimensões: 17x78x23 cm



GM

Tensores



VTO7054 - VTO
Tensor Completo - Alternador
 Novo Corsa, Meriva - c/ direção mod.
Dimensões: 76,7x23 cm



VTO7074 - VTO
Tensor - Correia Dentada
 Novo Corsa, Meriva, Montana 1.8
 8V/16V 03/04
Dimensões: 8,2x59x22 cm



VTO7081 - VTO
9933 / 9933P - DEFABRI
Tensor - Correia Dentada
 Corsa, Celta 1.0/1.6 8V 05/...
 Novo Corsa 1.0 8V 02/05
Dimensões: 8,2x58,6x19 cm



VTO7082 - VTO
9901 / 9901P - DEFABRI
Tensor Completo-Corr. Dentada
 Kadett, Ipanema, Monza 89/95
Dimensões: 71,8x22 cm



VTO7094 - VTO
9937 / 9937P - DEFABRI
Tensor - Correia Dentada
 Astra, Calibra, Vectra, Zafira
 2.0/2.2/2.4 16V
Dimensões: 8,2x58x26 cm



VTO7095 - VTO
9934 / 9934P - DEFABRI
Tensor - Correia Dentada
 Corsa 1.0/1.6 16V, Tigra 1.6 16V
Dimensões: 8,2x59x22 cm



VTO8042 - VTO
Tensor Completo - Direção Hid.
 Corsa 95/... Celta, Prisma -
 c/ direção s/ ar
Dimensões: 70x26 cm



Rolamentos de Tensão - Tensores e Polias

 <p>VTO8046 - VTO Tensor - Direção Hidráulica Novo Corsa, Meriva, Montana direção convencional Dimensões: 70x22 cm</p>	 <p>VTO8048 - VTO Tensor Completo - Direção Hid. Astra, Zafira (c/ direção eletro-hid.), Calibra (tds), Celta, Corsa (c/ ar), Omega (tds motor 2.2L), Vectra (tds alter. 70AMP) 94/... Dimensões: 70x26 cm</p>	 <p>VTO8049 - VTO Tensor - Alternador Astra 2.0 MPFI 16V 99/... Astra 2.0 MPFI 8V 02/... c/ direção eletro-hid. Dimensões: 70x24 cm</p>	 <p>VTO8050 - VTO Tensor - Alternador Corsa 1.0/1.6 16V 99/... Celta 1.0/1.6 16V - s/ direção s/ ar Dimensões: 70x25 cm</p>
 <p>VTO8127 - VTO 9936 / 9936P - DEFABRI Tensor - Correia Dentada Astra, Vectra, Zafira 8V, Celta, Blazer, S10 2.2 EFI/ 2.2 MPFI 8V 95/00 2.4 MPFI, Kadett, Ipanema 1.8/2.0 95/96, Omega. Suprema 2.0 8V/ 2.2 8V 93/98, Corsa, Meriva 1.8 8V/16V Dimensões: 8,2x59x22 cm</p>	<p><i>VTO6821 NÃO serve p/VTO6821S10</i></p>  <p>VTO6821 - VTO 9909 / 9909P - DEFABRI Tensor - Correia Dentada Chevette, Chevy, Marajó Dimensões: 8,3x81,8x20 cm</p>	<p><i>VTO6821S10 serve p/VTO6821</i></p>  <p>VTO6821S10 - VTO 9909 / 9909P - DEFABRI Tensor - Correia Ar Condicionado Blazer, S10 2,5 HSD, Blazer, S10 2.2 95/00, Kadett, Monza 2.0 MPFI 91/93 Correia do ar e direção Dimensões: 8,3x81,6x23 cm</p>	
 <p>GM</p> <p>Polias</p> 	 <p>VTO7015 - VTO 9949 / 9949P - DEFABRI Polia Auxiliar - Alternador Blazer e S10 4.3 V6 96/... Dimensões: 17x69,5x21,8 cm</p>	 <p>VTO7017 - VTO 9948 / 9948P - DEFABRI Polia Auxiliar - Alternador Novo Corsa, Meriva 1.8 8V/16V Dimensões: 17x76,7x23 cm</p>	 <p>VTO7019 - VTO Polia Auxiliar - Alternador Omega, Suprema 3.0 Dimensões: 17x80x26 cm</p>
 <p>VTO7022 - VTO Polia Auxiliar - Alternador Astra, Zafira 1.8/2.0 8V/16V 00/03 c/ direção Hid. Convencional Dimensões: 17x65x26 cm</p>	 <p>VTO7030 - VTO 9942 / 9942P - DEFABRI Polia Auxiliar - Alternador Astra, Zafira 2.0 8V/ 16V c/ direção eletro-hid. Dimensões: 17x70x24 cm</p>	 <p>VTO7080 - VTO 9904 / 9904P - DEFABRI Polia Auxiliar - Alternador Astra, Calibra, Vectra, Zafira, Blazer, S10 2.8 Turbo, Celta, Corsa (c/ ar), Omega 2.2 MPFI 8V 95/00 Dimensões: 17x70x26 cm</p>	 <p>VTO7080N - VTO Polia Auxiliar - Alternador Astra, Calibra, Vectra, Zafira, Blazer, S10 2.8 Turbo, Celta, Corsa (c/ ar), Omega 2.2 MPFI 8V 95/00 Nylon Dimensões: 17x70x26 cm</p>
 <p>VTO7084 - VTO Polia Auxiliar - Alternador Corsa 16V 99/... - s/ direção s/ ar Dimensões: 17x70x25 cm</p>	 <p>VTO7090 - VTO 9926 / 9926P - DEFABRI Polia Auxiliar - Alternador Omega, Suprema 3.0, Celta, Corsa c/ ar Dimensões: 8,3x76x22,7 cm</p>	 <p>VTO7096 - VTO 9919 / 9919P - DEFABRI Polia Auxiliar - Correia Dentada Corsa 1.0/1.6, Tigra 16V, Meriva 1.8 16V Dimensões: 8,3x52,5x23,5 cm</p> <p>MEHOR</p>	 <p>VTO7097 - VTO 9918 / 9918P - DEFABRI Polia Auxiliar - Correia Dentada Corsa 1.0/1.6, Tigra 16V, Meriva 1.8 16V Dimensões: 8,3x62,7x23,4 cm</p> <p>MAIOR</p>



Rolamentos de Tensão - Tensores e Polias



VTO8003 - VTO
Polia - Tensor Alternador
 Silverado, Grand Blazer, 3500 HD,
 GCM 6-140 /6-150 (MWM 4.2
 Turbo 6.07T)
Dimensões: 17x88,5x29 cm



VTO8036 - VTO
9922 / 9922P - DEFABRI
Polia - Tensor Alternador
 (c/ Parafuso e Bucha)
 Corsa, Celta (c/ar), Omega 2.2 8V,
 Vectra, Astra, Zafira,
 Calibra 2.0 16V
Dimensões: 70x26 cm pfs M8



VTO8055 - VTO
Polia Auxiliar - Direção Hid.
 Novo Corsa, Meriva 1.8 8V/16V
 02/03, Corsa 1.0 (c/ ar e direção),
 Corsa 1.6, Montana 04/...
Dimensões: 64,6x24,6 cm pfs M8



VTO8058 - VTO
99114 / 99114P - DEFABRI
Polia Auxiliar - Direção Hid.
 Novo Corsa, Meriva 1.8 8V/16V
 03/... Astra 1.8/2.0 8V 04/...
Dimensões: 56x25 cm pfs M8



VTO8062 - VTO
Polia Auxiliar - Alternador
 Novo Corsa, Meriva, Montana 1.8
 8/16V 02/...-c/ direção Hid. Conv.
Dimensões: 17x70x22 cm



9917 / 9917P - DEFABRI
Polia Auxiliar - Correia Dentada
 Calibra, Vectra 2.0 16V
 94/96 e 97/...
Dimensões: 10,3x54x27,5 cm



9920 / 9920P - DEFABRI
Polia Auxiliar - Correia Dentada
 Calibra, Vectra 2.0 16V 94/96
Dimensões: 8,2x62,7x27,5 cm



9921 / 9921P - DEFABRI
Polia Auxiliar - Correia Dentada
 Astra, Zafira 2.0 16V
Dimensões: 10,2x54x27,5 cm



9923 / 9923P - DEFABRI
Polia - Tensor Alternador
 (c/ Parafuso e Bucha)
 Blazer, S10 2.8T - c/ ar
Dimensões: 70x26 cm pfs M8



9930 / 9930P - DEFABRI
Polia Auxiliar - Alternador
 (Estriada)
 Blazer, S10 2.8 Turbo - s/ar
 Omega 3.8
Dimensões: 75x17x22 cm



9979 / 9979P - DEFABRI
Polia Auxiliar - Alternador
 Omega, Suprema 3.0 93/94
Dimensões: 8,2x82x26 cm



Ford

Tensores



VTO6821S10 - VTO
9909 / 9909P - DEFABRI
Tensor - Correia Ar Cond.
 Ranger, F-1000 2.5 HSD 96/98 - c/ ar
Dimensões: 8,3x 81,6x23 cm



VTO7091 - VTO
Tensor - Correia Dentada
 Escort 1.8 16V Zetec,
 Mondeo 1.8 e 2.0 16V Zetec 94/98
 Focus 16V Zetec
Dimensões: 86,8x31 cm



VTO8000 - VTO
Tensor Completo-Alternador
 Versailles, Royale AP 95/96
 c/ direção e ar
Dimensões: 76x31 cm



VTO8001 - VTO
Tensor Completo-Alternador
 Versailles, Royale AP 95/96
 c/ direção s/ ar
Dimensões: 76,2x21-76x31cm

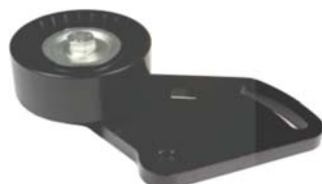

VTO8013 - VTO
Tensor Completo - Alternador
 Fiesta, Ka, Courier 1.0/1.6 Rocam
 s/ direção s/ ar
Dimensões: 70x25 cm



VTO8021 - VTO
Tensor - Correia Dentada
 Focus 1.8 e 2.0 16V Zetec - Todos
 Mondeo 2.0 16V Zetec 98/01
Dimensões: 8,2x60x29 cm



VTO8022 - VTO
Tensor - Alternador
 Escort 1.8 16V Zetec
Dimensões: 70x26 cm



Rolamentos de Tensão - Tensores e Polias



VTO8025 - VTO
Tensor - Correia Dentada
Fiesta 1.4 16V Zetec 96/98,
Courier 1.4 16V Zetec 97/98
Dimensões: 62x26,8 cm



VTO8026 - VTO
Tensor Completo - Alternador
Fiesta 96/99, Ka 97/99, Courier
97/99 1.0/1.3 - Endura E/ Direção
Dimensões: 70x26 cm



VTO8134 - VTO
Tensor - Alternador
Fiesta, Courier, Focus 1.6 8v Refil
Dimensões: 69,9x25 cm



VTO9243PG - VTO
9903 / 9903P - DEFABRI
Tensor - Correia Dentada
Del Rey, Escort, Pampa, Royale,
Verona, Versailles Todos Motor AP
Dimensões: 10,4x71,8x22,4 cm



Ford

Polias



VTO7015 - VTO
9949 / 9949P - DEFABRI
Polia Auxiliar - Alternador
Courier, Fiesta, Ka Zetec Rocan,
Focus 1.8 e 2.0 16v Zetec 00/05,
Ecosport 2.0 16v Duratec, Explorer
XLT 97 Mondeo 2.0 16v Zetec 98/01
Dimensões: 17x69,5x21,8 cm



VTO7055 - VTO
Polia Auxiliar - Alternador
Fiesta, Courier, Ka 1.0/1.6 Rocan
c/ ar s/ direção
Dimensões: 69,5x21,8 cm pfs M8



VTO7080 - VTO
9904 / 9904P - DEFABRI
Polia Auxiliar - Alternador
Escort Zetec 1.8 16v, F-250
(MWM 6.07TCA)
Dimensões: 17x70x26 cm



VTO7080N - VTO
9915 / 9915P - DEFABRI
Polia Auxiliar - Alternador
Courier, Escort, Fiesta, Ka
c/ direção
Dimensões: 17x70x26 cm



VTO7092 - VTO
9925 / 9925P - DEFABRI
Polia Auxiliar - Correia Dentada
Escort 1.8, Mondeo 1.8/2.0 16V
Zetec 94/98
Dimensões: 10,3x60,5x29,1 cm



VTO7093 - VTO
9924 / 9924P - DEFABRI
Polia Auxiliar - Correia Dentada
Escort 1.8 16V Zetec,
Mondeo 1.8 e 2.0 16V Zetec 94/98
Dimensões: 10,3x48,2x29,2 cm



VTO8002 - VTO
99104 / 99104P - DEFABRI
Polia - Tensor
Versailles e Royale AP 95/96-c/ ar
Dimensões: 17x76x31 cm

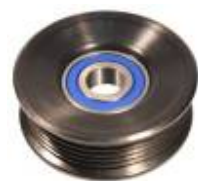

VTO8003 - VTO
Polia - Tensor
Versailles e Royale AP 95/96-s/ ar
Dimensões: 17x76x21 cm



VTO8012 - VTO
Polia Auxiliar - Alternador
Mondeo 2.0 16V Duratec 01/...
Ecosport 2.0 16V Duratec- c/ ar
Fusion 2.3 Duratec
Dimensões: 76,2x31 cm pfs M8



VTO8028 - VTO
Polia Auxiliar - Correia Dentada
Focus 1.8 e 2.0 16V Zetec
Mondeo 2.0 16V Zetec 99/01
Dimensões: 60x29,5 cm pfs M8



VTO8034 - VTO
Polia Auxiliar - Correia Dentada
Fiesta 1.4 16v Zetec 96/98, Courier
1.4 16v Zetec 97/98
Dimensões: 8,3x62x26,8 cm



VTO8035 - VTO
Polia Auxiliar - Alternador
Fiesta, Ecosport 1.0 Supercharger,
Courier, Focus 1.6 16V
Dimensões: 17x70,1x24,5 cm



VTO8036 - VTO
9922 / 9922P - DEFABRI
Polia Auxiliar - Alternador
(c/ Parafuso e Bucha)
Escort 1.8 16V Zetec
Dimensões: 70x26 cm pfs M8



VTO8037 - VTO
9916 / 9916P - DEFABRI
Polia Auxiliar - Alternador
(c/ Parafuso e Bucha)
Fiesta 96/99, Ka 97/99, Courier
97/99 Todos 1.0/1.3
Endura-E c/ direção
Dimensões: 70x26 cm pfs M8



VTO8126 - VTO
Polia Auxiliar - Alternador
Fiesta, Ka, Courier 1.0/1.6 Zetec Rocan
(c/ ar ou direção usam 2 peças), Ka 1.0/
1.3 Endura E (c/ ar), Fiesta, Courier
1.0/1.3 Endura E (c/direção)/1.4 16V (s/
ar s/ direção), Ecosport 1.6 Zetec Rocan,
Escort 1.8 16V Zetec
Dimensões: 60x29 cm pfs M8



Rolamentos de Tensão - Tensores e Polias

 <p>9923 / 9923P - DEFABRI Polia Auxiliar - Alternador (c/ Parafuso e Bucha) F-250 MWM - c/ ar Dimensões: 70x26 cm</p>	 <p>9930 / 9930P - DEFABRI Polia Estriada do Alternador F-250 (MWM 6.07TCA) - s/ ar Dimensões: 17x74x24,5 cm</p>	 <p>Agrale</p> <p>Polias</p> 	 <p>VTO7080 - VTO 9904 / 9904P - DEFABRI Polia Auxiliar - Alternador Volare (2.8 Diesel) - c/ direção Dimensões: 17x70x26 cm</p>
 <p>9923 / 9923P - DEFABRI Polia - Tensor Alternador (c/ Parafuso e Bucha) Volare 00/... - c/ ar Dimensões: 70x26 cm pfs M8</p>	 <p>9930 / 9930P - DEFABRI Polia Estriada do Alternador Volare - s/ ar Dimensões: 17x74x24,5 cm</p>	 <p>Audi</p> <p>Tensores e Polias</p> 	 <p>VTO7029 - VTO 9910 / 9910P - DEFABRI Tensor - Correia Dentada A3 1.6 EA111 02/... Dimensões: 8,2x60x27 cm</p>
 <p>VTO7030 - VTO 9942 / 9942P - DEFABRI Polia Auxiliar - Alternador A3 1.6 99/00, A3 1.8/ 1.8T Todos Dimensões: 17x70x24 cm</p>	 <p>VTO7031 - VTO 9905 / 9905P - DEFABRI Polia Auxiliar - Alternador A3 1.6 00/... - c/ direção e ar Dimensões: 17x70x24 cm</p>	 <p>VTO8009 - VTO Polia Auxiliar - Alternador A3 1.6 02/... - c/ ar Dimensões: 76x26 pfs M8 cm</p>	 <p>VTO8113 - VTO Polia Auxiliar - Correia Dentada A2 8Z0 1.6 FSI Dimensões: 8x28,3x29 cm</p>
 <p>VTO8182 - VTO Tensor - Correia Dentada A3 1.8 96/... A4 1.8T 00/... TT 1.8T 98/... Dimensões: 72x23,6 pfs M10 cm</p>	 <p>Tensores e Polias</p> 	 <p>VTO7009 - VTO Polia Auxiliar - Alternador 316, 318, 325, 525 (alt. 80 AMP) 93/00 M3 3.0/3.2, Z3 2.8 Dimensões: 10,3x70x24,5 cm</p>	 <p>VTO7025 - VTO Tensor - Alternador 318, 325, 525 (alt. 70AMP) 93/00 M3 3.0/3.2, Z3 2.8 Dimensões: 10,3x79,9x26,4 cm</p>
 <p>Citroën</p> <p>Tensores</p> 	 <p>VTO7034 - VTO Tensor - Correia Dentada Berlingo 1.8 8V, Xantia 2.0, ZX 1.8/ 2.0 8V Dimensões: 13x59x22,2 cm</p>	 <p>VTO7038 - VTO Tensor - Correia Dentada ZX 1.6/1.8 XU7 Dimensões: 13x59x22 cm</p>	 <p>VTO7039 - VTO Tensor - Correia Dentada C3, Xsara 1.6 16V, Berlingo Dimensões: 8,2x70x30 cm</p>



Rolamentos de Tensão - Tensores e Polias

 <p>VTO7059 - VTO Tensor - Correia Dentada C3 1.4 8V (corr. de 104 dentes) Dimensões: 8,2x92x29,5 cm</p>	 <p>Citroën</p> <p>Polias</p> 	 <p>VTO7041 - VTO Polia Auxiliar - Alternador Xsara 1.6 16V 01/... Dimensões: 10,2x60x26,5 cm</p>	 <p>VTO7043 - VTO Polia Auxiliar - Correia Dentada Picasso 2.0 16V, C4, C5, C8 16V EW10 Dimensões: 10,2x60x31 cm</p>
 <p>VTO7044 - VTO Polia Auxiliar - Correia Dentada Xsara 1.6 16V, C3 1.6 03/... Dimensões: 8,3x57x32 cm</p>	 <p>VTO7045 - VTO Polia Auxiliar - Alternador Xantia e Xsara 1.8 16V Dimensões: 17x90,5x25 cm</p>	 <p>VTO8090 - VTO Polia - Alternador C31.6 16V 01/...- c/ ar Dimensões: 17x60,3x26 cm</p>	 <p>VTO8129 - VTO Polia - Direção Hidráulica Berlino, Xsara 1.6 16V, C3 1.4 Dimensões: 70x27 cm</p>
 <p>Daewoo</p> <p>Tensor</p> 	 <p>VTO7082 - VTO Tensor Completo-Corr. Dentada Espero 1.8 2.0 94/97, Neixa 1.8 98/... Dimensões: 71,8x22 cm</p>	 <p>Honda</p> <p>Tensores e Polias</p> 	 <p>VTO7019 - VTO Polia Auxiliar - Alternador Fit Dimensões: 17x80x26 cm</p>
 <p>VTO8151 - VTO Tensor - Correia Dentada Civic 1.7 01/... Dimensões: 55x24 cm</p>	 <p>VTO8184 - VTO Tensor - Correia Dentada Civic 1.6 LX importado 93x95 Dimensões: 57x26 cm</p>	 <p>VTO8185 - VTO Tensor - Correia Dentada Civic 1.6 VTI comando duplo 98/... Dimensões: 55x30 cm</p>	
 <p>Mercedes-Benz</p> <p>Polias</p> 	 <p>VTO6821S10 - VTO 9909 / 9909P - DEFABRI Polia - Ar Condicionado Sprinter 2.5 HSD Maxion Dimensões: 8,3x81,6x23 cm</p>	 <p>VTO7017 - VTO 9948 / 9948P - DEFABRI Polia Auxiliar - Alternador Classe A 1.60 e 1.90 Dimensões: 17x76,7x23 cm</p>	



Rolamentos de Tensão - Tensores e Polias

 <p>Nissan</p> <p>Polias</p> 	 <p>VTO7080 - VTO 9904 / 9904P - DEFABRI Polia Auxiliar - Alternador Frontier, XTerra 2.8 Turbo Dimensões: 17x76x17,5 cm</p>	 <p>VTO7080N - VTO Polia Auxiliar - Alternador Frontier, XTerra 2.8 Turbo - Nylon Dimensões: 17x70x26 cm</p>	 <p>9923 / 9923P - DEFABRI Polia - Tensor Alternador (c/ Parafuso e Bucha) Volare 00/... - c/ ar Dimensões: 70x26 cm pfs M8</p>
 <p>9930 / 9930P - DEFABRI Polia Estriada do Alternador Frontier, XTerra 2.8 Turbo Dimensões: 17x74x24,5 cm</p>	 <p>Peugeot</p> <p>Tensores</p> 	 <p>VTO7034 - VTO Tensor - Correia Dentada 106 , 205 1.0/1.1/1.3/1.4, 306 1.6 8V Dimensões: 12,7x59x22,2 cm</p>	 <p>VTO7038 - VTO Tensor - Correia Dentada 306,405,605,806, Partner 1.8 8V, 206 1.6 8V, 206 1.4 8V (correia 108 dentes) Dimensões: 13x59x22 cm</p>
 <p>VTO7039 - VTO Tensor - Correia Dentada 206, 307, 207, Partner 1.6 16V Dimensões: 8,2x70x31,5 cm</p>	 <p>VTO7059 - VTO Tensor - Correia Dentada 206 1.4 8V,207 (correia 104 dentes) Dimensões: 62x29,5 cm</p>	 <p>VTO8086 - VTO Tensor - Correia Dentada 206 1.0 16V Dimensões: 8,2x59,1x28,3cm</p>	 <p>VTO8093 - VTO Tensor - Alternador 206 1.4 8V - Nylon Dimensões: 70x27 cm</p>
 <p>VTO8129 - VTO Tensor - Alternador 206 1.4 8V - Ferro Dimensões: 70x27 cm</p>	 <p>Peugeot</p> <p>Polias</p> 	 <p>VTO7041 - VTO Polia Auxiliar - Alternador 206 1.6 16V 01/... 206E 1.4 8V 01/... Dimensões: 10,2x60x26,5 cm</p>	 <p>VTO7043 - VTO Polia Auxiliar - Correia Dentada 307, 406 2.0 16V EW 10 Dimensões: 10,2x60x31cm</p>
 <p>VTO7044 - VTO Polia Auxiliar - Correia Dentada 206, 307 1.6 16V Dimensões: 8,3x60x32 cm</p>	 <p>VTO7045 - VTO Polia Auxiliar - Alternador 306, 405, 406 Dimensões: 17x90,5x25 cm</p>	 <p>VTO8006 - VTO Polia Auxiliar - Alternador 206 1.6 8V, 206, 307 1.6 16V Dimensões: 10,3x65x26,6 cm</p>	 <p>VTO8087 - VTO Polia Auxiliar - Correia Dentada 206 1.0 16V - c/ direção Dimensões: 8,2x56,2x21cm</p>



Rolamentos de Tensão - Tensores e Polias

 <p>VTO8088 - VTO Polia Auxiliar - Alternador 206, 207, 307 1.4 8V/1.6 16V Dimensões: 10,3x70x27cm</p>	 <p>VTO8090 - VTO Polia Auxiliar - Alternador 206 1.6 16V 01/...- c/ ar Dimensões: 17x60,3x26,1 cm</p>	 <p>VTO8098 - VTO Polia Auxiliar - Alternador 206 1.0 16V Dimensões: 10,2x56,24 cm</p>	 <p>VTO8136 - VTO Polia - Tensor 206, 307, 407 2.0 16V Dimensões: 17x65x25 cm</p>
<p>imagem não disponível</p>  <p>VTO8231 - VTO Polia - Alternador 206, 207, 307 1.4 8V 1.6 16V Dimensões: 8,2x60x26,5 cm</p>	 <p>Renault Tensores</p> 	 <p>VTO8086 - VTO Tensor - Correia Dentada Clio, Kangoo, Sandero, Logan 1.0 16V Dimensões: 8,2x59,1x28,3cm</p>	 <p>VTO8093 - VTO Tensor - Alternador R19, R19 RTI 1.8 8V/1.8 16V, Laguna, Megane, Scenic 2.0 8V Dimensões: 70x27 cm</p>
 <p>VTO8095 - VTO Tensor - Correia Dentada Clio, Kangoo, Megane 1.6 8V Dimensões: 10,2x55x21,9 cm</p>	 <p>VTO8096 - VTO Tensor Completo - Alternador Clio, Kangoo, Scenic 1.6 8V/16V s/ ar Dimensões: 70x25,5 cm</p>	 <p>VTO8097 - VTO Tensor Completo - Alternador Clio, Kangoo, Megane, Laguna, Scenic 1.6 8V, 1.6 16V, Megane, Scenic 2.0 16V - c/direção e ar Dimensões: 70x26 cm</p>	 <p>VTO8099 - VTO Tensor - Correia Dentada Clio, Megane, Scenic 1.6 16V, Logan, Kangoo, Sandero, Symbol 1.6 16V Dimensões: 8,2x65,6x32 cm</p>
 <p>VTO8100 - VTO Tensor - Correia Dentada Megane, Scenic 2.0 16V Dimensões: 8,2x65,6x32 cm</p>	 <p>VTO8102 - VTO Tensor - Correia Dentada Clio, Kangoo 1.0 8V, Twingo Dimensões: 10,2x50x21,9 cm</p>	 <p>VTO8129 - VTO Tensor - Alternador Megane, Scenic 2.0 8V, Laguna, R19 1.8 8V/16V Dimensões: 70x27 cm</p>	
 <p>Renault Polias</p> 	 <p>VTO8040 - VTO Polia Auxiliar - Alternador Nevada, R19/R21, Clio, Twingo - c/ ar Dimensões: 10,3x70x30 cm</p>	 <p>VTO8087 - VTO Polia Auxiliar - Alternador Clio, Kangoo 1.0 16V c/ direção e ar Dimensões: 8,2x56,2x21cm</p>	 <p>VTO8090 - VTO Polia Auxiliar - Alternador Clio, Kangoo, Megane, Laguna, Scenic 1.6 8V/1.6 16V/2.0 16V c/ direção e ar, Trafic 2.0 8V Dimensões: 17x60x25,6 cm</p>



Rolamentos de Tensão - Tensores e Polias

 <p>VTO8098 - VTO Polia Auxiliar - Alternador Clio, Kangoo, Twingo 1.0 8V 00/... Kangoo 1.0 16V Tds, Logan, Sanderó Dimensões: 10,2x56x24 cm</p>	 <p>VTO8101 - VTO Polia Auxiliar - Correia Dentada Clio, Megane, Scenic 1.6 16V Tds, Megane, Scenic 2.0 16V 01/... Logan Kangoo, Sanderó 1.6 16V, Symbol Dimensões: 10,5x54x32,8 cm</p>	 <p>VTO8103 - VTO Polia Auxiliar - Correia Dentada Megane, Scenic 2.0 16V 01/... Dimensões: 17x54x32 cm (Atenção: observar código original, aplicação igual VTO8104)</p>	 <p>VTO8104 - VTO Polia Auxiliar - Correia Dentada Megane, Scenic 2.0 16V 01/... Dimensões: 17x54x32 cm (Atenção: observar código original, aplicação igual VTO8103)</p>
 <p>Seat Tensores e Polias ➔</p>	 <p>VTO7030 - VTO 9942 / 9942P - DEFABRI Polia Auxiliar - Alternador Cordoba, Ibiza, 1.6 8V 99/... Dimensões: 17x70x24 cm</p>	 <p>VTO7079 - VTO Tensor - Correia Dentada Cordoba, Ibiza 1.0 16V Dimensões: 8,2x60x26,9 cm</p>	 <p>VTO7080 - VTO 9904 / 9904P - DEFABRI Polia Auxiliar - Alternador Ibiza 1.0 16V 00/03, Ibiza 1.6 8V 00/03Cordoba 1.6 8V 00/03 Dimensões: 17x70x26 cm</p>
 <p>VTO7080N - VTO Polia Auxiliar - Alternador Ibiza 1.0 16V 00/03, Ibiza 1.6 8V 00/03 Cordoba 1.6 8V 00/03 Nylon Dimensões: 17x70x26 cm</p>	 <p>VTO7089 - VTO 9927 / 9927P - DEFABRI Polia Auxiliar - Correia Dentada Cordoba, Ibiza 1.0 16V Dimensões: 12,5x56x26 cm</p>	 <p>VTO8108 - VTO 9955 / 9955P - DEFABRI Polia Auxiliar - Alternador Cordoba e Ibiza 1.8 95/99 Dimensões: 78x26,8 cm</p>	 <p>VTO8109 - VTO Tensor Completo - Alternador Ibiza 1.0 16V 00/03 Dimensões: 70x26 cm</p>
 <p>Toyota Tensores ➔</p>	 <p>VTO7003 - VTO Tensor - Correia Dentada Corolla 1.8 16V 92/02 Corolla 1.6 16V 91/00 Dimensões: 58x25 cm</p>	 <p>VTO8147 - VTO Tensor - Correia Dentada Hilux 2.4/2.8/3.0 Dimensões: 62x35 cm</p>	
 <p>Toyota Polias ➔</p>	 <p>VTO7080N - VTO Polia Auxiliar - Direção Hid. Corolla 1.6/1.8 16V 01/... Dimensões: 17x70x26 cm</p>	 <p>VTO8110 - VTO Polia Auxiliar - Alternador Corolla 1.8 16V 98/02 Dimensões: 70x15,5 cm</p>	 <p>VTO8145 - VTO Polia Auxiliar - Alternador Hilux 2.4/2.8/3.0 92/... Dimensões: 83x12,7 cm</p>



Rolamentos de Tensão - Tensores e Polias



VTO8178 - VTO
Polia - Tensor
 Hilux SW4 2.5/3.0 TD, 3.0 D4D
 Land Cruiser Prado 3.0 TD 97/...
Dimensões: 62x28,5 cm



Troller

Polias



VTO7080 - VTO
9904 / 9904P - DEFABRI
Polia Auxiliar - Alternador
 Troller 2.8 turbo MWM
Dimensões: 17x70x26 cm



VTO7080N - VTO
Polia Auxiliar - Alternador
 Troller 2.8 turbo
Dimensões: 17x70x26 cm



9923 / 9923P - DEFABRI
Polia Auxiliar - Alternador
 (c/ Parafuso e Bucha)
 F-250 MWM - c/ ar
Dimensões: 70x26 cm



9930 / 9930P - DEFABRI
Polia Estriada do Alternador
 Troller 2.8 Turbo - s/ ar
Dimensões: 17x74x24,5 cm





NV-151



Calota Cubo Roda Traseira
Linha VW exceto Gol G5/G6 e Fox

LA 479



Kit Calota Cubo Roda Traseira
Linha VW (NV-151 + 3 pçs)

NV-154



Calota do Cubo de Roda
Chevette 73/94 (Dianteira)
Monza, Kadett, Corsa 99/ Celta (Traseira)

NV-160



Calota do Cubo da Roda Traseira
Palo, Siena, Marea

NV-245



Calota Cubo de Roda Traseira
Uno, Elba, Premio, Fiorino 88/93 Fiat 147

LA 940



Calota Cubo Roda Traseira
Peugeot 206/207 e Citroën C3

NV-242



Calota Cubo Roda Traseira
Gol G5/G6, Fox, Polo, Bora, Golf, Audi

NV-153



Calota Cubo Roda Traseira
Escort 93/... Fiesta, Verona
Logus, Pointer 93/96

LA 435



Conexão do Coletor de Admissão
Monza 91/... (em Alumínio)

LA 437



Conexão da Válvula Termostática
Uno EVO 1.0/1.4 Fire 8V (M18x1,5)

CV-001



Carvão com Mola p/ Tampa do
Distribuidor Bosch 4,8mm
Marca: Olimpic - Pacote c/ 10 pçs

CV-002



Carvão com Mola p/ Tampa do
Distribuidor Wapsa 6,38mm
Marca: Olimpic - Pacote c/ 10 pçs

GB 1023



Buzina Caracol Individual
Gol G5, Fox, Polo, Golf
Modelo Original - Marca: Gauss

TNC 0124



Chicote Distribuidor VW 7 Pinos
Chicote Nacional 1º Linha

H-1000



Kit Emergência Fusível Lâmina
2 peças de cada (10/15/20/25/30 AMP)
Marca: Hikari

H-2000



Kit Emergência Fusível Mini Lâmina
2 peças de cada (10/15/20/25/30 AMP)
Marca: Hikari

LP-204129/129



Acoplamento para Coluna de Direção
Hyundai i30
Marca: LP

1146838

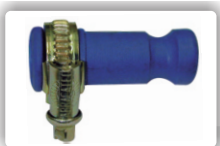

Tampão do Respiro do Catalizador
Gol, Parati, Santana, Logus (Motor AP)
Marca: Kitsbor

DSC1703



Guarnição do Reservatório de Partida
Fiesta, Ecosport - N° Orig. 7S459374/AA
Marca: DSC - Pacote c/ 10 pçs

DSC1709



Guarnição do Reservatório de Partida
Fox, Polo Gol G5 - N° Orig. 5Z0201231-A
Marca: DSC - Pacote c/ 10 pçs

Ga2379



Módulo Hey
Monza, Kadett 92/96 EFI
Similar: 30131 / MTE7746
Marca: Gauss

HAL-55



Fusível MIDI HAL 5500
20/30/40/50/60/70/80/100/120 AMP
Marca: Hikari

YMAX-0235



Bobina de Ignição
Uno, Pálio 1.0 8V EVO 10/...
Similar: 55230507 / EURO 30668
Marca: Ymax

031666/C



Reparo de Injeção Eletrônica
Corsa, Sedan, Wagon 1.6 95/...
Corsa, Sedan 1.0 16V 00/...
Corsa GSI, Tigra 1.6 98/...

Diversos

<p>Conexão da Bomba D'água</p> <p>➡</p>	 <p>LA 435 Monza e Kadett Nº Original: 94.655.119</p>	<p>Anti-chama</p> <p>➡</p>	 <p>AEG2 Anti-chama Palio, Siena, Palio Weekend, Strada 1.0 e 1.5</p>
 <p>NV-019 Anti-chama Corcel Antigo</p>	 <p>NV-020 Anti-chama CHT Moderno</p>	<p>Conexões</p> <p>➡</p>	 <p>NV-029 Conexão p/ Gasolina e Álcool</p>
 <p>NV-129 Conexão de Filtro do Carvão Ativado Linha VW 94/...</p>	 <p>NV-191 Conexão em "y" para mangueira Gol, Voyage, Parati, Saveiro</p>	<p>Funil</p> <p>➡</p>	 <p>AEG3 PT Funil 15 cm Preto</p>
 <p>AEG4 Funil Sanfonado 37cm Vermelho</p>	 <p>AEG4 PT Funil Sanfonado 37cm Preto</p>	<p>Diversos</p> <p>➡</p>	 <p>NV-022 Guia da Vareta de Óleo Linha VW Nº Original: 049.103.663.1</p>
 <p>NV-151 Calota do Cubo da roda traseira Gol, Passat, Parati, Versailles</p>	 <p>KB-1001 Graxa Grafitada Sache com 80 gramas</p>	 <p>KB-1002 Graxa Azul Sache com 40 gramas Para múltiplas aplicações recomendada para uso geral automotivo</p>	



Amortecedor do Porta Malas

CÓDIGO:	MONTADORA:	DESCRIÇÃO DO PRODUTO:	MARCA:	
26004	AUDI	AMORT TAMPA TRAS A3 TAM/CAP,GOLF 98,POLO NV	NATELA	
26698	CITROËN	AMORT TAMPA TRAS BERLINGO	NATELA	
26801		AMORT TAMPA TRAS CITROEN C3	NATELA	
26802		AMORT TAMPA TRAS XSARA PICASSO 05/08	NATELA	
26663		AMORT TAMPA TRAS XSARA PICASSO 99/04	NATELA	
26070		AMORT TAMPA TRAS DOBLO	NATELA	
MQ0447	FIAT	AMORT TAMPA TRAS ELBA TODAS	MULTIQUALITA	
26072		AMORT TAMPA TRAS FIAT 147 1976/1983	NATELA	
26520		AMORT TAMPA TRAS FIAT BRAVA	NATELA	
MQ0449		AMORT TAMPA TRAS IDEA TODOS	MULTIQUALITA	
MQ0424		AMORT TAMPA TRAS MAREA SW 96/07	MULTIQUALITA	
MQ0428		AMORT TAMPA TRAS PALIO 96/NV CORSA,CLT,FOX C/S/ LIMP	MULTIQUALITA	
MQ0448		AMORT TAMPA TRAS PALIO WEEKEND 10/...	MULTIQUALITA	
MQ0435		AMORT TAMPA TRAS PALIO WEEKEND 96/07 C/S/ LIMP	MULTIQUALITA	
26600		AMORT TAMPA TRAS PUNTO	NATELA	
26602		AMORT TAMPA TRAS STILO 01/	NATELA	
MQ0416		AMORT TAMPA TRAS TIPO 88/95	MULTIQUALITA	
MQ0446		AMORT TAMPA TRAS UNO NOVO 10/...	MULTIQUALITA	
MQ0429		AMORT TAMPA TRAS UNO TDS,TIPO,SCENIC C/S/ LIMP	MULTIQUALITA	
26010		FORD	AMORT TAMPA TRAS BELINA TODOS 1968/1989	NATELA
MQ0444			AMORT TAMPA TRAS ECOSPORT .../12	MULTIQUALITA
MQ0410			AMORT TAMPA TRAS ESCORT 84/92 C/LIMP	MULTIQUALITA
MQ0411			AMORT TAMPA TRAS ESCORT 93/96 C/S/ LIMP	MULTIQUALITA
26408	AMORT TAMPA TRAS FIESTA HATCH 08/...		NATELA	
26249	AMORT TAMPA TRAS FIESTA IMP ANT/PEUGEOT 106 /92		NATELA	
26401	AMORT TAMPA TRAS FIESTA SEDAN		NATELA	
26402	AMORT TAMPA TRAS FOCUS 00/02 HATCH		NATELA	
26407	AMORT TAMPA TRAS FOCUS 02/09 HATCH		NATELA	
26406	AMORT TAMPA TRAS FOCUS 02/09 SEDAN		NATELA	
26403	AMORT TAMPA TRAS FOCUS NOVO HATCH		NATELA	
26400	AMORT TAMPA TRAS FOCUS NOVO SEDAN		NATELA	
MQ0432	AMORT TAMPA TRAS FORD KA 97/07 KOMBI 97/...		MULTIQUALITA	
MQ0425	AMORT TAMPA TRAS FUSION 02/		MULTIQUALITA	
26271	AMORT TAMPA TRAS GOL G3/G4/KADETT,MERIVA,ESCORT ZTC		NATELA	
26404	AMORT TAMPA TRAS KA 07/14		NATELA	
26266	AMORT TAMPA TRAS QUANTUM 92/ ROYALE 92/96		NATELA	
26900	HONDA		AMORT TAMPA TRAS HONDA FIT 03/07	NATELA
MQ0458			AMORT TAMPA TRAS HONDA FIT 09/14	NATELA
26286	HYUNDAI		AMORT TAMPA TRAS HB20	NATELA
26098		AMORT TAMPA TRAS TUCSON 2005/...	NATELA	

NA **TELA**



Amortecedor do Porta Malas

CÓDIGO:	MONTADORA:	DESCRIÇÃO DO PRODUTO:	MARCA:	
26284	GM	AMORT TAMPA DIANT BLAZER,S10 95/...TDS - CAPO	NATELA	
MQ0452		AMORT TAMPA DIANT S10,BLAZER (CAPO)	MULTIQUALITA	
26295		AMORT TAMPA DIANT VECTRA TODOS - CAPO	NATELA	
MQ0451		AMORT TAMPA TRAS AGILE TODOS	MULTIQUALITA	
26538		AMORT TAMPA TRAS ASTRA 94/04	NATELA	
26294		AMORT TAMPA TRAS BLAZER/S10 95/...	NATELA	
MQ0434		AMORT TAMPA TRAS CORSA 94/02 C/LIMP	MULTIQUALITA	
MQ0440		AMORT TAMPA TRAS CORSA NOVO 4P 03.../CELTA 00...	MULTIQUALITA	
MQ0414		AMORT TAMPA TRAS CORSA WAGON 97/02	MULTIQUALITA	
26896		AMORT TAMPA TRAS CHEVETTE HATCH 79/87	NATELA	
26012		AMORT TAMPA TRAS CRUZE HATCH 2012/...	NATELA	
26271		AMORT TAMPA TRAS GOL G3/G4/KADETT,MERIVA,ESCORT ZTC	NATELA	
MQ0455		AMORT TAMPA TRAS IPANEMA TODAS	MULTIQUALITA	
MQ0436		AMORT TAMPA TRAS KADETT 89/98 C/LIMP	MULTIQUALITA	
MQ0453		AMORT TAMPA TRAS MERIVA TODAS	MULTIQUALITA	
26675		AMORT TAMPA TRAS ONIX TODOS	NATELA	
MQ0428		AMORT TAMPA TRAS PALIO 96/NV CORSA,CLT,FOX C/S/ LIMP	MULTIQUALITA	
26265		AMORT TAMPA TRAS PARATI GI/GII/GIII,CORSA WIND	NATELA	
26274		AMORT TAMPA TRAS SPIN	NATELA	
26730		AMORT TAMPA TRAS VECTRA 96/05	NATELA	
26729		AMORT TAMPA TRAS VECTRA SEDAN 06/12 GT	NATELA	
MQ0438		AMORT TAMPA TRAS ZAFIRA 99/	MULTIQUALITA	
26249		PEUGEOT	AMORT TAMPA TRAS FIESTA IMP ANT/PEUGEOT 106 /92	NATELA
26731			AMORT TAMPA TRAS PEUGEOT 206 98/	NATELA
26732			AMORT TAMPA TRAS PEUGEOT 206 SW	NATELA
26455			AMORT TAMPA TRAS PEUGEOT 307	NATELA
MQ0439	RENAULT	AMORT TAMPA TRAS CLIO 00/	MULTIQUALITA	
26501		AMORT TAMPA TRAS KANGOO	NATELA	
MQ0445		AMORT TAMPA TRAS SANDERO 07/14	MULTIQUALITA	
MQ0437		AMORT TAMPA TRAS SCENIC 01/	MULTIQUALITA	
MQ0441		AMORT TAMPA TRAS SCENIC 99/00	MULTIQUALITA	
MQ0429		AMORT TAMPA TRAS UNO TDS,TIPO,SCENIC C/S/ LIMP	MULTIQUALITA	
26275	TOYOTA	AMORT TAMPA TRAS ETIOS	NATELA	
26004	VW	AMORT TAMPA TRAS A3 TAM/CAP,GOLF 98,POLO NV	NATELA	
MQ0432		AMORT TAMPA TRAS FORD KA 97/07 KOMBI 97/...	MULTIQUALITA	
MQ0431		AMORT TAMPA TRAS FOX/CROSSFOX 03/	MULTIQUALITA	
26005		AMORT TAMPA TRAS GOL 1.0 80/94 2 MOLAS C/LIMP	NATELA	
26210		AMORT TAMPA TRAS GOL G2 95/99 C/ LIMP	NATELA	
26271		AMORT TAMPA TRAS GOL G3/G4/KADETT,MERIVA,ESCORT ZTC	NATELA	
26006		AMORT TAMPA TRAS GOL G5 TODOS	NATELA	
MQ0413		AMORT TAMPA TRAS GOLF 97/03	MULTIQUALITA	
MQ0428		AMORT TAMPA TRAS PALIO 96/NV CORSA,CLT,FOX C/S/ LIMP	MULTIQUALITA	
MQ0433		AMORT TAMPA TRAS PARATI 84/95 PASSAT 74/89 KOMB 75/96	MULTIQUALITA	
MQ0412		AMORT TAMPA TRAS PARATI 96/	MULTIQUALITA	
26265		AMORT TAMPA TRAS PARATI GI/GII/GIII,CORSA WIND	NATELA	
26008		AMORT TAMPA TRAS POLO HATCH 2002/...	NATELA	
MQ0426		AMORT TAMPA TRAS POLO SEDAN 01/	MULTIQUALITA	
26042		AMORT TAMPA TRAS QUANTUM 86/91	NATELA	
26266		AMORT TAMPA TRAS QUANTUM 92/ ROYALE 92/96	NATELA	
26011		AMORT TAMPA TRAS SPACEFOX 2006/2012	NATELA	
26276		AMORT TAMPA TRAS UP	NATELA	



Tabela Rápida de Conversão e Descrição

Dyna	Uny	VTO	Trico	Valeo	Bosch	Descrição
10 e 46	80.162	PVT13	T010	C046	---	Palheta Universal Traseira 13"
15	80.163	PVT19/ PVT17	T015	C015	B015	Palheta Universal 17" / 19"
17	80.164	PVT23/ PVT18	T017	C017	B017	Palheta Universal 18" / 23"
23 e 323	80.165	PVT23/ PVT19	T023	C071	B023	Palheta Universal 19" / 23"
44 e 56	80.161	PVT18/ PVT18	T056	C056	B056	Palheta Universal 18"
51	80.167	---	---	---	---	Palheta Universal 9,5"
53	80.184	PVT16	T053	C053/C602	B053/H402	Palheta Universal Traseira 16"
128 e 178	80.159	PVT20/ PVT20	T178	C178/C500	---	Palheta Universal 20"
130	80.157	PVT16/ PVT16	T130	C130	B130	Palheta Universal 16"
175	80.181	PVT18	T175	C175	B175	Palheta 18" (Unidade)
180 e 319	80.160	PVT19/ PVT19	T259	C180	B180	Palheta Universal 19"
315	80.188	PVT23/ PVT15	T315	C315	B315	Palheta Universal 15" / 23"
316	80.257	PVT24/ PVT16	T315	C066/C069/C316	601/B315	Palheta Universal 16" / 24"
317	80.256	PVT20/ PVT18	T342	C057	B057	Palheta Universal 18" / 20"
324	80.258	PVT24/ PVT24	T324	C064/C068	B602	Palheta Universal 24"
326	80.189	PVT26/ PVT16	T326	C062	653	Palheta Universal 16" / 26"
340	80.175	PVT21/ PVT19	T017	C052/C340	B340	Palheta Universal 19" / 21"
368	80.255	PVT24/ PVT18	T017	C070/C071	B604	Palheta Universal 18" / 24"
R12	80.207	---	T1002	C501	H300	Refil Palheta Traseira 12"
R13	80.171	---	T1003	C013	---	Refil Palheta Traseira 13"
R14	80.252	---	---	---	H353	Refil Palheta Traseira 14"
R16	80.208	---	T1006	---	H402	Refil Palheta Traseira 16"
R20	80.172	---	T1001	C500	109	Refil Palheta Dianteira 20"
12E	80.196	PVT12	---	---	---	Palheta Traseira 12"
15E	80.199	PVT15	---	---	---	Palheta Traseira 15"
16E	80.200	PVT16	---	---	---	Palheta Traseira 16"
40S	80.180	PVT23/ PVT16	---	CS066	552S	Palheta Universal 23" / 16"

➤ A seguir tabela completa por montadora com códigos Uny, VTO e Wiper.



Encaixe Universal



Palhetas Flex



Para palhetas Flex, substituir na coluna VTO o prefixo PVT por PVF.
Palhetas de borracha com alma em aço de memória, design e tecnologia.

A Palheta do futuro presente no seu carro.

Temos todas as medidas.

Adapta em qualquer veículo com o sistema gancho.

Sistema com trava de segurança.

Palhetas Silicone



**ENCAIXE UNIVERSAL
DIANTEIRO**

CÓDIGO	DESCRIÇÃO
PL013	PALHETA UNIVERSAL FLEX 13" UNIDADE
PL015	PALHETA UNIVERSAL FLEX 15" UNIDADE
PL016	PALHETA UNIVERSAL FLEX 16" UNIDADE
PL018	PALHETA UNIVERSAL FLEX 18" UNIDADE
PL019	PALHETA UNIVERSAL FLEX 19" UNIDADE
PL020	PALHETA UNIVERSAL FLEX 20" UNIDADE
PL021	PALHETA UNIVERSAL FLEX 21" UNIDADE
PL022	PALHETA UNIVERSAL FLEX 22" UNIDADE
PL023	PALHETA UNIVERSAL FLEX 23" UNIDADE
PL024	PALHETA UNIVERSAL FLEX 24" UNIDADE
PL026	PALHETA UNIVERSAL FLEX 26" UNIDADE

CÓDIGO	DESCRIÇÃO
PL010E	PALHETA TRASEIRA FLEX 10" COM ENCAIXE UNIVERSAL
PL012E	PALHETA TRASEIRA FLEX 12" COM ENCAIXE UNIVERSAL
PL013E	PALHETA TRASEIRA FLEX 13" COM ENCAIXE UNIVERSAL
PL014E	PALHETA TRASEIRA FLEX 14" COM ENCAIXE UNIVERSAL
PL015E	PALHETA TRASEIRA FLEX 15" COM ENCAIXE UNIVERSAL
PL016E	PALHETA TRASEIRA FLEX 16" COM ENCAIXE UNIVERSAL



**ENCAIXE UNIVERSAL
TRASEIRO**



Resultados **EXCELENTES** mesmo diante de condições meteorológicas **EXTREMAS!**

REFERÊNCIA	ESPECIFICAÇÕES	FERRO (PAR)
YN-PF0010	PALHETA DE FERRO 10" (C/ ENCAIXE PARAFUSO P/ FUSCA)	
YN-PF0013	PALHETA DE FERRO 13"	
YN-PF0016	PALHETA DE FERRO 16"	
YN-PF0018	PALHETA DE FERRO 18"	
YN-PF0019	PALHETA DE FERRO 19"	
YN-PF0020	PALHETA DE FERRO 20"	
YN-PF0022	PALHETA DE FERRO 22"	
YN-PF0024	PALHETA DE FERRO 24"	
YN-PF1523	PALHETA DE FERRO 15" + 23" (FOX)	
YN-PF1822	PALHETA DE FERRO 18" + 22" (PALIO)	
YN-PF1921	PALHETA DE FERRO 19" + 21" (GOL)	

REFERÊNCIA	ESPECIFICAÇÕES	SILICONE
YN-PS1610	PALHETA DE SILICONE 10"	
YN-PS1613	PALHETA DE SILICONE 13"	
YN-PS1614	PALHETA DE SILICONE 14"	
YN-PS1615	PALHETA DE SILICONE 15"	
YN-PS1616	PALHETA DE SILICONE 16"	
YN-PS1617	PALHETA DE SILICONE 17"	
YN-PS1618	PALHETA DE SILICONE 18"	
YN-PS1619	PALHETA DE SILICONE 19"	
YN-PS1620	PALHETA DE SILICONE 20"	
YN-PS1621	PALHETA DE SILICONE 21"	
YN-PS1622	PALHETA DE SILICONE 22"	
YN-PS1623	PALHETA DE SILICONE 23"	
YN-PS1624	PALHETA DE SILICONE 24"	
YN-PS1626	PALHETA DE SILICONE 26"	

Específicas



PVF1917 - VTO
Palheta Par
Ford: Ka 11/...



PVF2116 - VTO
Palheta Par
Ford: Fiesta 11/...



PVF2118 - VTO
Palheta Par
GM: Agile 11/...



PVF2119 - VTO
Palheta Par
VW: Golf 08/...



PVF2218 - VTO
Palheta Par
GM: Vectra 08/...



PVF2414 - VTO
Palheta Par
Fiat: 500



PVF2415 - VTO
Palheta Par
Fiat: Idea 11/...



PVF2415H - VTO
Palheta Par
Honda: City 01/...



PVF2416 - VTO
Palheta Par
Renault: Fluence 11/...



PVF2418 - VTO
Palheta Par
Renault: Symbol 11/...



PVF2419 - VTO
Palheta Par
VW: Jetta 07/...



PVF2419B - VTO
Palheta Par
Audi: A3, A3 Sportback
BMW: 320i, 325i



PVF2420 - VTO
Palheta Par
Audi: A4



PVF2516 - VTO
Palheta Par
Ford: New Fiesta 11/...



PVF2613 - VTO
Palheta Par
Honda: New Fit 09/...



PVF2615 - VTO
Palheta Par
Fiat: Linea, Punto 08/...



PVF2617 - VTO
Palheta Par
Ford: Focus 09/...



PVF2724 - VTO
Palheta Par
Honda: New Civic 07/...



PVF2824 - VTO
Palheta Par
Citroën: C4



PVF2826 - VTO
Palheta Par
Peugeot: 307 08/...



AUDI

YN-PS2420A	PALHETA ESPECÍFICA AUDI A3 07 / HYUNDAI EQUUS 11, LAND ROVER FREELANDER 2
YN-PS2420E	PALHETA ESPECÍFICA AUDI A4/A5 12> / HYUNDAI VERA CRUZ, HYUNDAI SANTA FÉ 08>
YN-PS1529	PALHETA ESPECÍFICA AUDI A1 11> (2414E)
YN-PS1396	PALHETA ESPECÍFICA AUDI A3 SPORTBACK 07/12 (2418B) / BMW SERIE 3 10/12, SERIE 3 CABRIO/COUPE/TOURING 10/12, X1 10/15

BMW

YN-PS1396	PALHETA ESPECÍFICA BMW SERIE 3/CABRIO/COUPE/TOURING 10/12 (2418B) / AUDI A3 SPORTBACK 07/12
YN-PS1397	PALHETA ESPECÍFICA BMW SÉRIE 1 04-11 (2020A)
YN-PS1398	PALHETA ESPECÍFICA BMW SÉRIE 1 12> (2118A)

CHEVROLET

YN-PS2118D	PALHETA ESPECÍFICA CHEVROLET AGILE 11, MONTANA 11
YN-PS2218C	PALHETA ESPECÍFICA CHEVROLET VECTRA 08, VECTRA GT 07, VECTRA GTX 07
YN-PS2218D	PALHETA ESPECÍFICA CHEVROLET S10 12, TRAILBLAZER 13
YN-PS2414D	PALHETA ESPECÍFICA CHEVROLET ONIX 18, PRISMA 18
YN-PS2615A	PALHETA ESPECÍFICA CHEVROLET OMEGA 08, SONIC 12 / FIAT LINEA 08, FIAT PUNTO 08 / PEUGEOT 2008 14, 208 12
YN-PS2416B	PALHETA ESPECÍFICA CHEVROLET ONIX, PRISMA 19> / C3 AIRCROSS 11, C3 PICASSO 11 / FIAT PALIO 12, GRAN SIENA 12
YN-PR1198	PALHETA ESPECÍFICA CHEVROLET CRUZE SPORT 17 (2828B) / FORD FOCUS 2014
YN-PR1199	PALHETA ESPECÍFICA CHEVROLET COBALT 11
YN-PS1402	PALHETA ESPECÍFICA CHEVROLET MALIBU 10/11 (2421B) / VW TIGUAN 09/16

CITROEN

YN-PS2416B	PALHETA ESPECÍFICA CITROEN C3 AIRCROSS 11, C3 PICASSO 11 / FIAT PALIO 12, GRAN SIENA 12 / GM ONIX, PRISMA 19..
YN-PS2824A	PALHETA ESPECÍFICA CITROEN C4 HATCH 09, C4 PALLAS 05
YN-PS1394	PALHETA ESPECÍFICA CITROEN C5/C5 BREAK 08-13 (2821A)
YN-PS1524	PALHETA ESPECÍFICA CITROEN C5/C5 BREAK 04-07 (2618C)
YN-PS2414B	PALHETA ESPECÍFICA CITROEN C4 AIRCROSS 11 / CITY/FIT 09/14

FIAT

YN-PS2415D	PALHETA ESPECÍFICA FIAT IDEA 11, IDEA ADVENTURE 11
YN-PS2416A	PALHETA ESPECÍFICA FIAT NOVO UNO 15>, ARGO 17
YN-PS2416B	PALHETA ESPECÍFICA FIAT PALIO 12, GRAN SIENA 12 / C3 AIRCROSS 11, C3 PICASSO 11, ONIX, PRISMA 19..
YN-PS2615A	PALHETA ESPECÍFICA FIAT LINEA 08, PUNTO 08 / OMEGA 08, SONIC 12, PEUGEOT 2008 14, 208 12
YN-PS2418B	PALHETA ESPECÍFICA FIAT BRAVO 11 / VW EOS 08/11
YN-PS1395	PALHETA ESPECÍFICA FIAT IDEA, IDEA ADVENTURE 14> (2415A)

FORD

YN-PS1917D	PALHETA ESPECÍFICA FORD KA 10
YN-PS2116A	PALHETA ESPECÍFICA FORD FIESTA BRASILEIRO 11
YN-PS2216D	PALHETA ESPECÍFICA FORD ECOSPORT 13
YN-PS2615B	PALHETA ESPECÍFICA FORD NEW FIESTA 09>17
YN-PS2617C	PALHETA ESPECÍFICA FORD FOCUS 08 / PEUGEOT 207 CC 08/12
YN-PR1198	PALHETA ESPECÍFICA FORD FOCUS 2014 (2828B) / GM CRUZE SPORT 17
YN-PS1401	PALHETA ESPECÍFICA FORD RANGER 17> (2415B)



HONDA

- YN-PS2414B** PALHETA ESPECÍFICA HONDA CITY/FIT 09/14 / CITROEN C4 AIRCROSS 11
- YN-PS2616G** PALHETA ESPECÍFICA HONDA CR-V
- YN-PS2623F** PALHETA ESPECÍFICA HONDA NEW CIVIC 07>12
- YN-PS2624B** PALHETA ESPECÍFICA HONDA CIVIC 07>11
- YN-PR1196** PALHETA ESPECÍFICA HONDA FIT 09>14 (2614B) / GM TRACKER 2014

HYUNDAI

- YN-PS2419B** PALHETA ESPECÍFICA HYUNDAI VERA CRUZ 08 / VW JETTA, VW JETTA VARIANT 08, PASSAT CC08, PASSAT VARIANT 05
- YN-PS2416F** PALHETA ESPECÍFICA HYUNDAI HB20 PREMIUM 13 / MITSUBISHI OUTLANDER / SUZUKI VITARA
- YN-PS2420A** PALHETA ESPECÍFICA HYUNDAI EQUUS 11 / AUDI A3 07 / LAND ROVER FREELANDER 2

JEEP

- YN-PR1197** PALHETA ESPECÍFICA JEEP RENEGADE 15 (2220B)

LAND ROVER

- YN-PS2420A** PALHETA ESPECÍFICA LAND ROVER FREELANDER 2 / AUDI A3 07, HYUNDAI EQUUS 11

MITSUBISHI

- YN-PS1918F** PALHETA ESPECÍFICA MITSUBISHI PAJERO TR4, L200 OUTDOOR, GRAN VITARA
- YN-PS2017F** PALHETA ESPECÍFICA MITSUBISHI COLT
- YN-PS2218F** PALHETA ESPECÍFICA MITSUBISHI PAJERO DAKAR, PAJERO FULL/TRITON/ALL
- YN-PS2416F** PALHETA ESPECÍFICA MITSUBISHI OUTLANDER / SUZUKI VITARA / HYUNDAI HB20 PREMIUM 13
- YN-PS2421F** PALHETA ESPECÍFICA MITSUBISHI ASX, LANCER, OUTLANDER

MERCEDES

- YN-PS2622A** PALHETA ESPECÍFICA MERCEDES A200 06>, B200 06>, SPRINTER 13>
- YN-PS1399** PALHETA ESPECÍFICA MERCEDES CLASSE SLK 05-11 (2121A)
- YN-PS1526** PALHETA ESPECÍFICA MERCEDES CLASSE C 09/14 (2424C)
- YN-PS1527** PALHETA ESPECÍFICA MERCEDES CLASSE CLS 05/11, CLASSE E 02/08, CLASSE SL 01-12 (2626C)
- YN-PS1528** PALHETA ESPECÍFICA MERCEDES CLASSE E 09/12, CLASSE E CABRIOLET 10/12 (2624C)

NISSAN

- YN-PS2815G** PALHETA ESPECÍFICA NISSAN SENTRA 14>

PEUGEOT

- YN-PS2826A** PALHETA ESPECÍFICA PEUGEOT 307 06
- YN-PS2826B** PALHETA ESPECÍFICA PEUGEOT 3008 11, 308 12, 408 12, 508 12, DS5 13>
- YN-PS2615A** PALHETA ESPECÍFICA PEUGEOT 2008 14, 208 12 / FIAT LINEA 08 PUNTO 08/ GM OMEGA 08, SONIC 12
- YN-PS2617C** PALHETA ESPECÍFICA PEUGEOT 207 CC / FORD FOCUS 08
- YN-PS1403** PALHETA ESPECÍFICA PEUGEOT 508 12-14 (2626B)
- YN-PS1525** PALHETA ESPECÍFICA PEUGEOT 407/407 SW 04-09 (2828C)

RENAULT

- YN-PS2220H** PALHETA ESPECÍFICA RENAULT SANDERO, LOGAN 14>
- YN-PS1332** PALHETA ESPECÍFICA RENAULT FLUENCE 10/17, CLIO3 05/12, MEGANE MK3 08/16
- YN-PS2417H20615** PALHETA ESPECÍFICA RENAULT SYMBOL 08/12
- YN-PS1332** PALHETA ESPECÍFICA RENAULT FLUENCE (2416H)
- YN-PS1521** PALHETA ESPECÍFICA RENAULT CAPTUR 16/20 (2615M)



SUZUKI

YN-PS1816F	PALHETA ESPECÍFICA SUZUKI JIMNY
YN-PS2416F	PALHETA ESPECÍFICA SUZUKI VITARA /OUTLANDER /HYUNDAI HB20 PREMIUM 13

TOYOTA

YN-PS0026T	PALHETA ESPECÍFICA TOYOTA ETIOS SEDAN / HATCH / ESPORTIVO
YN-PS2614F	PALHETA ESPECÍFICA TOYOTA COROLLA 08, COROLLA 09/15, RAV4 04, RAV4 15>
YN-PS2216F	PALHETA ESPECÍFICA TOYOTA HILUX 15/18

VOLVO

YN-PS2620B	PALHETA ESPECÍFICA VOLVO
YN-PS2620E	PALHETA ESPECÍFICA VOLVO XC60 08>, V70 08>, S80 06>, S40 06>, C30 06>
YN-PS1400	PALHETA ESPECÍFICA VOLVO S60 04/10, V70 04/07, XC70/XC90 05/07 (2421A) /SMART FORTWO 06/15

VW

YN-PS2119B	PALHETA ESPECÍFICA VW POLO GTI 09, POLO SEDAN 10, POLO GTI BLUE 09
YN-PS2119C	PALHETA ESPECÍFICA VW GOLF IV 08/14
YN-PS2215E	PALHETA ESPECÍFICA VW CROSSFOX 13, FOX 13, SPACEFOX 13
YN-PS2216E	PALHETA ESPECÍFICA VW GOL GVI 13, SAVEIRO 13, VOYAGE 13, UP
YN-PS2419B	PALHETA ESPECÍFICA VW JETTA 07, JETTA VARIANT 08, PASSAT CC 08, PASSAT VARIANT 05 /HYUNDAI VERA CRUZ 08
YN-PS2419E	PALHETA ESPECÍFICA VW JETTA 13/PASSAT13
YN-PS2424E	PALHETA ESPECÍFICA VW AMAROK 13
YN-PS2618E	PALHETA ESPECÍFICA VW GOLF 14
YN-PS2418B	PALHETA ESPECÍFICA VW EOS 08/11 /FIAT BRAVO 11
YN-PS1333	PALHETA ESPECÍFICA VW UP 14 (2416E)
YN-PS1402	PALHETA ESPECÍFICA VW TIGUAN 09/16 (2421B) /CHEVROLET MALIBU 10/11



Palhetas

VTO WIPER AUTOMOTIVOS



Palhetas Caminhão

VTO AUTOMOTIVOS

CÓDIGO	APLICAÇÃO
PVC 2400	SCANIA: Série P 96/98, Série T/R 91/98
PVC 2472	MERCEDES-BENZ: Série L (L, LA, LK, LAK, LS, LB Gancho) VOLKSWAGEN: Caminhões
PVC 2474	AGRALE: 6000 92/..., 7500TDX, 7000DX, MA 7.5T 92/..., 8500 97/... VOLKSWAGEN: Caminhões MERCEDES-BENZ: 709, 710, 914, 114, 88/... 721C 98/... cara chata (12,13,14,17,24) 97/... Série L 88/00 Série L Pesada SCANIA: Série T/R 81/90
PVC 2662 (antigo PVC2097)	AGRALE: 1600D, 1800D 86/91, 4500D, 5000, D510 - Deutz 92/... MERCEDES-BENZ: Série L3 Limpadores, 608, 708 75/88, Ategor, Axor PUMA: T4, T6 VOLKSWAGEN: Caminhões 81/92 IVECO: Stralis, Trakker, Tech VOLVO: FH12 94/...
PVC 2768	SCANIA: Série 4 (T/P/R) 98/...



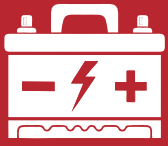

Cabo de Transferência / Chupeta

C-001
200 AMP
2,5 metros



C-004
400 AMP
2,5 metros



ETE7252P - Preta
ETE7252V - Vermelha
Garra Bateria Grande
5,5" / 14cm



ETE7252P/P - Preta
ETE7252V/P - Vermelha
Garra Bateria Média
2,2" / 5,5cm



Z-307
Carregador de Bateria
Lâmpada



EZ-307
Carregador de Bateria
Eletrônico - Bivolt



P-LED/GA
Pendente 18 LEDs
Garra Bateria 12V - 3 metros

BLISTER



P-LED/BV
Pendente 18 LEDs
Tomada Bivolt 110/220V - 3 metros





BLISTER

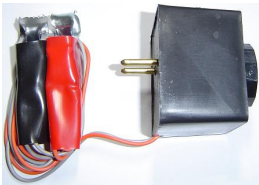

P-LED/AC
Pendente 18 LEDs
Acend. Cigarro 12V - 3 metros

BLISTER

Acessórios Diversos

<p>Acessórios</p> 	<p>Walcabos</p>  <p>CB109 Carregador de Bateria Eletrônico 110/220 volts</p>	
	 <p>RD21073 Acendedor de Cigarro Universal Modelo Antigo</p>	 <p>SKY6313 Acendedor de Cigarro Universal Modelo Moderno</p>
<p>A-INT Antena Interna Universal</p> 	 <p>902800 Triângulo de Segurança Base de Ferro - com Estojo Plástico</p>	



Chave de Roda e Vela



CR-17L
Chave de Roda L 17"
Sem espátula



CR-19L
Chave de Roda L 19"
Sem espátula



CR-CRUZ
Chave de Roda Cruz
Com espátula



CV-16C
Chave de Vela Curta
16 mm



CV-16L
Chave de Vela Longa
16 mm

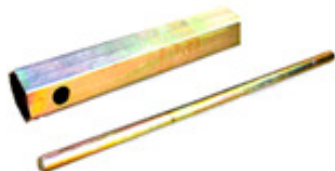

CV-21C
Chave de Vela Curta
21 mm



CV-21L
Chave de Vela Longa
21 mm



Macacos

Macacos Hidráulicos



M-H2TON
Macaco Hidráulico tipo Garrafa
com capacidade para até 2 toneladas
Acompanha maleta para transporte
Marca: Hulk



M-H4TON
Macaco Hidráulico tipo Garrafa
com capacidade para até 4 toneladas
Acompanha maleta para transporte
Marca: Hulk



M-J2TON
Macaco Hidráulico tipo Jacaré
com capacidade para até 2 toneladas
Acompanha maleta para transporte
Marca: Hulk

Macacos Joelho



M-J600
Macaco Joelho Leve
com capacidade para até 600 kg
Marca: Andorinha



M-J800
Macaco Joelho Leve
com capacidade para até 800 kg
Marca: Andorinha



M-JUNO
Macaco Joelho Uno, Fiat 147
com capacidade para até 800 kg
Marca: Andorinha

Macacos Sanfona



M-SU
Macaco Sanfona Universal
com capacidade para até 2.000 kg
Marca: Andorinha



M-SK
Macaco Sanfona Kombi
com capacidade para até 2.500 kg
Marca: Andorinha





C-U5



CONECTOR UNIVERSAL RETO
FINO (5")

C-U7



CONECTOR UNIVERSAL RETO
GROSSO (7")

C-U5/90



CONECTOR UNIVERSAL 90°
FINO (5")

C-U7/90



CONECTOR UNIVERSAL 90°
GROSSO (7")

DSC 5081



CONECTOR P/ TUBO DE COMBUSTIVEL
FIAT/GM RETO - CINZA

DSC 5082



CONECTOR P/ TUBO DE COMBUSTIVEL
FIAT/GM 90° - CINZA

DSC 2065



CONEXÃO MANGUEIRAS DA FLAUTA
MOTOR ENDURA: KA, FIESTA, COURIER

DSC 2314



KIT REPARO BICO INJETOR M. MARELLI
FOX, GOL POWER BICO IWP 170 / 176

E-0585



TAMPA OLEO DO MOTOR
PALIO, STRADA FIRE 8V - AMARELA

E-0584



TAMPA OLEO DO MOTOR
PALIO, STRADA ETC FIRE 16V - PRETA

K825



BOMBA PART FRIO GAS/AGUA 1 SAIDA
GOL G5, GOLF, FOX - ORIGINAL CEBI

K826



BOMBA RESERV. PARA-BRISA 2 SAIDAS
GOL G5, GOLF, FOX - ORIGINAL CEBI

C-484



BOTAO TIC-TAC PRETO
REDONDO 10A

C-485



BOTAO TIC-TAC PRETO
QUADRADO 10A

DSC1902



BOTAO PARTIDA / START UNIVERSAL
M. BENZ, TOYOTA, FIAT UTIL/CAMINHÃO

HZ-7060



SENSOR HALL C/ 3 PINOS - VW AP MI
GOL, SAVEIRO, PARATI, SANTANA, KOMBI

CV-16C



CHAVE DE VELA CURTA
BOCA DE 16" - BELLOSA

CV-16L



CHAVE DE VELA LONGA
BOCA DE 16" - BELLOSA

CV-21C



CHAVE DE VELA CURTA
BOCA DE 21" - BELLOSA

CV-21L



CHAVE DE VELA LONGA
BOCA DE 21" - BELLOSA

914 1022



ABRAÇADEIRA COIFA UNIVERSAL PEQ.
AÇO CARBONO - LINEAR 24,5 cm

914 1023



ABRAÇADEIRA COIFA UNIVERSAL MED.
AÇO CARBONO - LINEAR 35,0 cm

914 1024



ABRAÇADEIRA COIFA UNIVERSAL GDE.
AÇO CARBONO - LINEAR 45,0 cm

A-ZIP20179



ABRAÇADEIRA COIFA UNIVERSAL PEQ.
INOX - LINEAR 20,1 cm X 0,79 cm

A-ZIP50080



ABRAÇADEIRA COIFA UNIVERSAL GDE.
INOX - LINEAR 50,0 cm X 0,8 cm

L-H1624



LÂMPADA H16 12V MILHA
PEUGEOT 208/307, C3/C4, ETIOS, LOGAN

401 0167



REP. SEMI-EIXO LADO RODA
DUSTER 12/ RENEGADE, TORO,
FREMONT

501 0203



REP. SEMI-EIXO LADO CÂMBIO-TRIPOIDE
DUSTER 12/... - TODOS



Tabela de Prazos e Descontos



Valor de Compra	Cód. Pg.	Prazo
R\$ 250,00 à R\$ 349,99	6	28 dias
R\$ 350,00 à R\$ 499,99	7	30 dias
R\$ 500,00 à R\$ 749,99	8	32 dias
	9	28/35 dias
R\$ 750,00 à R\$ 999,99	12	35 dias
	13	28/42 dias
	14	28/35/42 dias
R\$ 1.000,00 à R\$ 1.499,99	20	28/35/42/49 dias
	21	28/38/48 dias
	22	30/40/50 dias
	23	35/42 dias
	24	39 dias
R\$ 1.500,00 à R\$ 1.999,99	34	28/35/42/49/56 dias
	35	28/42/56 dias
	36	35/42/49 dias
	37	42 dias
R\$ 2.000,00 à R\$ 2.999,99	50	28/35/42/49/56/63 dias
	51	30/40/50/60 dias
	52	30/45/60 dias
	53	30/60 dias
	54	45 dias
R\$ 3.000,00 à R\$ 4.999,99	64	28/35/42/49/56/63/70/77 dias
	65	28/35/42/49/56/63/70 dias
	66	30/40/50/60/70 dias
	67	28/42/56/70 dias
	68	30/45/60/75 dias
	69	30/50/70 dias
	70	50 dias
Acima de R\$ 5.000,00	78	28/35/42/49/56/63/70/77/84/91 dias
	79	28/35/42/49/56/63/70/77/84 dias
	80	30/40/50/60/70/80/90 dias
	81	30/40/50/60/70/80 dias
	82	30/45/60/75/90 dias
	83	30/60/90 dias
84	60 dias	



Pagamentos à Vista

Valor de Compra	Cód. Pg.	Prazo	Desconto
R\$ 250,00 à R\$ 1.499,99	2	Depósito Antecipado (Novos Clientes) ou Boleto 7 dias	2%
Acima de R\$ 1.500,00	3		3%

➤ Prazos de Pagamento e Descontos serão determinados pelo valor do pedido faturado/entregue.



CANAIS DE COMUNICAÇÃO NCK



(19) 3238.8082
3238.8094



(19) 99246.6452

e-mail vendas: vendas@nckdistribuidora.com.br

e-mail administrativo: nckdistribuidora@nckdistribuidora.com.br

Consulta de Produtos e Catálogo Completo em PDF:

www.nckdistribuidora.com.br

A NCK Distribuidora tem como objetivo satisfazer as expectativas do cliente,
fornecendo produtos com a qualidade e eficiência a preço justo.

